

TerraSync™

Operation Guide

Version 2.20

July 2002

Revision A

Trimble Navigation Limited
Mapping & GIS Division
645 North Mary Avenue
Post Office Box 3642
Sunnyvale, CA 94085
U.S.A.

Phone: +1-408-481-8940
1-800-545-7762
Fax: +1-408-481-7744
www.trimble.com

Contents

Using the TerraSync Operation Guide

OVERVIEW

Introduction

System requirements

TerraSync documentation

INSTALLATION

Installing TerraSync on a CE device

Installing TerraSync on a PC

TerraSync Updater utility

TUTORIAL

Preparing for data collection

Data collection

Processing the data

Preparing for data update

Data update

ADVANCED FUNCTIONS

Advanced data collection

Coordinate systems

REFERENCE

General operation

The Map section

The Data section

The Navigation section

The Status section

The Setup section

TROUBLESHOOTING

GLOSSARY

INDEX

LEGAL INFORMATION



Using the TerraSync Operation Guide

More...

indicates more information about the current topic. Click More... to move to the remaining information.

green text

indicates a link to a related topic.

To follow a link: Position the pointer over green or red text. It changes to .

Click the left mouse button to go to the page containing the highlighted topic.

red text

indicates a link to the glossary.

blue text

indicates a link to a Web page, ftp site, or e-mail address.



Document Conventions

This font and color represents information that you enter in a software screen.

This font and color represents messages displayed on the screen of the field computer.

This font and color identifies a software command button.

Warnings, Notes, and Tips

Warnings, notes, and tips draw attention to important information and indicate its nature and purpose.

WARNING Warnings alert you to situations that could cause personal injury, hardware damage, unrecoverable data loss, or software error.

NOTE Notes give additional significant information about the subject to increase your knowledge or guide your actions.

TIP Tips indicate a shortcut or other time- or labor-saving hint that can help you make better use of the product.



OVERVIEW

This overview provides general information about the TerraSync™ software. The overview is divided into three sections:

- **Introduction** explains how to use the TerraSync software and provides an overview of what you can do with it.
- **System requirements** outlines the specifications required for a computer to run the TerraSync software.
- **TerraSync documentation** lists the documentation available with the TerraSync software.



Introduction

Welcome to the TerraSync software. The TerraSync software is designed for collecting and updating geographical data on a field computer. A field computer is one of the following:

- a Windows CE device (a **handheld PC 2000**, **handheld PC (Professional)**, **palm-size PC**, or **Pocket PC** running the Windows CE operating system)
- a PC (a desktop or laptop computer running a supported Windows desktop operating system)

You can connect a GPS receiver to a field computer that has the TerraSync software installed and use TerraSync to track GPS status, log data, and update existing data.

This section introduces you to the TerraSync software. The topics covered include:

- **What is the TerraSync software?**
- **What can you do with the TerraSync software?**
- **TerraSync Standard edition software**
- **Using the TerraSync software**



What is the TerraSync software?

The TerraSync software is designed for collecting and updating GIS and spatial data. The TerraSync software acts as the **controlling software**. It communicates with a Trimble GPS receiver connected to the field computer, allowing you to set GPS parameters in the receiver, record GPS positions on the field computer, and maintain existing GIS data.

The TerraSync software can be used with a wide variety of real-time sources of differential corrections, including integrated beacon, integrated satellite, integrated WAAS, an external radio, or a Beacon-on-a-Belt (BoB™) receiver.

The TerraSync software provides mission planning in the field and data dictionary creation and editing. The GPS Pathfinder Office software works with the TerraSync software, providing advanced mission planning and data dictionary creation, as well as data transfer, data import and export, and postprocessing.



What can you do with the TerraSync software?

The primary functions of the TerraSync software are:

- updating existing GIS data
- collecting data for a GIS or spatial database
- navigating in the field

The functions of the TerraSync software are divided into sections.

Use the Data section to update data from an existing GIS, CAD, or spatial database. You can review, edit, and update the positions and attributes for features. You can filter your data to identify the features required for data maintenance.

You can also use the Data section to accurately and efficiently collect the attributes and GPS position of geographic points, lines, and areas. This information is stored in one or more data files that you can transfer to Trimble's GPS Pathfinder Office software for **postprocessing** and editing, or to the GPS Pathfinder Express service for postprocessing. Data can then be exported into a wide range of GIS-compatible formats.



Use the Map section or the Navigation section to navigate to specific locations. You can use **real-time differential GPS** to optimize navigation and provide in-field differential accuracy. The TerraSync software is compatible with a range of real-time correction sources.

The Map section shows you all the features in your data file. A raster or vector map can be displayed in the background for reference.

Use the Setup section to control how the TerraSync software interacts with the GPS receiver and any real-time correction sources, and also to configure data collection and display settings.

Use the Status section to view summary or detailed information about the software, your GPS receiver, any real-time source you have configured, and the location and health of the satellites your receiver is tracking.



TerraSync Standard edition software

The TerraSync Standard edition is a limited version of the TerraSync software. If you have purchased TerraSync Standard edition, the following restrictions apply:

- You cannot open imported data files. This applies to:
 - SSF files transferred to TerraSync Standard edition using the Data Transfer utility
 - Data files created by reading from Shapefiles
 - Data files received by e-mail

NOTE TerraSync Standard edition does not let you update data files that you have created in TerraSync but not yet transferred from your field computer. The usual restriction on updating GPS positions in files older than one week still applies.

- You cannot display a background image or data file in the Map section.
- External sensors (including laser rangefinders) are not supported.

You can upgrade the TerraSync Standard edition software to the TerraSync Professional edition, which provides the full TerraSync functionality. To do this, contact your local Trimble dealer.

This manual describes the TerraSync Professional edition software. If a feature or option it describes is not available in the TerraSync Standard edition software, this is indicated with a note at the beginning of the relevant section.





Using the TerraSync software

The TerraSync software is arranged in the following five *sections*:

-  **The Map section**
-  **The Data section**
-  **The Navigation section**
-  **The Status section**
-  **The Setup section**

One of these sections is always active and visible. The Section list button shows the section that is currently active. You can move between sections at any time without closing any open forms or screens. To switch to a different section, tap the Section list button and then select the section you want from the drop-down list.

For example, to switch from the Map section to the Data section, tap the Section list button and then select  Data. The button now shows  Data, and the Data section becomes the active section. When you return to the Map section, the screen or form that was open when you left appears again.

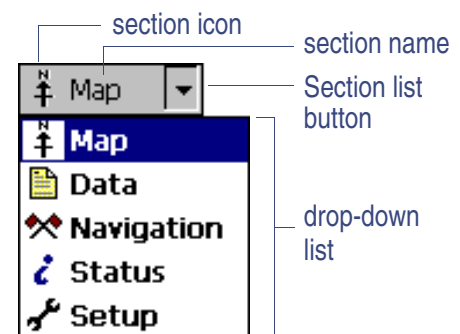

TIP You can also use **Keyboard shortcuts** to move between sections.



Panes

If you use TerraSync on a field computer with a screen size of 640 x 240 or larger, the screen is arranged in panes. Each pane displays a section of the software.

Depending on the screen resolution, up to three panes can be displayed. By default, when the TerraSync software opens, the Map, Data, and Status sections are displayed.

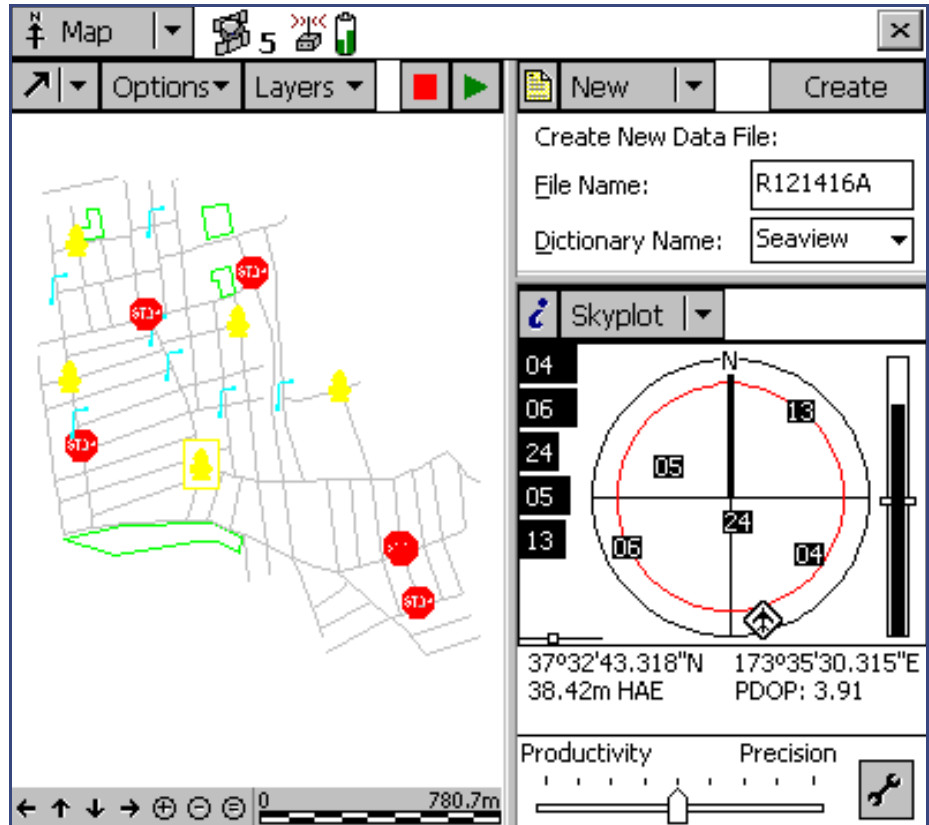

More...



To change the size of a pane, drag the resize bar between it and the next pane. Each pane has a minimum size, so if resizing would make a pane smaller than its minimum dimensions, it is automatically hidden. You can use this feature to create three-pane, two-pane, or single-pane layouts.

The Section list button controls the section that appears in the **primary** pane (the left pane, or the top pane if only two panes are visible). To change the section that is displayed in that pane, tap the Section list button and then select the section you want from the list as usual. If the section you select is already displayed in another (**secondary**) pane, the two sections swap position.

A mini Section button appears in the top left corner of all other panes. To change the section that is displayed in one of these panes, tap the mini Section list button and then select the section you want from the list.

To change the position of the sections that are visible, tap and hold the mini Section button. The icon for the section appears. Drag this icon into the pane where you want this section displayed. When you drop the icon, the two sections swap position.

mini Section button

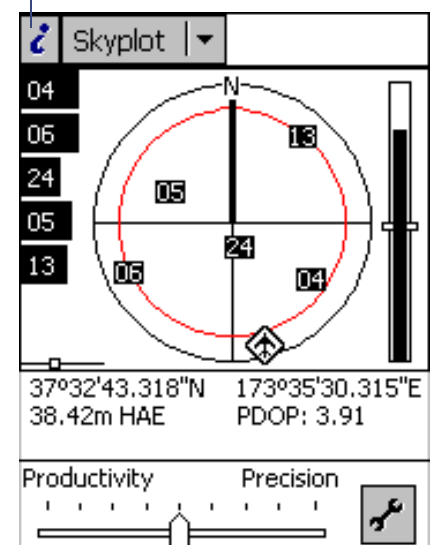

Section structure

Some sections have a number of **subsections**. If the current section has subsections, the Subsection list button is visible. You can switch to a different subsection in the current section at any time by tapping the Subsection list button and selecting the subsection you want from the drop-down list.

For example, if you are in the Skyplot subsection of the Status section, the Subsection button displays Skyplot. If you want to switch to the Satellite Information subsection, tap the Subsection list button and select Satellite Information.

Some subsections are not available all the time. For example, in the Data section, you cannot open the Collect Features subsection until you open or create a data file.

Some screens also contain buttons and menu buttons that let you open other screens or forms.

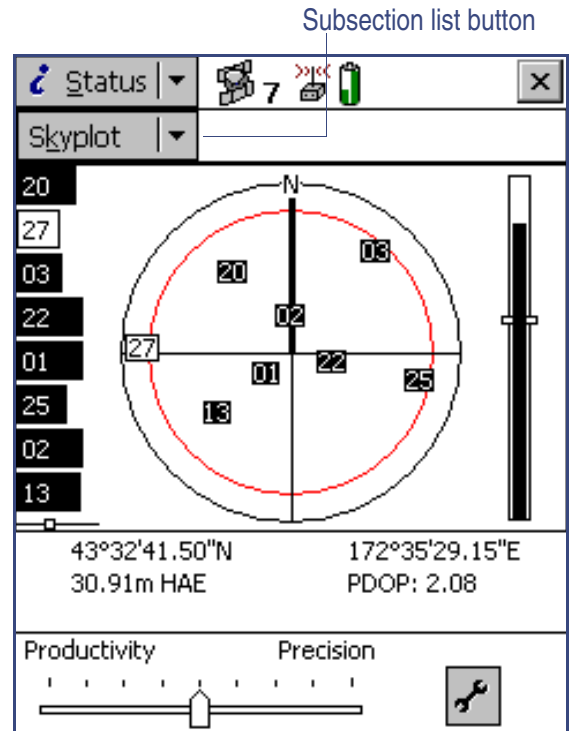

More...



The next five diagrams show an outline of the TerraSync section structure. Use them as a handy reference until you are familiar with the sections and their subsections.

Map Section

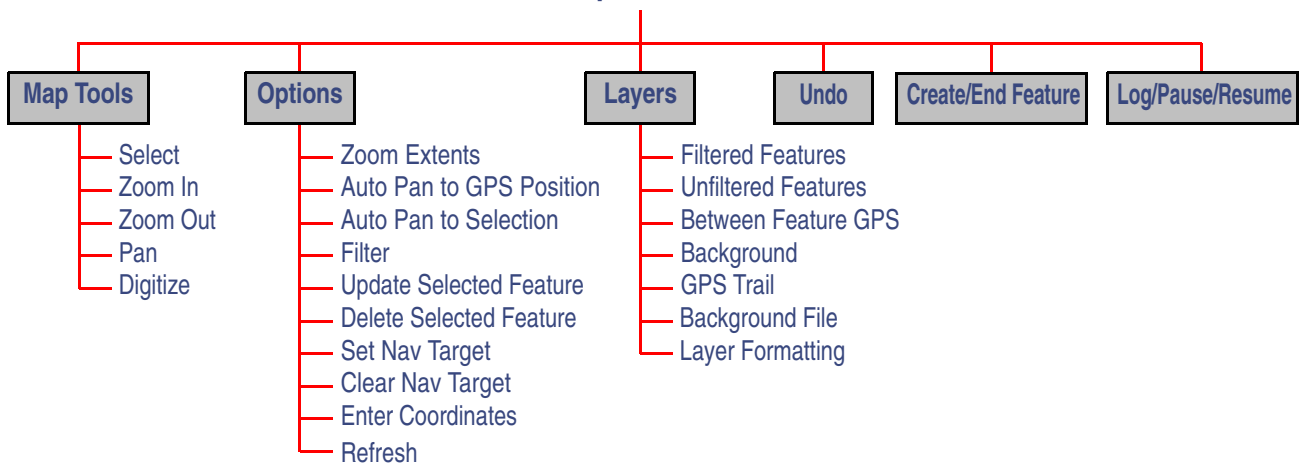

More...



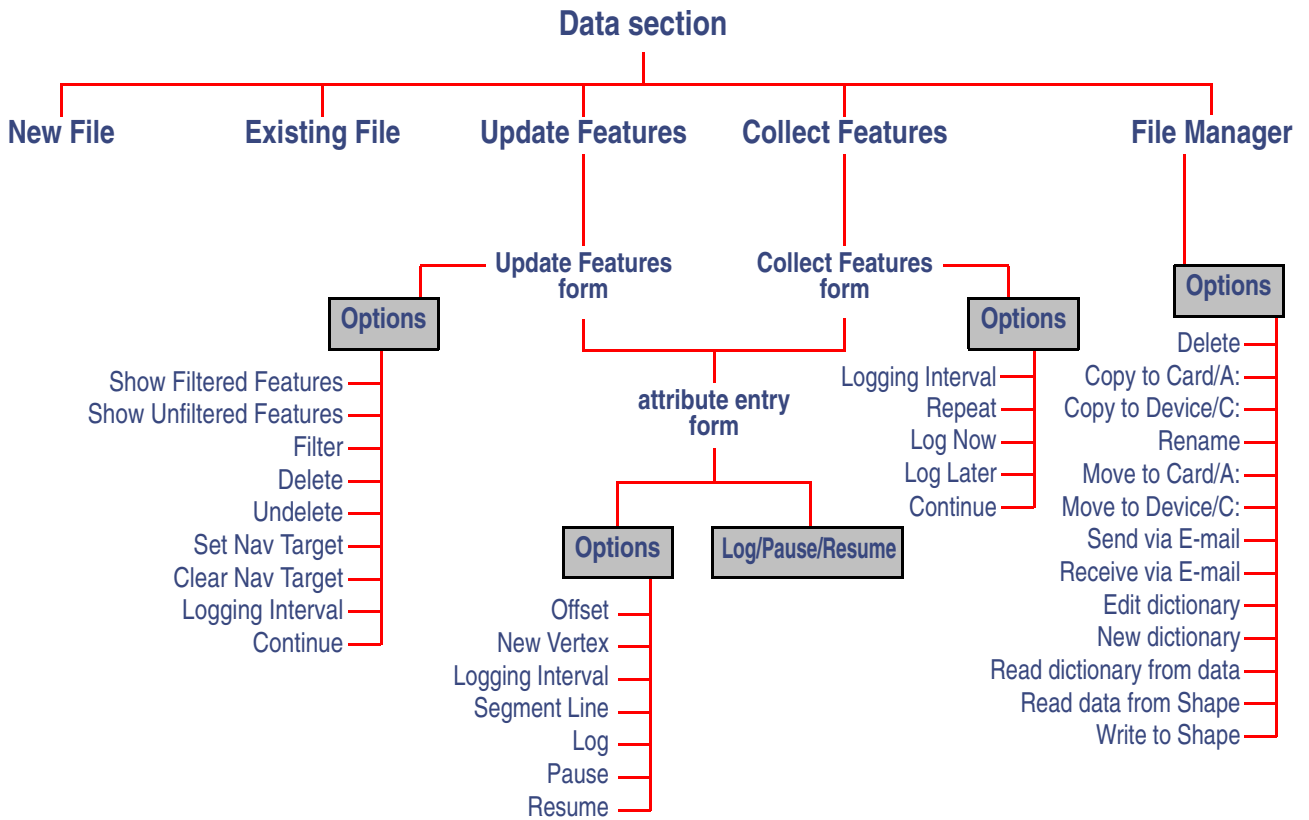

More...



Navigation section

Options

Navigation Options

Status section

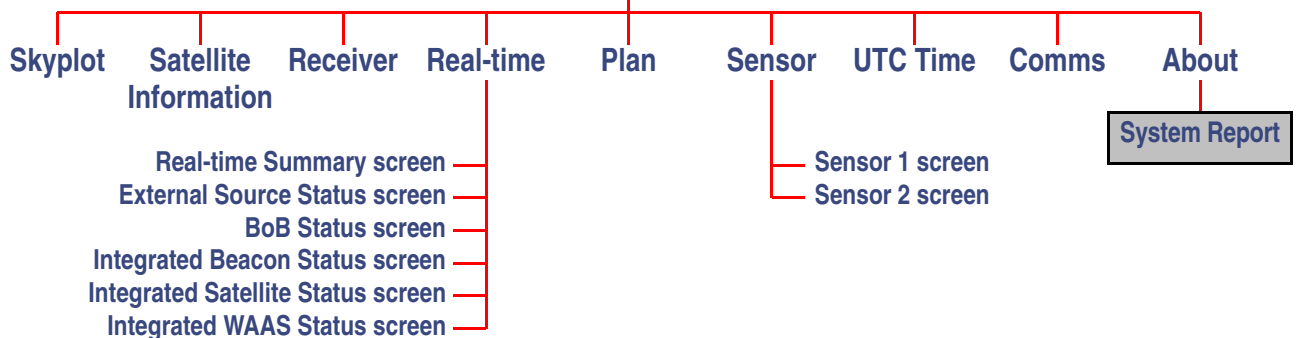

More...



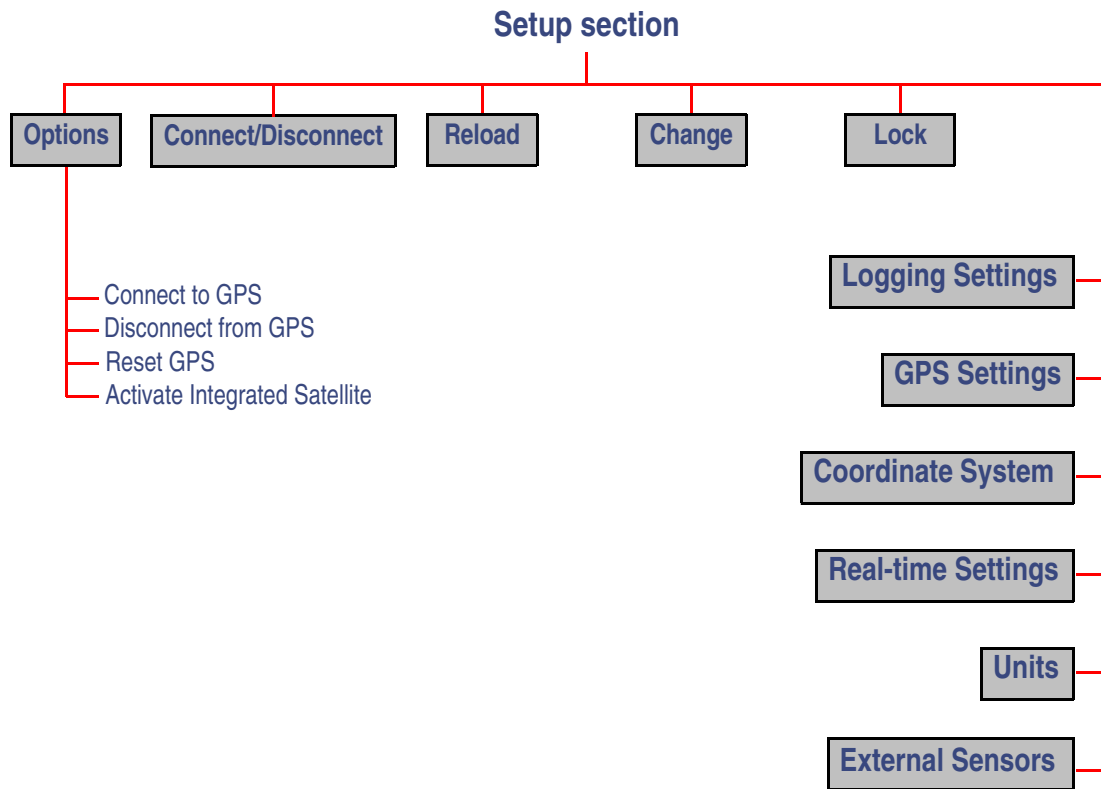

System requirements

The TerraSync software is designed for operation on either of the following:

- a CE device (an **H/PC Pro**, **H/PC 2000**, **palm-size PC**, or **Pocket PC** running the Windows CE operating system)
- a desktop or laptop PC running a Windows desktop operating system (for a full list of supported operating systems, refer to the [Trimble website](#))

Topics in this section are:

- **Windows CE**
- **Minimum specifications**



Windows CE

Microsoft Windows CE is an operating system developed for hardware that is physically small and has limited memory and power.

Windows CE is similar to the Windows desktop operating systems, but it is designed and optimized for running on small computers with a limited screen size. The TerraSync Operation Guide assumes you are reasonably familiar with the Windows CE operating system. For help on features of Windows CE that the TerraSync software uses, see [Windows CE operation](#).



Minimum specifications

The TerraSync software can be installed on a variety of CE devices, or on a PC such as a laptop computer.

The following CE devices are supported:

- **palm-size PC**
- **Pocket PC**
- **handheld PC (Professional)**
- **handheld PC 2000**

To run the TerraSync software on a CE device, you need **at least** the following:

- Windows CE version 2.11 or later
- A grayscale or color touch screen
- 320 × 240 (or 240 × 320) screen resolution
- One serial port for connection to a GPS receiver
- 16 MB RAM

[More...](#)



You can install TerraSync on any desktop or laptop PC that meets the minimum requirements. To run the TerraSync software on a PC, you need **at least** the following:

- A supported Windows desktop operating system installed (for a full list of supported operating systems, refer to the [Trimble website](#))
- One serial port for connection to a GPS receiver
- 16 MB RAM
- 10 MB free disk space

To transfer files between your desktop computer and the field computer, you must have one of the following installed on your desktop computer:

- the Trimble Data Transfer utility, which is available for free download from the [Trimble website](#)
- version 2.90 or later of the GPS Pathfinder Office software



You can connect a computer running the TerraSync software to the following GPS receivers:

- GPS Pathfinder Pro XL
- GPS Pathfinder Pro XR
- GPS Pathfinder Pro XRS
- GPS Pathfinder Pocket
- GPS Pathfinder Power
- GeoExplorer[®] CE series (combined GPS receivers and CE devices)

For information on connecting a receiver, refer to the TerraSync Release Notes.



TerraSync documentation

The following forms of documentation are available for the TerraSync software:

- [TerraSync Operation Guide](#)
- [Online help](#)



NOTE The online TerraSync Operation Guide and the printed documentation show the TerraSync software as it appears on a portrait orientation **Pocket PC** with a 240 x 320 resolution screen. On a larger screen, or in landscape orientation, some elements of the software are displayed differently. However, there is no functional difference between the two displays.

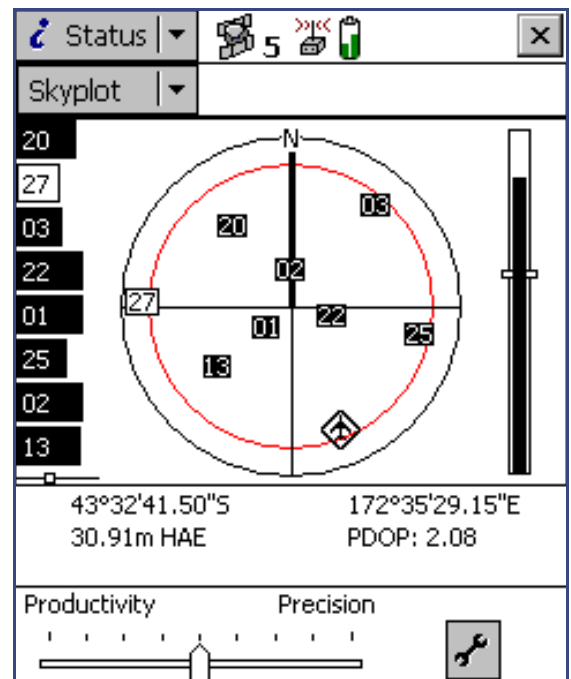
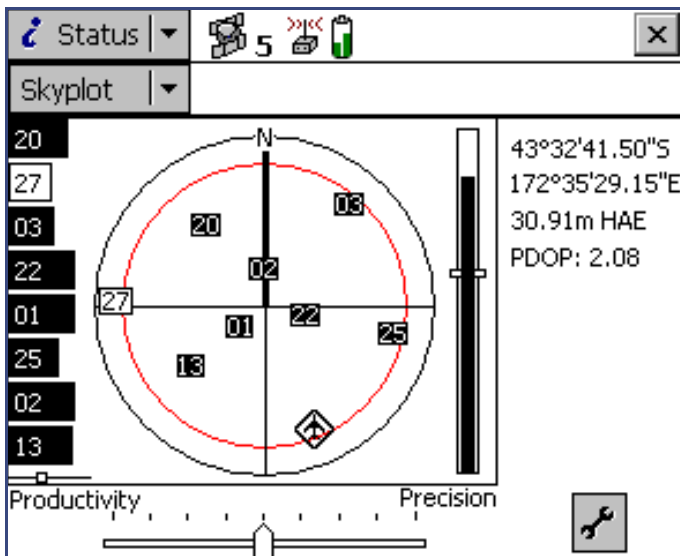

Above: Portrait orientation (240 x 320).

Left: Landscape orientation (320 x 240).



TerraSync Operation Guide

The TerraSync Operation Guide (this document) is the main source of documentation for the TerraSync software. It provides:

- installation instructions
- a tutorial on using the TerraSync software
- a complete reference to all screens and controls
- troubleshooting information
- a glossary of terms



The TerraSync Operation Guide is designed to be opened from the TerraSync CD-ROM and read on the screen.



Online help

You can access online help on your field computer for the TerraSync software. The TerraSync Help is a screen-by-screen reference that tells you what each control on the screen does.



Help is context-sensitive. If you access the Help while the TerraSync software is running, it opens at the topic that corresponds to the current TerraSync screen.

To access context-sensitive help from within the TerraSync software when using a PC, **H/PC Pro**, or **H/PC 2000**, tap . On a PC, you can also press **F1**. To access context-sensitive help when using a **palm-size PC** or **Pocket PC**, tap  and select Help.

If you tap  and select Help on an H/PC Pro, or on a P/PC when the TerraSync software is not running, the main Help Contents topic appears. Select TerraSync to open the Contents topic of the TerraSync Help.

Help Contents

- [Calculator](#)
- [Calendar](#)
- [Connections](#)
- [Contacts](#)
- [Inbox](#)
- [Microsoft Money](#)
- [Notes](#)
- [Pocket Excel](#)
- [Pocket Internet Explorer](#)
- [Pocket PC Basics](#)
- [Pocket Word](#)
- [Reader](#)
- [Settings](#)
- [Solitaire](#)
- [Tasks](#)
- [TerraSync](#)
- [Windows Media Player](#)

View   



INSTALLATION

The TerraSync software is installed on a CE device using a Microsoft ActiveSync connection, or directly onto a PC.

When you install TerraSync, or at any time after installation, you can use the **TerraSync Updater utility** to check the Trimble website for updated software, documentation, and language files.

These installation instructions cover:

- **Installing TerraSync on a CE device**
- **Installing TerraSync on a PC**
- **TerraSync Updater utility**



Installing TerraSync on a CE device

- **Equipment required for installation**
- **ActiveSync**
- **Installing on a CE device**
- **Installing translations on a CE device**



Equipment required for installation

To install the TerraSync software, you need the following:

- a CE device as specified in **Minimum specifications**
- a desktop computer with:
 - Windows 95, 98, Me, NT, 2000, or XP installed
 - a CD-ROM drive
 - Microsoft **ActiveSync** installed and an ActiveSync connection established between the desktop computer and the CE device
- one of the following connections between the desktop computer and the CE device:
 - serial cable
 - cradle
 - USB
 - infrared
 - modem
 - network card

For more information on connecting your CE device and desktop computer, refer to the documentation for your CE device.



ActiveSync

Microsoft ActiveSync is a program that lets you exchange information between your office computer and a **CE device**. You use ActiveSync whenever you:

- install software on the CE device
- move or copy files to or from the CE device
- **synchronize** data between your office computer and the CE device

NOTE Your CE device should be supplied with the ActiveSync software. If you do not have ActiveSync, or you want to use a translation of ActiveSync, you can download it from the **Microsoft website**.

TIP To ensure that all installation screens appear in the correct language, install the corresponding translation of the ActiveSync software.

Before you can exchange information you need to establish a connection between the two computers. The first time you connect your CE device to your desktop computer, ActiveSync prompts you to set up a **partnership** or **guest** relationship between the two computers.

Information about a partnership is stored permanently on the desktop computer, while a guest relationship lasts only as long as the two computers are connected. A partnership also lets you synchronize data between the two computers.

More...



NOTE To transfer data from your desktop computer to the TerraSync software, you can connect using **either** a partnership **or** a guest relationship. Trimble recommends that you use a guest relationship to connect to a TSCe field device or a GeoExplorer CE handheld, and an ActiveSync partnership for other CE devices.

TIP By default, some CE devices connect to the desktop computer at a **baud rate** of 19200 bits per second (bps). This may make installation and data transfer slow. For the fastest transfer rate, change the CE device connection settings to use the maximum baud rate available. For information on changing the connection speed, refer to the documentation for your CE device.

For information on creating partnerships or guest relationships, and connecting your desktop computer and CE device, refer to the ActiveSync Help.

For ActiveSync connection information that is specific to the TSCe field device and the GeoExplorer CE handheld, see **Connecting to ActiveSync**.



Installing on a CE device

Before beginning installation, ensure that you have enough free memory on the device. The TerraSync software requires at least 8 MB of free memory to install. If you are installing to a secondary internal storage location, such as the TSCe field device's storage card, TerraSync also requires at least 10 MB of free memory in that location. Most of this 10 MB is used only while installing and becomes available once installation is successfully completed.

WARNING The installation program cannot determine how much memory is available in the secondary storage location. You must ensure that 10 MB is free before you begin installation.

If memory is insufficient, this message appears during installation:

Click **Cancel**, remove any unwanted programs or data files from your CE device, and/or increase storage memory (see **Changing memory allocation**). Then start the installation again.



If memory space in the secondary internal storage location is insufficient, the installation may appear to complete successfully, but error messages may appear when you try to run the TerraSync software. If this happens, make more space available in the secondary storage location, then install the software again. If the problem persists, perform a **full** hard reset of the CE device. For information on performing a full hard reset, refer to the documentation for your CE device. Then reinstall the TerraSync software.

NOTE Trimble recommends that you remove any versions of the TerraSync software that are on your CE device before installing the latest version.

To install the TerraSync software:

1. Connect the CE device to the office computer. You can use any of the following methods:

- serial cable
- infrared
- cradle
- modem
- USB
- network card

For information on connecting your CE device to another computer, refer to the documentation for your CE device.

2. Make sure that the CE device and computer are switched on.

If an ActiveSync **partnership** for these two computers exists, ActiveSync starts and the office computer connects to the CE device automatically.



NOTE ActiveSync cannot connect to a CE device that is communicating with a GPS receiver on the same port. If you are upgrading or reinstalling the TerraSync software, make sure you disconnect from the GPS receiver and exit the software.

If there is no partnership, or the computers do not connect, you may need to install or set up **ActiveSync** on your office computer. For more information, refer to the documentation for your CE device.

When the two computers are connected, the Microsoft ActiveSync window appears and displays the message **Connected**:

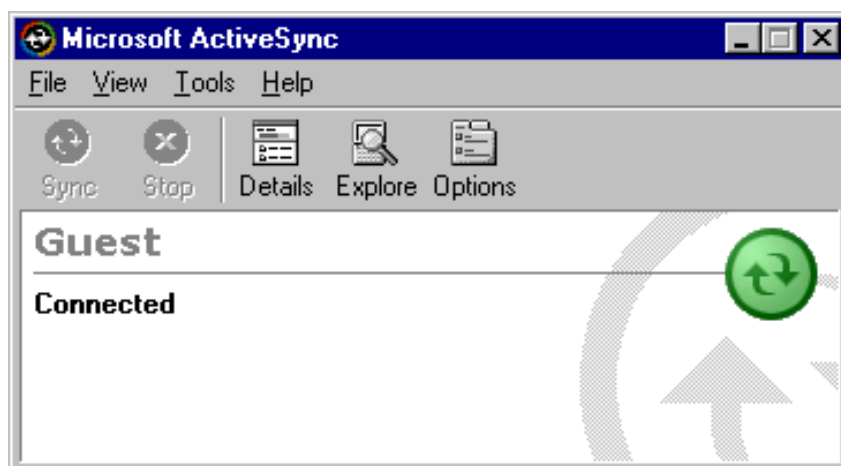

TIP If ActiveSync is installed, but the two computers do not connect, check that the CE device is set up to establish a PC connection. Open the Communications Properties dialog on your CE device. For information on how to do this, refer to the documentation for your CE device. Select the PC Connection tab and check that the Allow connection with desktop computer when device is attached check box is selected.

TIP Ensure that the CE device is configured to connect at the maximum **baud rate** available. For details on increasing the connection speed, see **ActiveSync**.

3. Make sure the TerraSync software is not running on the CE device.



4. Insert the TerraSync CD-ROM in the CD drive of your office computer. The Setup screen appears:



5. If this screen does not appear, select msetup.exe from your CD drive folder.



6. If required, select the Change Language option to change to the language you want to install TerraSync in. For more information, see [Installing translations on a CE device](#).
7. Select Installation. The following screen appears:

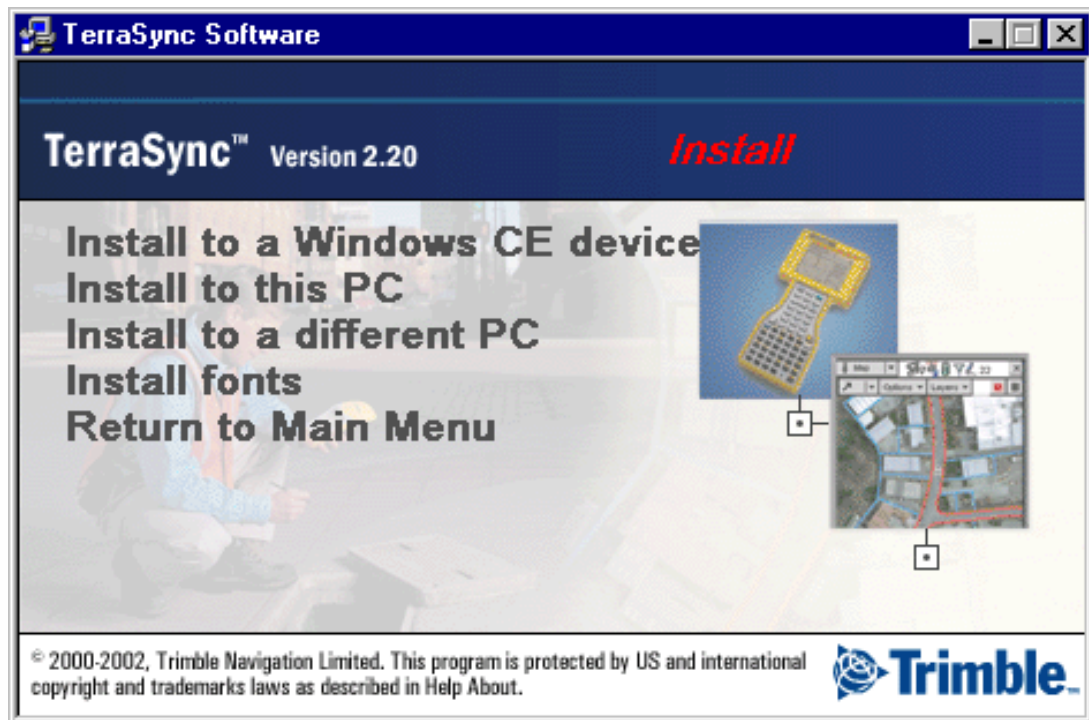

8. Select Install to a Windows CE device. The TerraSync installation wizard appears:



9. Follow the instructions on the screen to install the TerraSync software. You will need to enter your TerraSync version 2.20 serial number and authorization key (displayed on the CD case).
10. When the message **Install "Trimble TerraSync" using the default application install directory?** appears, do one of the following:
 - Click **Yes** to install the software to the default location. Use this option if you are installing onto:
 - a GeoExplorer CE handheld or a TSCe field device. TerraSync is always installed to the Disk on these CE devices.
 - a CE device that has no secondary storage, or only has **removable** secondary storage such as a CompactFlash card. TerraSync will be installed in RAM.
 - Click **No** to install the software to an internal secondary storage location. Use this option if you are installing onto:
 - a TDS Ranger
 - a Juniper Systems Allegro
 - any other CE device that has an **internal** secondary storage location

TIP Trimble recommends that you install to a secondary storage location to free up storage and program memory on the CE device.



More...

11. If you clicked **No**, the Select Destination Media dialog appears. From the Save In list, select Disk, then click **OK** to proceed with the installation.



More...

12. If the following message appears on the CE device during installation, tap **Yes To All** to continue:

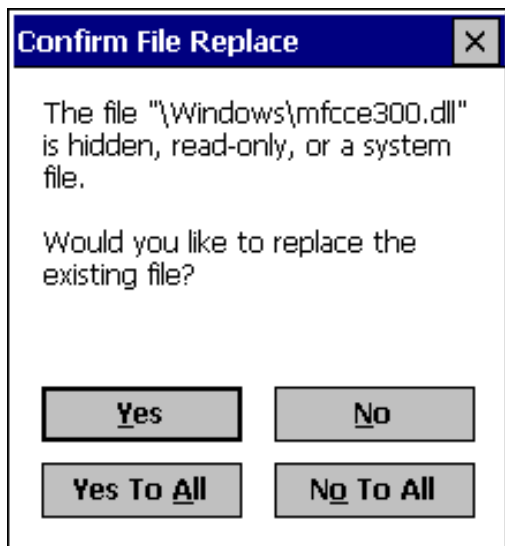

13. When the installation is complete, perform a soft reset on the CE device.
14. When you install TerraSync on a GeoExplorer CE handheld, some settings are stored in the main memory, even though TerraSync is always installed to the Disk. To avoid data loss, back up the main memory immediately after installing TerraSync.



To transfer files between your desktop computer and the CE device, you must have one of the following installed on your desktop computer:

- the Trimble Data Transfer utility, which is available for free download from the [Trimble website](#)
- version 2.90 or later of the GPS Pathfinder Office software

You must also have **ActiveSync** installed. Ensure that all necessary software is installed before using the TerraSync software.

NOTE You cannot use Data Transfer to transfer Shapefiles.



Installing translations on a CE device

The TerraSync software is available in several languages. You must install English TerraSync before you install a translation of the software. Language files for translated installations are not supplied on the CD-ROM, so the setup program uses the **TerraSync Updater utility** to automatically download the necessary files.

Trimble recommends that you only install a TerraSync translation on a CE device that has the corresponding language version of the operating system installed. For example, install Japanese TerraSync on a CE device with Japanese Windows CE installed. System commands (such as the **OK** and **Cancel** buttons) are generated by the operating system, so they appear in the language of the operating system on the CE device.



To install a translation of TerraSync onto a CE device:

1. Follow the procedure in **Installing on a CE device**. When the main Setup screen appears, select Change Language. The following screen appears:



2. Select the language that you want to install TerraSync in.



3. Continue with the installation.
4. At the end of the installation process, the TerraSync Updater utility starts automatically. Follow the instructions on the screen to download and install the language file for the selected language.



Installing TerraSync on a PC

- **Equipment required for installation**
- **Installing on a PC**
- **Installing on a different PC**
- **Installing translations on a PC**



Equipment required for installation

If the PC that you want to install the TerraSync software on has a CD-ROM drive, or has network access to a CD-ROM drive, you can install TerraSync directly onto the PC. Otherwise, you need to run the setup program on a desktop computer, transfer the necessary files to the PC, and then complete the installation on the PC.

To install the TerraSync software onto the **same** PC that you are running the setup program on, you need:

- a field computer: a PC as specified in **Minimum specifications** that has a CD-ROM drive, or has access to a CD-ROM drive over a network

To install the TerraSync software onto a **different** PC, you need:

- a field computer: a PC as specified in **Minimum specifications**
 - an office computer: a desktop computer with Windows 95, 98, Me, NT, 2000, or XP installed, and a CD-ROM drive
- a removable storage device with a capacity of at least 7 MB that can be connected to both computers (for example, a Zip drive or a CompactFlash card)

For more information on connecting your PC and desktop computer, refer to the documentation for your PC.



Installing on a PC

NOTE Trimble recommends that you remove any versions of the TerraSync software that are on your PC, including evaluation software, before installing the latest version. If you do not uninstall a previous version, you **must** install the TerraSync software to the same location.

TIP To install TerraSync on a PC that does not have access to a CD drive, follow the instructions in **Installing on a different PC**.

To install the TerraSync software:

1. Make sure the TerraSync software is not running on the computer.
2. Insert the TerraSync CD-ROM in the CD drive of the computer.



The Setup screen appears:



3. If this screen does not appear, select msetup.exe from your CD drive folder.



4. If required, select the Change Language option to change to the language you want to install TerraSync in. For more information, see [Installing translations on a PC](#).
5. Select Install. The following screen appears:

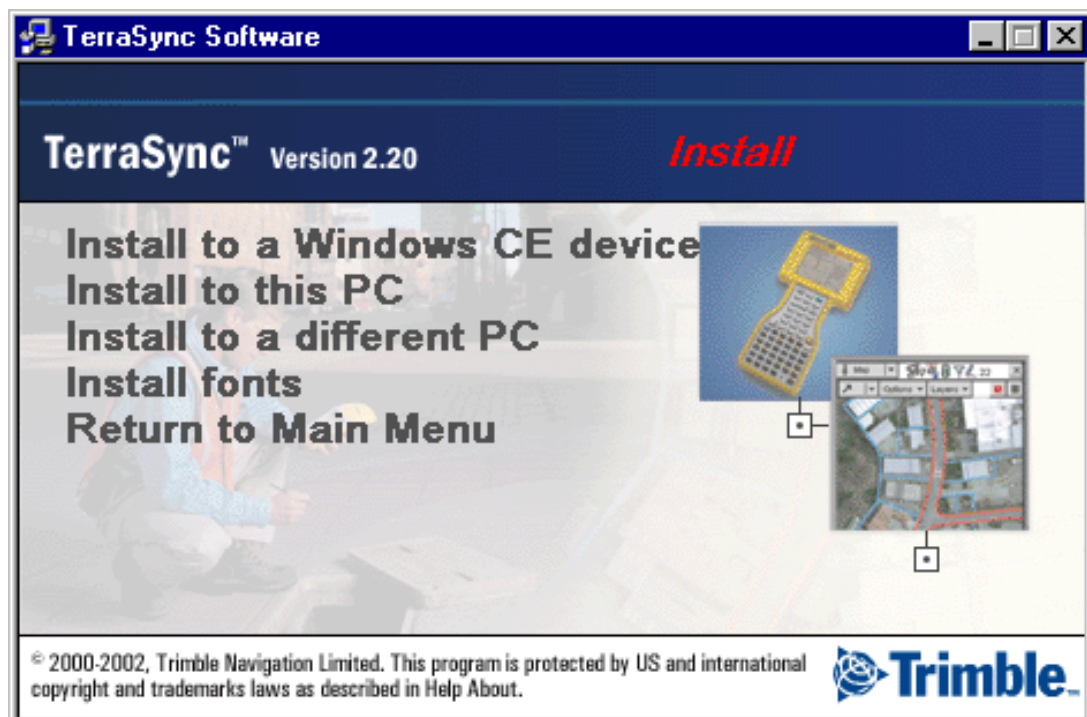

6. Select Install to this PC. The TerraSync installation wizard appears:



7. Follow the instructions on the screen to install the TerraSync software. You will need to enter your TerraSync version 2.20 serial number and authorization key (displayed on the CD case).

NOTE To transfer TerraSync files between a desktop computer and the PC that TerraSync is installed on, you must have one of the following installed on your desktop computer:

- the Trimble Data Transfer utility, which is available for free download from the [Trimble website](#)
- version 2.90 or later of the GPS Pathfinder Office software

NOTE You cannot use Data Transfer to transfer Shapefiles.

Ensure that all necessary software is installed before using the TerraSync software.



Installing on a different PC

If the PC that you want to install the TerraSync software on does not have access to a CD-ROM drive, either locally or across a network, you must use a removable storage device to transfer the necessary setup files from the TerraSync CD to the target PC, and then complete the installation on the PC.

To install the TerraSync software on a PC that does not have access to a CD-ROM drive:

1. Connect the removable storage device to the desktop computer.
2. Insert the TerraSync CD-ROM in the CD drive of the desktop computer.



3. Using Windows Explorer, locate the Install\PC folder on the CD and copy the PC folder to the storage device.
4. Disconnect the storage device from the desktop computer and connect it to the field computer.
5. Use Windows Explorer to copy the PC folder from the storage device to the field computer.
6. On the field computer, locate the PC folder and run setup.exe.
7. Follow the instructions on the screen to install the TerraSync software. You will need to enter your TerraSync version 2.20 serial number and authorization key (displayed on the CD case).

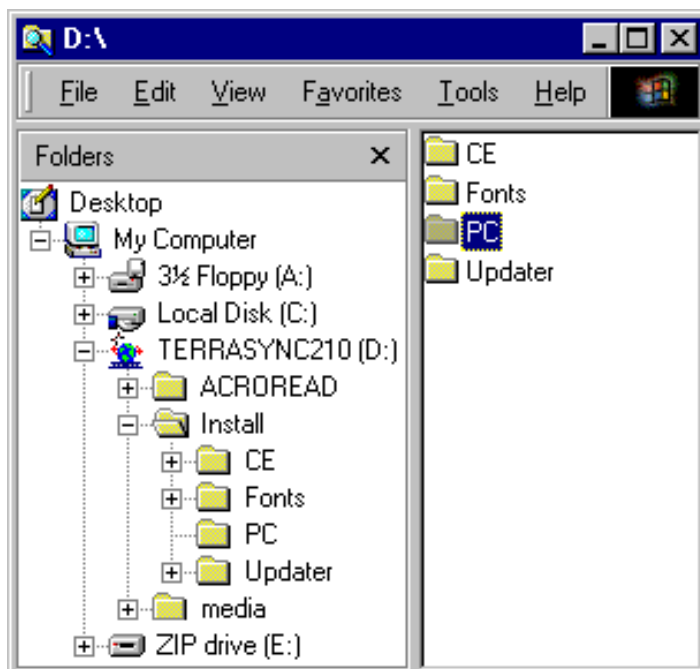

TIP

If you want to view the TerraSync Operation Guide, view the Release Notes, or use the **TerraSync Updater utility** in the field, copy all the files on the CD (except Install\CE and Install\Fonts, which are only used for Windows CE installations) to the field computer.



Installing translations on a PC

The TerraSync software is available in several languages. You must install English TerraSync before you install a translation of the software. Language files for translated installations are not supplied on the CD-ROM, so the setup program uses the **TerraSync Updater utility** to automatically download the necessary files.

Trimble recommends that you only install a TerraSync translation on a PC that has the corresponding language version of the Microsoft Windows operating system installed. For example, install Japanese TerraSync on a PC with Japanese Windows installed. System commands (such as the **OK** and **Cancel** buttons) are generated by the operating system, so they appear in the language of the operating system on the PC.

NOTE The fonts that TerraSync uses are included with translated Windows operating systems, so you do not need to install them on the PC.



To install a translation of TerraSync onto a PC:

1. Follow the procedure in **Installing on a PC**. When the main Setup screen appears, select Change Language. The following screen appears:



2. Select the language that you want to install TerraSync in, then continue with the installation.



TerraSync Updater utility

Use the TerraSync Updater utility to download the latest software updates, language files, and documentation from the Trimble website. Once you have downloaded files, you can install them immediately, or you can run the Updater utility later and select the downloaded files that you want to install. The files that you can download from the Trimble website depend on your TerraSync license.

To download or install files using the TerraSync Updater utility:

1. Run the Updater utility. Do one of the following:
 - When the TerraSync Updater screen appears during installation of the TerraSync software, select the Check for updates now option.
 - Insert the TerraSync CD-ROM in the CD drive of the computer where TerraSync is installed, or the computer that you used to install TerraSync to a CE device. The Setup screen appears. Select Download/Install Updates.
2. Follow the instructions on the screen to select the files to download and install. You will need to enter your TerraSync version 2.20 serial number and authorization key (displayed on the CD case).

For more information, refer to the TerraSync Updater utility Help.



TUTORIAL

This tutorial provides step-by-step instructions for some of the tasks that you will perform when using the TerraSync software.

The tutorial is divided into five parts: three relate to data collection, and two relate to real-time data update.

Data collection:

- **Preparing for data collection**
- **Data collection**
- **Processing the data**

Data update:

- **Preparing for data update**
- **Data update**

NOTE You cannot update imported data files using the **TerraSync Standard edition software**. If you have TerraSync Standard edition installed, you cannot perform the data update part of the tutorial.

More...



The tutorial helps you master the main concepts and tasks involved in using the TerraSync software. It is based on the following scenario:

The Seaview Authority maintains a GIS of its street signs, streets, and neighborhood parks for inventory purposes. Information needs to be collected about each entity, indicating its condition and other important information. You and your field crew are responsible for collecting new data and updating the existing GIS data for Starfish Bay.

- Data collection

In this part of the tutorial you collect new features. First, you create a GPS Pathfinder Office project and prepare your equipment for data collection. Then you go to Starfish Bay where you record new features and their attributes. When you return to the office, you postprocess the data you collected to achieve better positional accuracy for your results, and export the data to the Seaview Authority GIS.

- Data update

In this part of the tutorial you update existing GIS data. Some time has passed since you collected the features, so you need to go back and update their attributes. Before going back to Starfish Bay, you import data from the Seaview Authority GIS into the GPS Pathfinder Office software, transfer it to your field computer, and prepare for data update. Finally you return to the field and navigate to existing features to update their attributes. You use the TerraSync software and a **real-time differential GPS** source to navigate back to features and update their attributes.



Preparing for data collection

Before going to Starfish Bay to collect data, you need to create a new project in the GPS Pathfinder Office software. Then you need to check your equipment to make sure you are ready to go out into the field.

This section provides step-by-step instructions that will prepare you for data collection. The topics are:

- **Creating a project**
- **The Seaview data dictionary**
- **Checking the equipment**



Creating a project

The GPS Pathfinder Office software provides a set of tools for processing and managing GPS and GIS data. The GPS Pathfinder Office software lets you easily plan your data collection session and process the GPS data successfully.

Use the GPS Pathfinder Office software to organize work into projects. Dividing the work in this way helps you manage your files. You can give all projects meaningful names, and assign separate folders for base, export, and backup files. You can also set up projects for different groups of data. For example, you could create a project for each subdivision in the city, or for each month.

For this tutorial, you need to create a new project called TerraSync Tutorial.

To create a project in the GPS Pathfinder Office software:

1. Click  on the Windows taskbar, then select Programs / GPS Pathfinder Office.
A Trimble identification screen appears while the program is loading, followed by the GPS Pathfinder Office application window.
2. By default, the Select Project dialog appears. If it does not appear, from the File menu select Projects.



3. Click **New**. The Project Folders dialog appears:

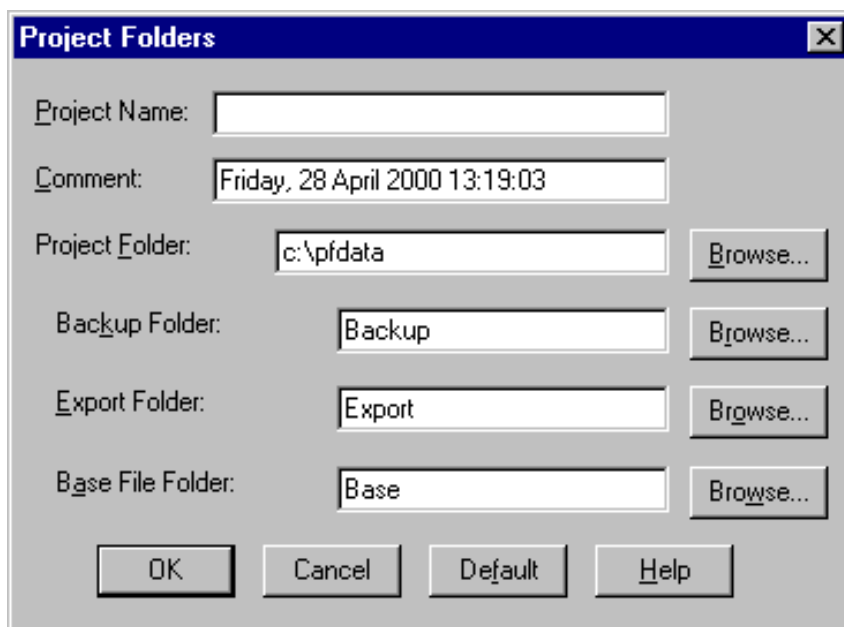

4. In the Project Name field, enter **TerraSync Tutorial**, and click **OK**.
The Project Folder field updates to show the default folder for the new project.
5. Click **OK** again to close this dialog and create the new project.



6. In the Select Project dialog, TerraSync Tutorial is selected in the Project Name field. Click **OK** to open the new project.

For more information, refer to the GPS Pathfinder Office Help.



The Seaview data dictionary

A data dictionary contains a description of the features and attributes relevant to a particular project or job. It is used in the field to control the collection of a **feature** and its **attributes**.

The signs, roads, and parks in Starfish Bay that you need to map are **features**. The different types of information that you record for each type of feature are **attributes**. For example, the condition of a sign, or the name of a park, would be an attribute.

To ensure that the data you collect in the field is in the correct format for the Seaview Authority GIS, you need to use a data dictionary that contains the same features and attributes as the Seaview Authority GIS. The Seaview.ddf data dictionary has already been created for this purpose. When you installed the TerraSync software on your field computer, this file was automatically installed.



Checking the equipment

Before going out into the field with the TerraSync software and your Trimble GPS receiver, you should check that you have all the necessary GPS hardware, batteries, and cables.

The TerraSync Release Notes provide cabling diagrams for the Trimble GPS receivers the TerraSync software can connect to.

Trimble recommends that before you leave the office you:

- set up your entire GIS/GPS data collection system and test it to make sure that everything is connected correctly
- make sure your receiver and field computer batteries are charged
- make sure your field computer and GPS receiver are communicating correctly.

WARNING After testing the system, remember to turn off the field computer and any other equipment (such as radios) before proceeding to the start point of your field work. Leaving equipment on wastes battery life, especially if it will be some time before you need to use the equipment.

TIP When you turn the field computer off, any receiver that is connected to it is automatically turned off.



Data collection

This part of the tutorial uses the Seaview data dictionary that is already installed on your field computer. You are ready to go to Starfish Bay and collect features. But first there are some tasks that you should complete. This section explains these tasks and gives the step-by-step instructions required to collect point, line, and area features, with a variety of different attributes. The topics are:

- **Initial tasks**
- **Collecting new data**

NOTE To complete this part of the tutorial, you need to be outside, in a location where you can get good GPS signals. Your TerraSync display will appear different to the screens shown in some places in this tutorial.



Initial tasks

Before starting a data collection session, you need to perform the following tasks:

- **Starting the TerraSync software**
- **Getting a clear view of the sky**
- **Checking the GPS status**
- **Configuring the GPS slider bar**



Starting the TerraSync software

When you get outside, switch your field computer on and start the TerraSync software. The GPS receiver should start automatically when you start TerraSync.

On the taskbar, tap  and then select Programs / TerraSync. While the software is loading, a Trimble identification screen appears:

The **Skyplot** subsection of the Status section always appears after the identification screen is displayed.



Getting a clear view of the sky

Move to a location where you have a clear view of the sky.

Signals can be received from any direction. Satellite signals can be blocked by people, buildings, heavy tree cover, large vehicles, or powerful transmitters. Anything that blocks light also blocks signals. GPS signals can go through leaves, plastic, and glass, but these all weaken the signal.



Checking the GPS status

When you start the TerraSync software, it automatically connects to the GPS receiver, and begins to track visible satellites and to calculate its current position. Use the satellite icon on the **Status bar** to check whether the receiver is computing GPS positions. It provides information about the geometry of the satellites that are being used to compute GPS positions.

Use the Status section to view the satellites currently tracked and those that are being used to calculate the current position.

NOTE For further explanation of satellite geometry and how this can affect your GPS data collection, refer to the Mapping Systems General Reference.



To view the GPS status:

1. The Skyplot appears when you first run the TerraSync software. If this screen is not visible, tap the Section list button and select Status, then tap the Subsection list button and select Skyplot.

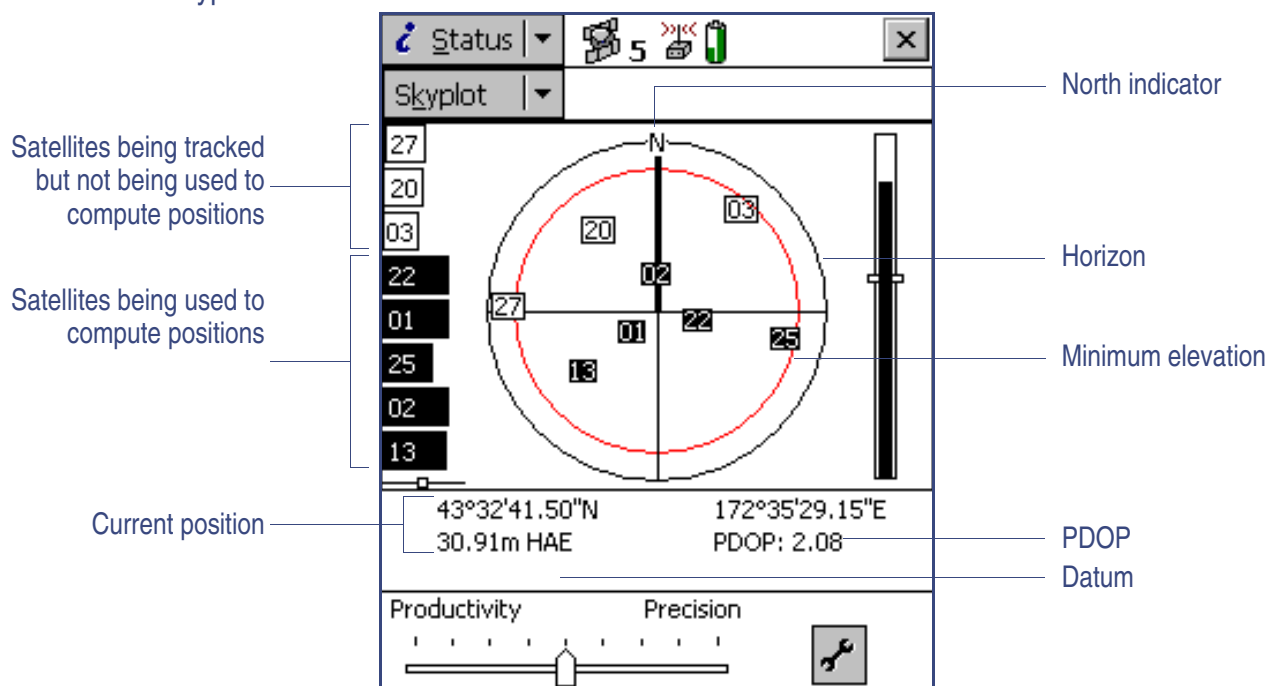

2. Use the skyplot to check the satellites that are being tracked and to see your current position.

More...



Black boxes represent satellites that the receiver is using to compute its current GPS position. Unfilled boxes represent satellites that the receiver is getting signals from but is not using because the signals are too weak. In the above example, eight satellites are being tracked and five of these satellites are being used to compute GPS positions.

NOTE Numbers with no box represent satellites that are available, but that the TerraSync software is not receiving signals from.

Your current GPS position is displayed at the bottom of the screen.

TIP For detailed information on satellite positions and signal strengths, use the **Satellite information** subsection of the Status section.

You need a minimum of four satellites, with good geometry, to compute a 3D GPS position. When you turn on the receiver, it automatically starts to track visible satellites and to calculate its current position. Use the satellite icon in the **Status bar** to check whether the receiver is computing satellite positions. If the satellite icon and the number below it are solid (not flashing), the receiver is computing GPS positions.

If the satellite geometry is poor or there are too few satellites available to compute GPS positions, adjust the **GPS slider** or wait until conditions are more favorable.



Configuring the GPS slider bar

There are some critical settings in the TerraSync software that you should configure before collecting data (for example, the GPS settings). Configure these before leaving the office, or in the field. You can also set other (non-critical) settings to suit your application or preferences.

The following steps show you how to configure the GPS slider bar to best suit the environment of Starfish Bay.

Starfish Bay is an open area, with few tall buildings, trees, or other obstructions. Therefore, you need to adjust the GPS slider bar to allow better positions to be recorded. You will record fewer positions because you will restrict logging to locations when there is good satellite geometry, but the positions you record will have higher quality.

NOTE By default, the GPS slider bar is set at the middle setting. When you adjust the GPS slider bar to the left, you can obtain positions in less favorable conditions that are less precise.



To configure the GPS slider bar:

1. Tap the Section list button and select Setup.
2. Tap **GPS Settings**. The GPS Settings form appears:

TIP Use a high setting on the GPS slider bar whenever a project requires the highest level of precision.

3. Drag the slider control to the right to raise the GPS slider bar two positions.

This lets you collect fewer positions, but they will be more precise. Because there are few obstacles to block your view of the sky, this may provide better overall results. If the slider bar is set too high, the precision of the positions collected is high, but there may be places in the Starfish Bay area that cannot be mapped.

4. Tap **OK** to close the GPS Settings form.

For more information, see [GPS Settings](#).

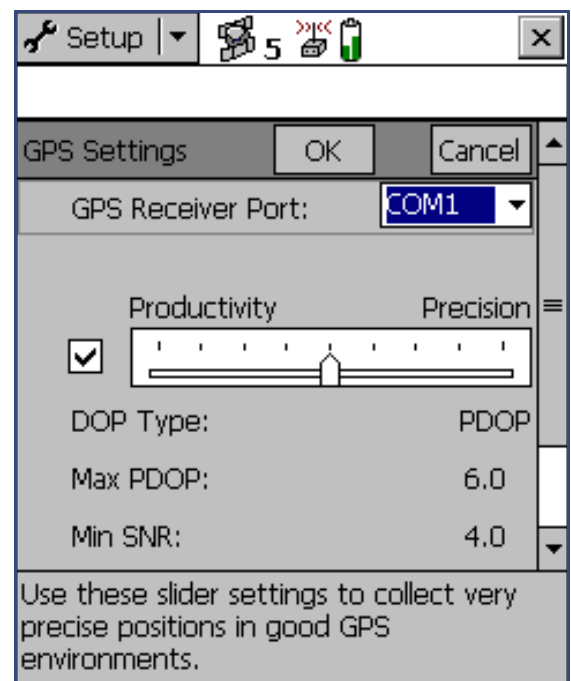

Collecting new data

Your supervisor has sent you to Starfish Bay to map new road signs, roads, and parks. This part of the tutorial gives step-by-step instructions for the following tasks:

- **Creating a new data file**
- **Collecting a point feature**
- **Collecting a line feature with Log Later**
- **Collecting an area feature**
- **Ending the data collection session**



Creating a new data file

Before starting the data collection session, you need to create a new data file to store the new features and attributes you collect. Use **The Data section** to do this.

To create a new file:

1. Tap the Section list button, then select Data.
2. Tap the Subsection list button, then select New File. The New File screen appears:
3. The TerraSync software automatically enters a default name in the File Name field. Replace the default name with **Starfish**.
4. In the Dictionary Name field, make sure the Seaview data dictionary is selected.

The screenshot shows the 'Create New Data File' dialog box. At the top, there is a 'Data' dropdown menu and a 'New' dropdown menu. To the right of the 'New' dropdown is a 'Create' button. Below the dropdowns, the text 'Create New Data File:' is displayed. There are two input fields: 'File Name:' with the value 'R121416A' and 'Dictionary Name:' with the value 'Seaview'.



5. Tap **Create**. The Collect Features screen appears:

This screen shows a list of all the features in the data dictionary.

You have created a new data file, so you can now start collecting features.

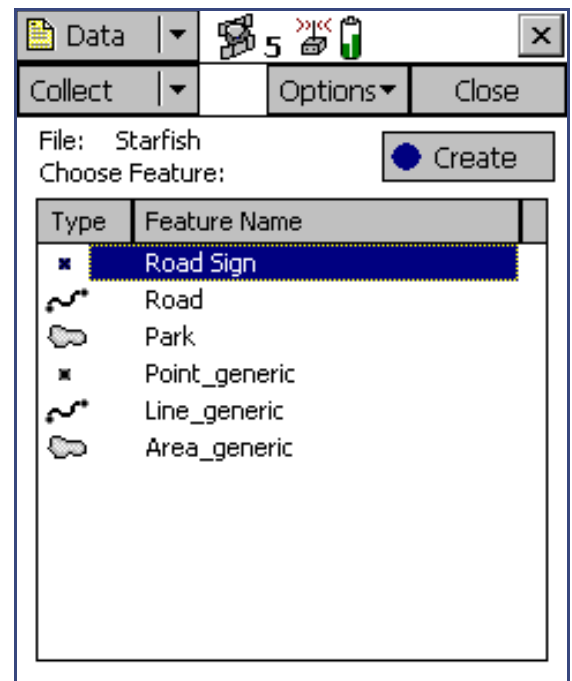

Collecting a point feature

The first new feature you need to record is a road sign. This is a point feature.

When you record a point feature, you remain stationary for some time. The TerraSync software logs a number of GPS positions during this time. These positions are averaged together to compute the final GPS position of the point feature.

When the TerraSync software is logging GPS positions, the logging icon  appears in the status bar. The number beside the icon indicates how many positions have been logged for the selected feature.



To record a point feature:

1. Make sure the Collect Features screen is open. If it is not, tap the Section list button and select Data, then tap the Subsection list button and select Collect Features.
2. In the Choose Feature list highlight Road Sign, then tap **Create**. The attribute entry form for the Road Sign feature type appears:

The Date Visited attribute has been set up to auto-generate on creation, so it is automatically filled in with today's date. You do not need to enter a value in this field.

3. In the Type field, select Stop from the list of options. These options are the values defined in the data dictionary.

This is a new sign, so its condition is good.

Good is selected by default in the Condition field, so you do not need to change this field.

You have now recorded all the attribute information needed for the road sign.

The screenshot shows the TerraSync mobile application interface. At the top, there is a status bar with icons for Data, a signal strength indicator (5), a battery level indicator, and a close button (X). Below the status bar, there is a navigation bar with a 'Collect' dropdown menu, an 'Options' dropdown menu, and a 'Pause' button with a double vertical bar icon. The main content area displays the attribute entry form for a 'Road Sign' feature. The form has a title bar with '1 Road Sign', 'OK', and 'Cancel' buttons. Below the title bar, there are three fields: 'Date Visited:' with a date picker set to '12/14/00', 'Type:' with a dropdown menu, and 'Condition:' with a dropdown menu set to 'Good'.



4. As the software logs GPS positions, the counter beside the logging icon increments. When you have finished entering the attributes, tap **OK** to close the road sign feature. The attribute entry form closes and you are returned to the Collect Features screen.
5. Later in the tutorial, you will navigate back to a sign that needs to be replaced, and update its attributes. You need to collect this road sign feature now. Repeat the above procedure to log another road sign feature. When you get to step 4, change the Condition field to Replace.



Collecting a line feature with Log Later

The next feature you need to record is a road. This is a line feature. To record a line feature, you need to travel along the line. As you do so, the TerraSync software will record a GPS position at the configured logging interval, which defaults to the value that was set when the feature was created in the data dictionary. These positions are joined together to form a line.

By default, the TerraSync software begins logging GPS positions as soon as you open a new feature. You can use the Log Later option to delay logging of positions until you have entered the attributes for the feature, or until you reach the start of the feature.

To record a line feature with the Log Later option:

1. Make sure the Collect Features screen is open. If it is not, tap the Section list button and select Data, then tap the Subsection list button and select Collect Features.
2. In the Choose Feature list, highlight Road.
3. Tap **Options** and select Log Later.
4. Tap **Create**. The Road attribute entry form appears.

You can record the attributes of the road before logging GPS positions.

NOTE When you use the Log Later option, the pause icon **||** flashes in the status bar to let you know that the TerraSync software is not logging GPS positions.



More...

5. The Name field is already highlighted, so enter the name of the road, **Seagull St**.
6. Seagull Street has two traffic lanes. In the Number of Lanes field, enter the value **2**.
7. Move to the start of the road and tap **Log** to begin logging GPS positions for the road feature. The pause icon disappears from the status bar and the number on the logging icon increments as each position is recorded:
8. Continue down the road. When you reach the end of the line you are logging, tap **OK** to close the road feature.

NOTE The Log Now and Log Later functions apply to all features you collect.

The screenshot shows the '3 Road' form in the TerraSync software. The form has a title bar with 'Data', 'Collect', 'Options', and 'Pause' icons. Below the title bar, there are 'OK' and 'Cancel' buttons. The 'Name' field is highlighted and contains the text 'Seagull St'. The 'Number of Lanes' field contains the value '2'. The status bar at the top of the screen shows 'Data', 'Collect', 'Options', and 'Pause' icons.



Collecting an area feature

Now you need to record the park in Starfish Bay. This is an area feature.

To record an area feature, you need to travel around the perimeter of the area. As you do so, the TerraSync software will log GPS positions at the logging interval set in the data dictionary. These positions are joined together to form the perimeter of the area.

The first and last GPS positions are joined together to close the area, so there is no need to return to the exact start point.

When you logged the road feature, you recorded the attributes first, then started logging GPS positions. For the park feature, you will log GPS positions at the same time as you record the attributes.

To collect an area feature:

1. Make sure the Collect Features screen is open. If it is not, tap the Section list button and select Data, then tap the Subsection list button and select Collect Features.
2. Tap **Options** and select Log Now.
3. In the Choose Feature list, highlight Park.
4. Tap **Create**.



The attribute entry form for the Park feature opens, and the TerraSync software starts to log positions:

You can pause logging at any time. For example, if you are driving around the perimeter of the park and you want to stop and examine a sign some distance from the park, you would stop logging positions for the park boundary. You can also pause logging if you want some time to enter attribute values.

5. To pause logging, tap **Pause**. The TerraSync software stops logging positions and a pause icon flashes in the status bar. To continue collecting the park feature, tap **Resume** to resume logging. The pause icon disappears.

For more information, see [Pausing and resuming logging](#).

Data	5	>><<	4	X
Collect		Options	Pause	
4 Park		OK	Cancel	
Name:				
<input type="text"/>				
Restrooms?:				Yes



- You can view the map while collecting features. To do this, tap the Section list button and select Map. The features that you have collected are displayed on the map, along with the park perimeter that you are currently collecting.

You can view the map at different scales. To do this, tap the Zoom In or Zoom Out button on the **Command bar**.

Alternatively, tap the Map Tools list button, select Zoom In or Zoom Out, and select the point on the map that you want to zoom in or out from.

Current (area) feature
Line feature
Point feature

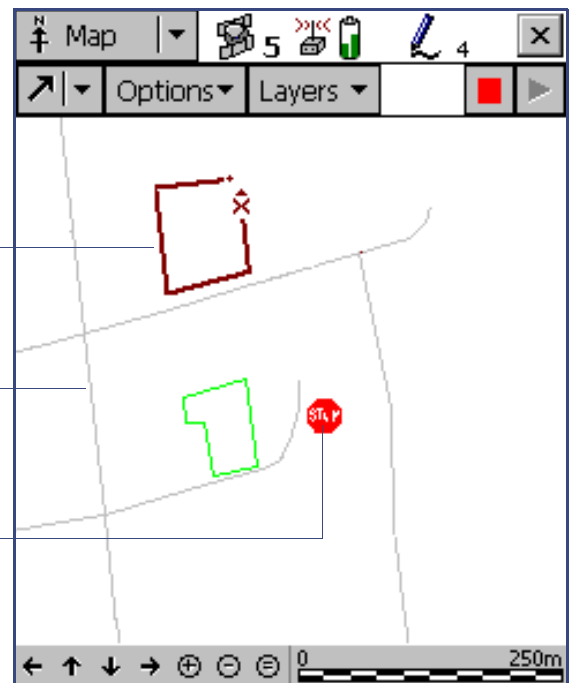

NOTE Your Map screen may appear different from the one shown.

- Tap the Section list button and select Data to go back to the Data section. The Park attribute entry form is still active and the TerraSync software is still logging positions for the park.

More...



- Enter the park's attributes. In the Name field, enter **Starfish Park**, and from the Restrooms? field select Yes.
- When you have walked around the perimeter of the area, tap **OK** to close the feature.

TIP There are several advanced data collecting techniques that make a data collection session more efficient. For more information, see **Advanced data collection**.



Ending the data collection session

When the data collection session is complete, close the data file and exit the TerraSync software.

To close the open data file and exit the TerraSync software:

1. Tap **Close** in the Collect Features screen.

A message appears, asking you to confirm that you want to close the open file.

2. Tap **Yes** to close the current data file and return to the New File screen.

3. Tap the  button in the top right corner of the screen.

A message appears, asking you to confirm that you want to exit the TerraSync software.

4. Tap **Yes** to exit the TerraSync software.



Processing the data

After your data collection session, use the GPS Pathfinder Office software to process the data collected and transfer it to the GIS.

This part of the tutorial shows you how to transfer and view the data. The topics are:

- **Transferring data**
- **Differentially correcting data**
- **Viewing data**
- **Exporting data to a GIS**



Transferring data

You need to transfer the data you collected in the field from the field computer to the office computer.

To transfer the Starfish Bay data file from your field computer to the office computer:

1. Switch on your field computer and your office computer and connect the two computers.
 - If your field computer is a CE device, the ActiveSync software should automatically establish a connection with the CE device. When ActiveSync is connected to a CE device, the message **Connected** appears in the main ActiveSync window, and its taskbar icon is green.

If ActiveSync does not connect automatically, connect to the CE device manually. For information, refer to the ActiveSync help, or see [Troubleshooting](#).
 - If your field computer is a PC, make sure there is a network connection between the PC and office computer.
 - If the TerraSync software and the GPS Pathfinder Office software are installed on the same computer, you only need to switch the computer on.
2. In the GPS Pathfinder Office software, select Utilities / Data Transfer.

The Data Transfer dialog appears.



3. From the Device list, select the appropriate device (GIS Datalogger on Windows CE or GIS Datalogger on Windows PC). Alternatively, if you have set up a device definition for your field computer, select that device name from the list.

The Data Transfer utility automatically connects to the field computer.

4. Select the Receive tab.
5. Click **Add** and select Data File from the drop-down list. The Open dialog appears.

NOTE The files that appear are the files in the TerraSync data folder on the field computer.

6. The Starfish file appears in the list of files. Highlight this file.



7. Check that the Destination field shows c:\PfdData\TerraSync Tutorial, then click **Open**. The Open dialog disappears and the Starfish file appears in the Files to Receive list:

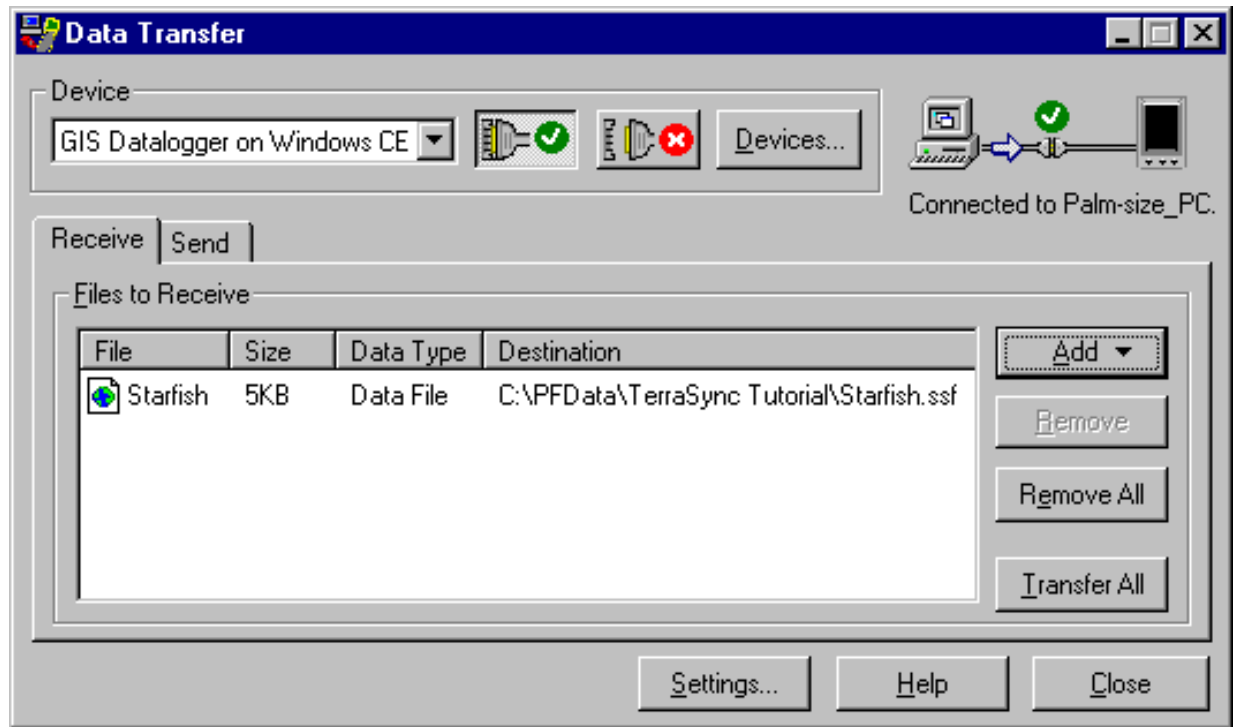

8. Click **Transfer All**. The data file is transferred to the desktop computer.



9. A message box showing summary information about the transfer appears. Click **Close** to close it.
 10. Click **Close** to close the Data Transfer utility.
- For more information, refer to the GPS Pathfinder Office Help.



Differentially correcting data

The data collected by GPS receivers is subject to errors, including small satellite clock errors, orbit errors, atmospheric noise, and multipath errors. The vast majority of these errors can be removed from the data by **differential correction**. Differential correction improves the accuracy of GPS positions to the specified accuracy of the receiver.

To differentially correct the data file:

1. Start the GPS Pathfinder Office software and open the TerraSync Tutorial project.
2. Select Utilities / Differential Correction to start the Differential Correction utility.



The following dialog appears:

3. The file you transferred from the CE device should appear in the Selected Files field. If it does not, click **Browse** and locate the file Starfish.ssf, then click **Open**.

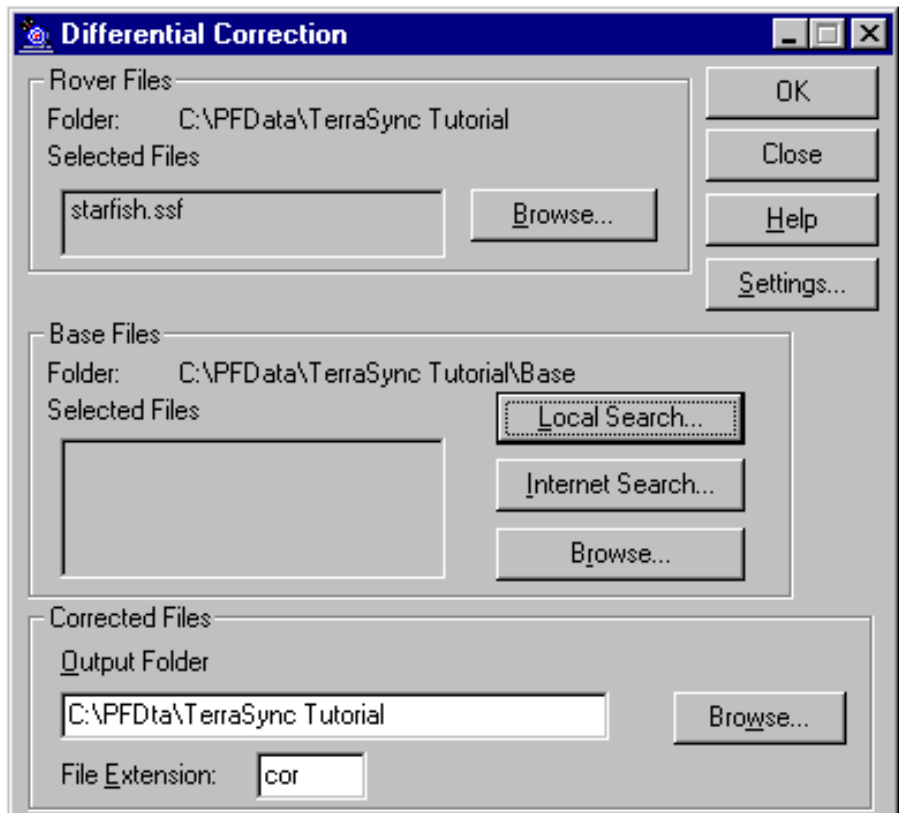

- Specify the location of your base files. Depending on the source of base files, there are three options available: Local Search for base files, Internet Search for base files, or Browse. By default, base files are stored in the current project's base file folder on your local drive. If you need to change the Folder path for the Local Search for base files option, click **Browse**. The Confirm Selected Base Files dialog appears:

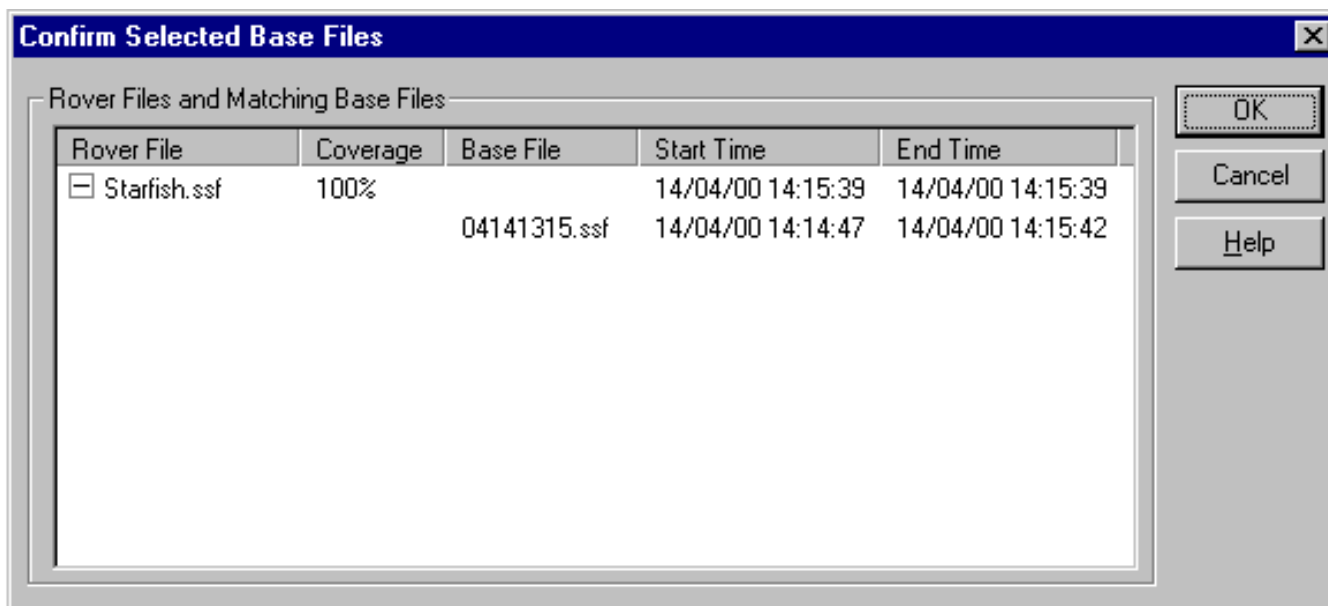

More...



- Use the Confirm Selected Base Files dialog to make sure the selected base files provide coverage for the rover files. Click **OK**. The Reference Position dialog appears:

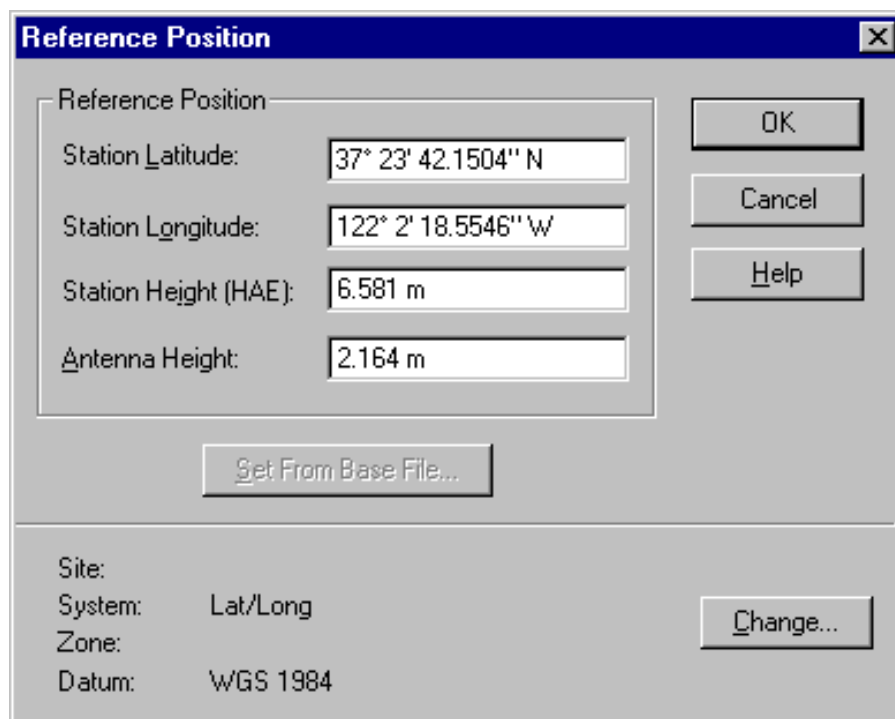

- Click **OK** to confirm the reference position.

More...



7. Specify the output folder. By default, the output folder is the current project folder.
8. Select a processing option:

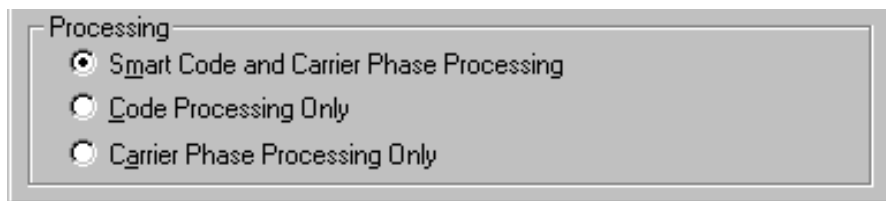

By default, Smart Code and Carrier Phase Processing is selected.

9. Click **OK** to differentially correct the selected files.
10. The Differential Correction Completed dialog details the results of the differential correction. Click **Close** to close this dialog.

For more information about differentially correcting data, refer to the GPS Pathfinder Office Help.



Viewing data

When the data has been transferred and differentially corrected you can display, edit, and plot it using the GPS Pathfinder Office software. The GPS Pathfinder Office Map window is the best way to view field data. Use it to make graphical queries and measurements on the collected data. You can specify the colors, symbols, and line styles for each feature. The Map window provides an easy way to verify the integrity of the field data.

To view the data:

1. In the GPS Pathfinder Office software, select File / Open. Select the Starfish.cor file. The current project folder is the default path (C:\Pfddata\TerraSync Tutorial).
Starfish.cor is the differentially corrected version of the file Starfish.ssf, which you transferred from your field computer.
2. If the Map window is not visible, select View / Map to display it.



The Map window displays the selected file:

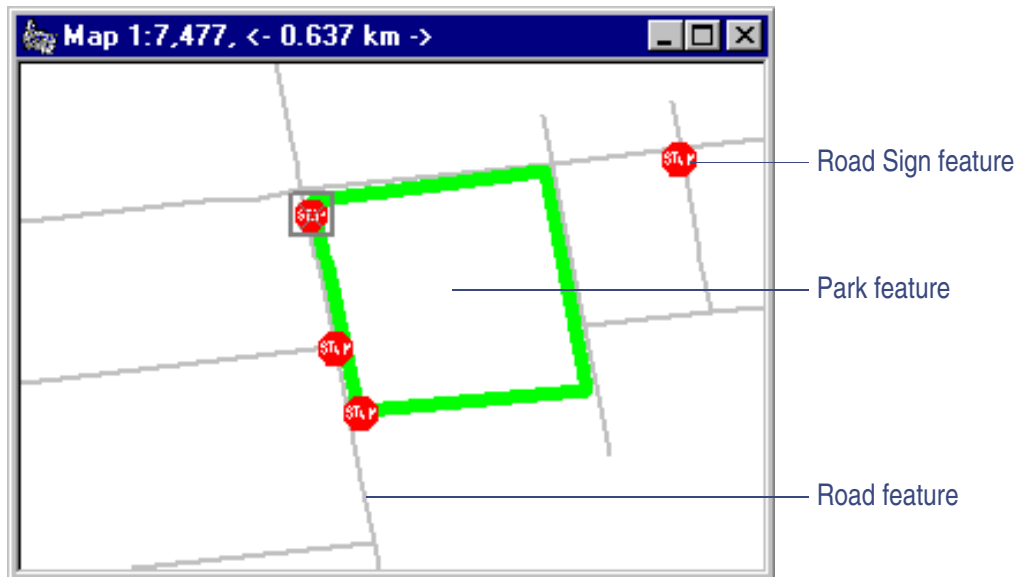

NOTE Your Map window may appear different from the one shown.

3. To display the attributes of any feature on the map, double-click the feature. The Feature Properties dialog appears. It provides attribute information about the selected feature.



4. Change the color of the Park feature. Right-click the Park feature on the map. From the shortcut menu select Park Layer Style. The Park style dialog appears:
5. Use this dialog to change the color of the park area to green.

For more information about the GPS Pathfinder Office Map window display, refer to the View menu topic in the GPS Pathfinder Office Help.

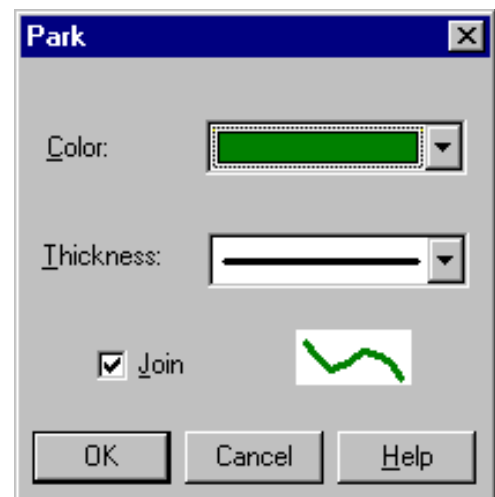

Exporting data to a GIS

The Trimble Export utility in the GPS Pathfinder Office software converts files in **SSF file** format into a format that can be read by a GIS, CAD, or database system. It lets you export point, line, and area features, their attributes, and positions to a variety of other formats.



To export data to a GIS:

1. In the GPS Pathfinder Office software, start the Export utility by selecting Utilities / Export:
2. The file Starfish.cor should be displayed in the Selected Files field. If it is not, click **Browse** to display the Open dialog. Browse for Starfish.cor, highlight it, and click **Open**.
3. Select the output folder. By default, this is the export folder in the current project.

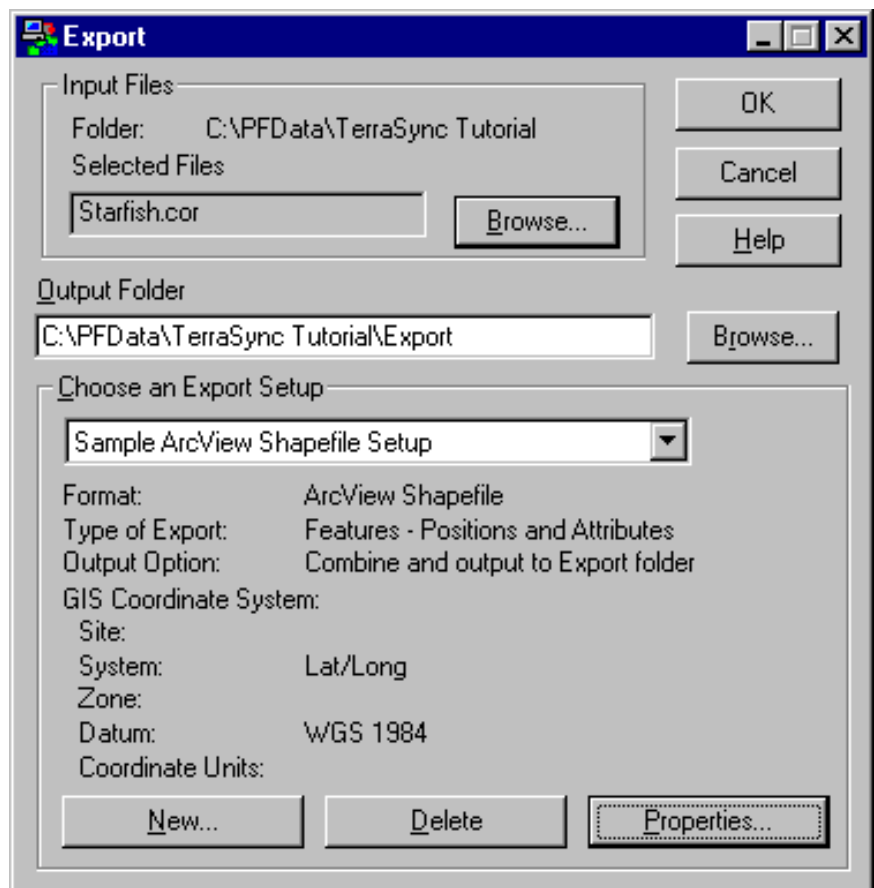

4. In the Choose an Export Setup group, select Sample ArcView Shapefile Setup.
5. Make sure the GIS Coordinate System group shows the Latitude/Longitude coordinate system. If it is incorrect, click **Properties**, then select the Coordinate System tab in the Export Properties dialog to change the coordinate system. Click **OK** when you have finished.
6. Click **OK** to export the selected file(s) using the specified export setup.
7. The Export Completed dialog details the results of the export. Click **Close** to close this dialog.
8. The file is now in the format required by your GIS. You can now open it in your GIS.

NOTE The Batch Processor utility increases productivity by letting you automate repetitive tasks that you do when you return to the office, such as data transfer, differential correction, and export to your GIS. When you come back from the field, simply connect your field computer to the office computer. The Connection Manager utility automatically recognizes that a field computer is connected and runs the Batch Processor utility.

For more information about these utilities, refer to the GPS Pathfinder Office Help.



Preparing for data update

NOTE You cannot update imported data files using the **TerraSync Standard edition software**. If you have TerraSync Standard edition installed, you cannot perform the data update part of the tutorial.

A year has passed and it is necessary to return to Starfish Bay to check the condition of the road signs. A different field crew is going to do this. The TerraSync software and a real-time source will be used to navigate to each sign, and the Seaview data dictionary will be used to verify and update the attributes for those features.

This part of the tutorial gives step-by-step instructions that should be performed when preparing to take a field computer running the TerraSync software and a real-time correction source into the field to update data. The topics are:

- **Creating a data dictionary from existing data files**
- **Importing data from a GIS into GPS Pathfinder Office**
- **Data transfer**



Creating a data dictionary from existing data files

NOTE This step is only necessary for the tutorial. Normally, before collecting any data, you would create a data dictionary on your desktop PC then use the Data Transfer utility to copy this data dictionary to the field computer, or you would create a data dictionary in TerraSync.

Before you can import data from a GIS, you need to recreate the Seaview data dictionary on your desktop computer.

Each SSF file contains a copy of its associated data dictionary. You will use the Starfish data file to recreate the Seaview data dictionary that is on your field computer.

To create a data dictionary from a data file:

1. Start the GPS Pathfinder Office software and open the TerraSync Tutorial project.
2. Start the Data Dictionary Editor utility. In the GPS Pathfinder Office software, select Utilities / Data Dictionary Editor.

The main Data Dictionary Editor window appears.

3. Select File / Import From Data File.

The Import From Data File dialog appears.



4. Highlight the Starfish.ssf file and click **Open**.

The Import From Data File dialog closes and you are returned to the main Data Dictionary Editor window where a new, unsaved data dictionary has been created.

5. Select File / Save.

The Save As dialog appears. The default filename for the new data dictionary is Seaview.ddf.

6. Change to the c:\Pfddata directory and click **Save**.

7. In the Data Dictionary Editor window, select File / Exit.



Importing data from a GIS into GPS Pathfinder Office

Before going into the field, transfer the required information from the GIS to the TerraSync software. The Trimble Import utility in the GPS Pathfinder Office software converts data from a GIS data format into the **SSF file** format required by the TerraSync software. The Data Transfer utility in the GPS Pathfinder Office software lets you efficiently transfer data between the office computer and the field computer. This part of the tutorial outlines how to transfer GIS data to a field computer running the TerraSync software.

To import GIS data into SSF format:

1. If it is not already running, start the GPS Pathfinder Office software and open the TerraSync Tutorial project.
2. Start the Import utility. In the GPS Pathfinder Office software, select Utilities / Import.

The Import Utility dialog appears.



3. The three Shapefiles you exported at the end of the data collection part of the tutorial should be shown in the Selected Files list. If they are not, click **Browse** and locate the folder
c:\Ppdata\TerraSync Tutorial\Export. Select the input files RoadSign.shp, Road.shp, and Park.shp, and click **Open**.
4. If it is not already selected, select Sample ArcView Shapefile Setup in the Choose an Import Setup group.

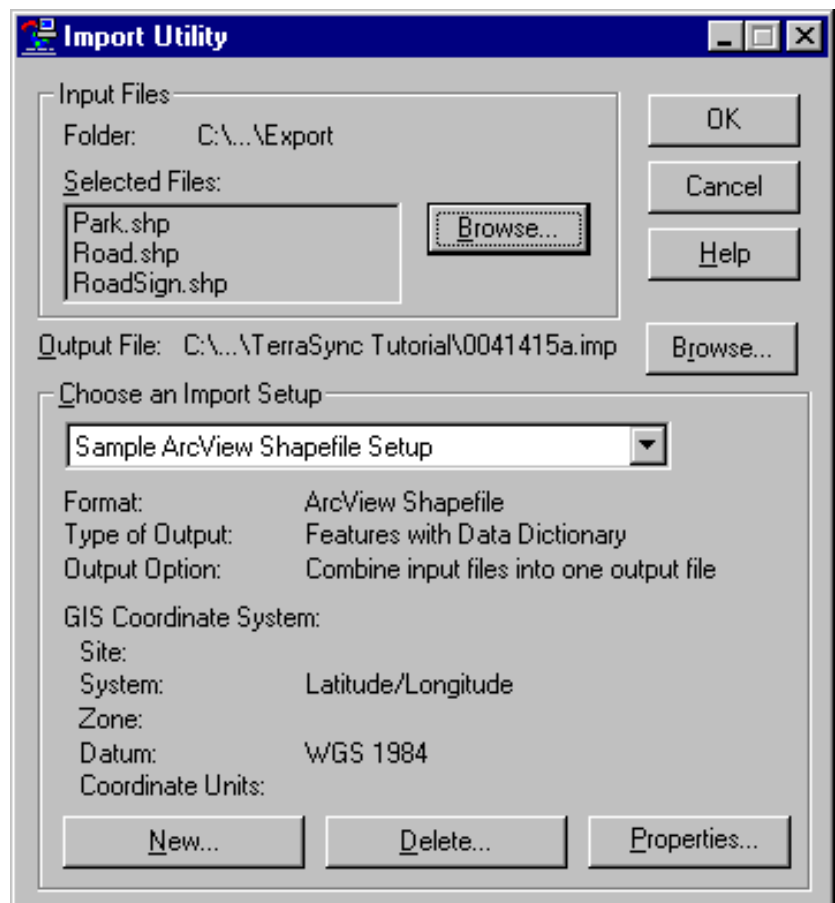

5. Change the import setup properties:

- a. Click **Properties**.

The Import Setup Properties dialog appears:

- b. Make sure the Data tab is selected.
- c. In the Type of Data to Import group, select the Features with External Data Dictionary option.
- d. Click **Dictionary File**. Browse for the Seaview.ddf file, highlight it, and click **Open**.

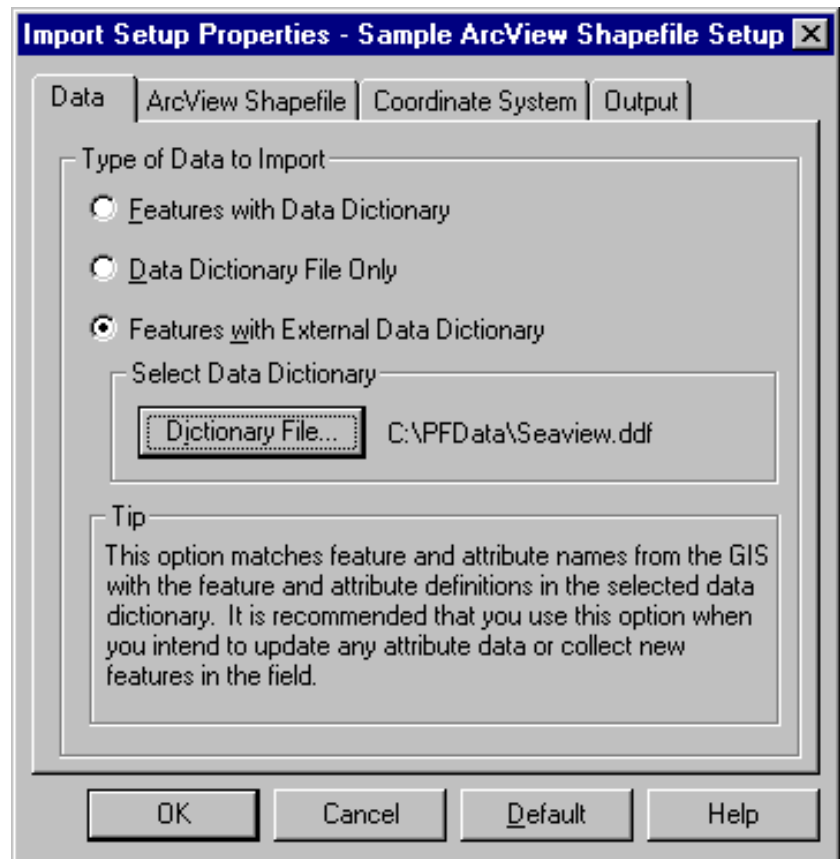

More...



- e. Select the Coordinate System tab and click **Change** to change to the coordinate system the GIS data uses. You must import GIS data using the same coordinate system it is stored in.
- f. Make sure that Latitude/Longitude is selected in the System field, and that WGS 1984 is selected in the Datum field.
- g. Click **OK** to return to the Import Setup Properties dialog.
- h. Select the Output tab.

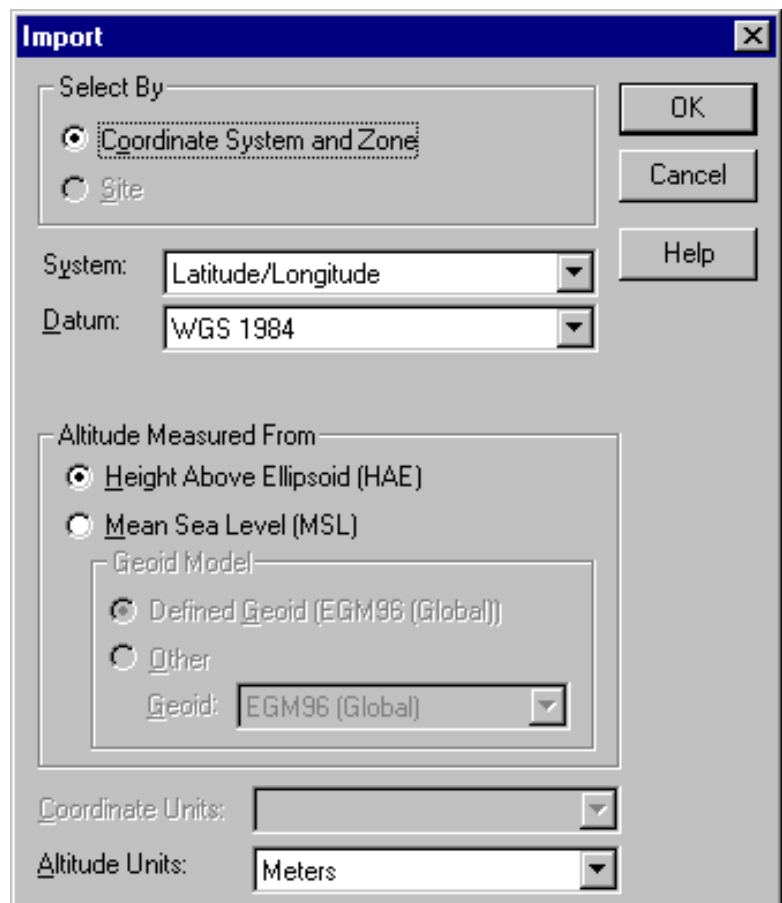

More...



- i. In the Output group, make sure the Combine input files into one output file option is selected.
 - j. Click **OK** to return to the Import dialog.
6. Click the **Browse** button beside the Output File field.

The Specify Output File dialog appears. The default filename is in the format YMMDDHHR.imp.

NOTE An .imp file is a file in **SSF file** format that was created by importing from a GIS, CAD, or spatial database. It is exactly the same as an .ssf file, but has a different filename extension to distinguish it from data files created in the field.

7. In the File Name field, enter **starfish.imp** and click **Save**.
8. Click **OK** to import the file.
9. A message appears, showing information about the import. Click **Close** to close this message.

For more information, refer to the GPS Pathfinder Office Help.

The file Starfish.imp is created from the selected Shapefiles. The next step is to transfer this file to the field computer.



Data transfer

You need to transfer the imported Starfish data file to your field computer, so that you can use it in the field to update existing data. Use the Data Transfer utility in the GPS Pathfinder Office software to efficiently transfer data between the office computer and a field computer running the TerraSync software.

To transfer files from the office computer to your CE device:

1. Switch on your field computer and your office computer and connect the two computers.
 - If your field computer is a CE device, the ActiveSync software should automatically establish a connection with the CE device. When ActiveSync is connected to a CE device, the message **Connected** appears in the main ActiveSync window, and its taskbar icon is green.

If ActiveSync does not connect automatically, connect to the CE device manually. For information, refer to the ActiveSync help, or see **Troubleshooting**.
 - If your field computer is a PC, make sure there is a network connection between the PC and office computer.
 - If the TerraSync software and the GPS Pathfinder Office software are installed on the same computer, you only need to switch the computer on.

More...



2. In the GPS Pathfinder Office software, select Utilities / Data Transfer.
The Data Transfer dialog appears.
3. From the Device list, select the appropriate device (GIS Datalogger on Windows CE or GIS Datalogger on Windows PC). Alternatively, if you have set up a device definition for your field computer, select that device name from the list.
The Data Transfer utility automatically connects to the field computer.
4. Select the Send tab.
5. Click **Add** and select Data File from the drop-down list. The Open dialog appears.



6. The Starfish.imp file appears in the list of files. Highlight it and click **Open**. The Open dialog disappears, and the Starfish data file appears in the Files to Send list:

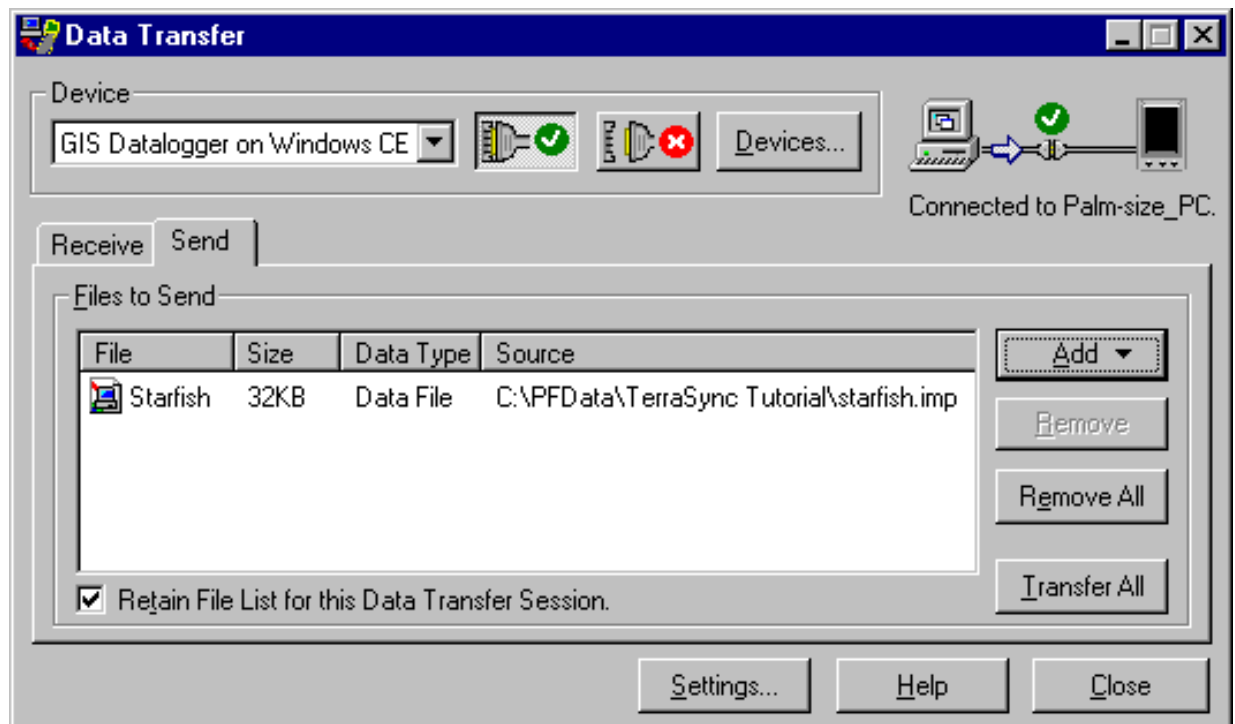

7. Click **Transfer All**.

The data file is transferred to the CE device.

8. A message box showing summary information about the transfer appears. Click **Close** to close it.

9. To close the Data Transfer utility, click **Close**.

10. To close the GPS Pathfinder Office software, select File / Exit in the main GPS Pathfinder Office window.

For more information, refer to the GPS Pathfinder Office Help.



Data update

NOTE You cannot update imported data files using the **TerraSync Standard edition software**. If you have TerraSync Standard edition installed, you cannot perform the data update part of the tutorial.

This part of the tutorial uses the data file you just imported and transferred to your field computer. You are ready to go to Starfish Bay and update features. This section gives the step-by-step instructions required to navigate back to and update features. The topics are:

- **Using real-time differential GPS**
- **Updating data**



Using real-time differential GPS

You can use real-time differential GPS to navigate accurately to existing features. Use [The Navigation section](#) or [The Map section](#) to navigate back to a selected feature.

Topics in this section are:

- [Sources of real-time differential corrections](#)
- [Logging postprocessable positions](#)
- [Checking the real-time status](#)



Sources of real-time differential corrections

You can get real-time corrections from any of the following sources:

- Integrated beacon
- Integrated satellite
- Integrated WAAS
- External source (such as a Beacon-on-a-Belt (BoB) receiver)

You can specify up to four choices for real-time corrections. If your first choice is not available, the TerraSync software automatically uses the second choice until the first choice is available again. This occurs at all levels, so the TerraSync software uses your preferred source of corrections at all times.

If you cannot or do not want to use real-time corrections, set the first choice to Use Uncorrected GPS. No corrections will be applied to your data.

Use [The Setup section](#) to configure the real-time correction sources you want to use.

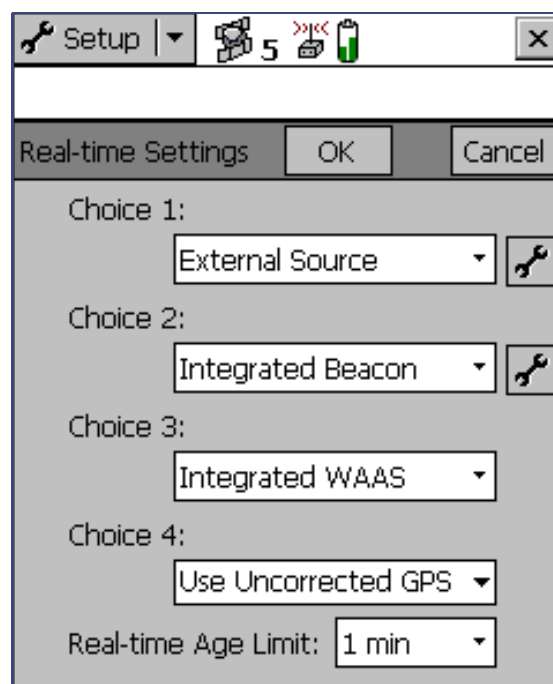

Logging postprocessable positions

When you use a real-time differential correction source, there may be times when you cannot receive corrections. Any positions logged during these times are uncorrected, and are subject to errors which degrade their accuracy.

If you log SuperCorrect GPS positions, you can receive real-time corrections, but you can also postprocess your data in the GPS Pathfinder Office software to improve the accuracy of the real-time corrected positions.

To log SuperCorrect data:

1. Tap the Section list button and select Setup.
2. Tap **Logging Settings**. The **Logging Settings** form appears.
3. In the Log SuperCorrect Data field, select Yes.
4. Tap **OK** to close this form.

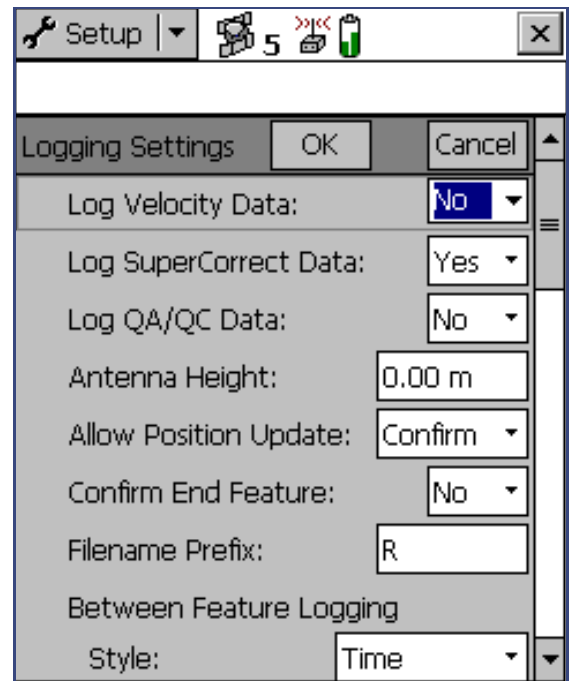

NOTE Logging SuperCorrect data takes up more storage space.



Checking the real-time status

You should always check the real-time status before navigating back to existing features.

TIP You can use the **Status bar** to quickly check the real-time status. When the TerraSync software is receiving real-time corrections, a real-time icon appears in the status bar. The icon flashes if there is a problem with the real-time source.

Use **The Status section** to view detailed information about the real-time status. Tap the Section list button and select Status, then tap the Subsection list button and select Real-time. The Real-time Summary screen appears:

Use this screen to check that the TerraSync software is receiving corrections. When the TerraSync software is receiving corrections, a real-time icon appears beside the source in use. This icon indicates the type of correction source.

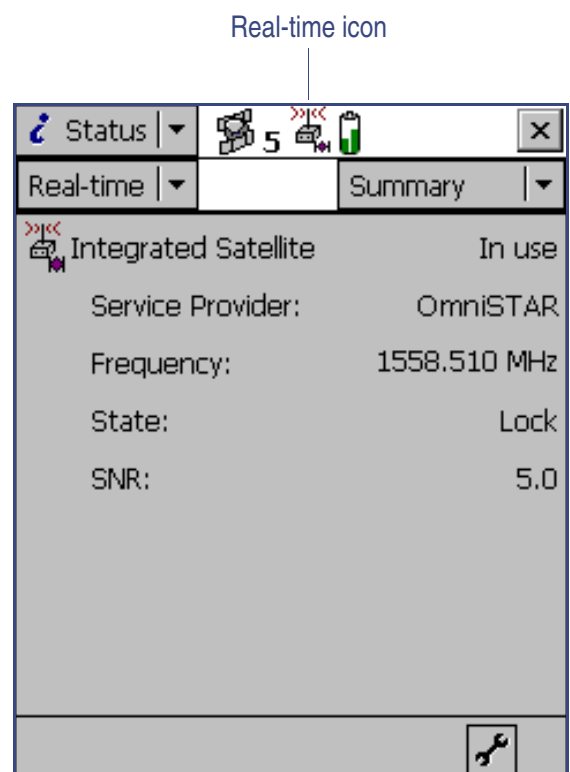

Real-time icon



Updating data

Your supervisor has sent you to Starfish Bay to update information on existing signs.

As you did not record the original road signs you do not know exactly where they are. Use the TerraSync software and, if it is available, a real-time source to navigate to them.

This part of the tutorial gives step-by-step instructions for the following tasks:

- **Opening an existing data file**
- **Filtering features**
- **Selecting a target in the Data section**
- **Navigating to a target in the Navigation section**
- **Updating a feature**
- **Selecting a target in the Map section**
- **Navigating to a target in the Map section**
- **Marking a feature as updated**
- **Closing the file**



Opening an existing data file

Before starting the data update session, open the file that contains the GIS data. Use **The Data section** to do this.

To open an existing file:

1. Tap the Section list button and select Data.
2. Tap the Subsection list button and select Existing File.
3. Highlight the Starfish file. This is the file you imported earlier from the Seaview Authority GIS.
4. Tap **Open** to open the selected file.

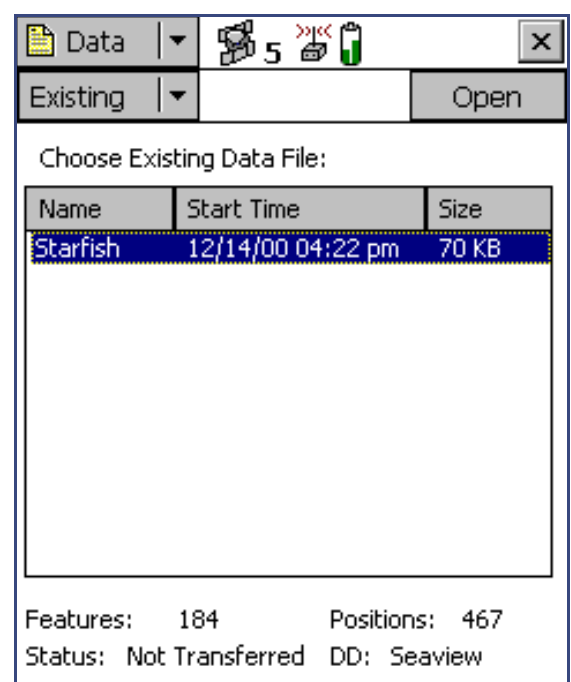

More...



The Update Features screen appears:

This screen shows a list of all existing features in the data file.

You have opened a data file, so you can now start updating features.

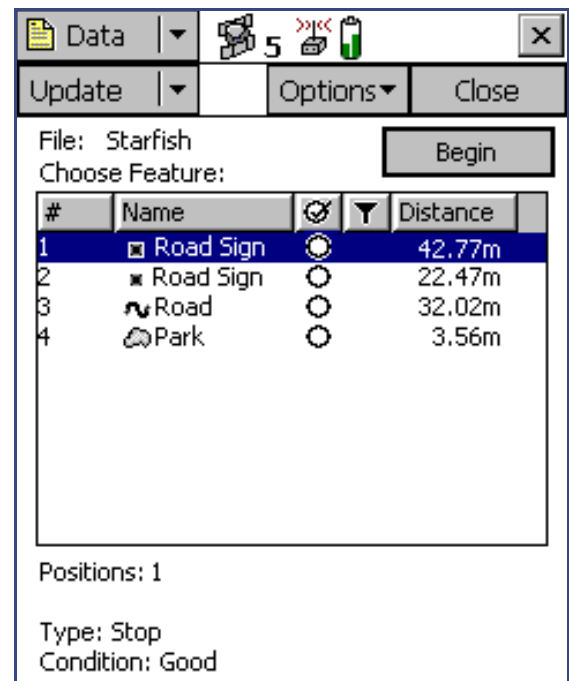

Filtering features

Your first data update task is to locate any road signs that need to be replaced by your field crew.

To make it easy to see which signs you need to visit, you will use filtering to group the features, then select the features you want to update from the filtered group.

You can filter features by their:

- update status
- deletion status
- feature type
- attribute values

The road signs you want to filter have the value Replace in the Condition attribute. To show only these signs, you need to filter by attribute value on the feature type Road Sign.

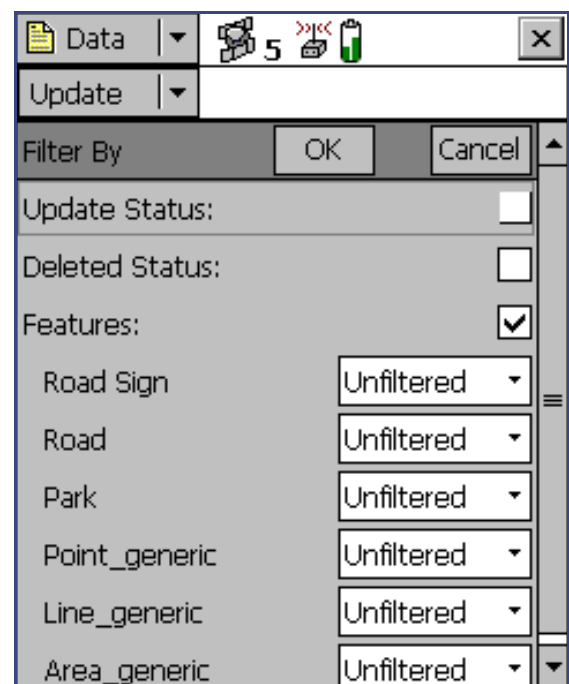

To filter features:

1. Open the Update Features screen in the Data section. Tap the Subsection list button and choose Update Features.
2. Tap **Options** and select Filter. The Filter By form appears.
3. Make sure the Features check box is selected.
4. In the Road Sign field, select Filter By.
The Attribute, Test, and Value fields appear below the Road Sign field.
5. From the Attribute field select Condition:
6. In the Test field, make sure that Equal To is selected.
7. From the Value field select Replace.
8. Tap **OK**.



The Filter By form closes and you are returned to the Update Features form.

If a feature in the Choose Feature list meets the conditions you specified, the filter icon (▼) appears in the Filter column for that feature. There should only be one road sign that meets the filtering conditions.

#	Name	<input type="checkbox"/>	▼	Distance
1	<input checked="" type="checkbox"/> Road Sign	<input checked="" type="checkbox"/>	▼	42.77m
2	<input type="checkbox"/> Road Sign	<input type="checkbox"/>	▼	22.47m
3	<input type="checkbox"/> Road	<input type="checkbox"/>	▼	32.02m
4	<input type="checkbox"/> Park	<input type="checkbox"/>	▼	3.56m



Selecting a target in the Data section

Now that you have filtered the list of features, you can visit each feature displayed and update its attributes. Use **The Navigation section** to locate an existing feature.

To navigate to a feature, select it as your target. Do this using the list of existing features.

To select a target:

1. In the Update Features screen, highlight the filtered road sign.
2. Tap **Options**.
3. Select Set Nav Target.

The target icon  appears beside the selected feature, replacing its point icon.



Navigating to a target in the Navigation section

To open the Navigation section, tap the Section list button and select Navigation. The Direction Dial screen appears:

Use the information displayed on the Direction Dial screen to navigate to the selected target.

This screen displays all the information that you need to navigate to the target. The **Information fields** at the bottom of the screen display different types of navigational information.

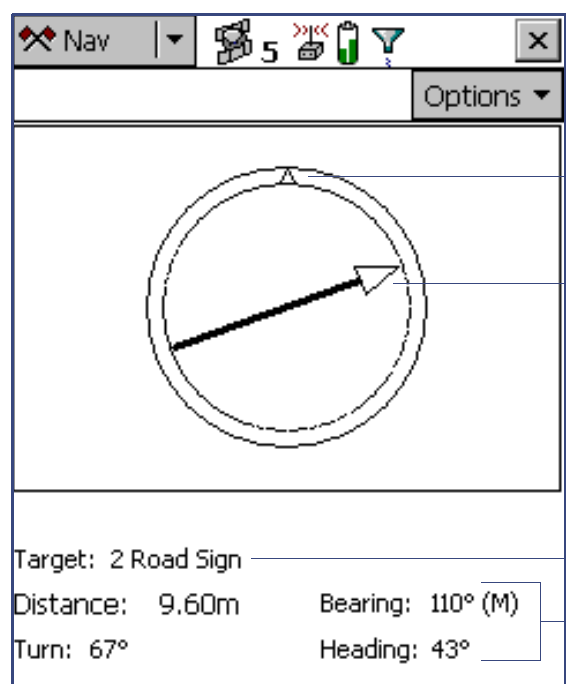

The screenshot shows the Direction Dial screen with the following elements:

- Current heading (direction of travel):** Indicated by a small triangle at the top of the compass.
- Turn arrow indicating direction to target (bearing to go):** A large arrow pointing from the center of the compass towards the target.
- Target name:** "Target: 2 Road Sign" displayed below the compass.
- Information fields:** A box containing "Distance: 9.60m", "Bearing: 110° (M)", "Turn: 67°", and "Heading: 43°".

More...



To navigate to the selected target, start moving so that the TerraSync software can calculate your initial heading. When the direction dial shows the turn arrow, keep moving and turn until the arrow is lined up with your current heading, which is always at the top of the screen. Then move towards the target, adjusting your direction to ensure you are always heading towards the target.

NOTE If you are moving very slowly, or are stationary, the direction dial does not update, and the message **Heading locked** appears.

When you are within a few meters of the target, the view switches to the Close-up screen. In the Close-up screen, your position is indicated by the **X** and the target is represented by the bull's-eye :

As you move closer to the target, the position symbol gets closer to the target symbol. You have reached the target when the position symbol is over the top of the target symbol.

TIP In the Close-up screen, your heading is not updated. It is best to face in the same direction and move sideways, backwards, or forwards, rather than turn.

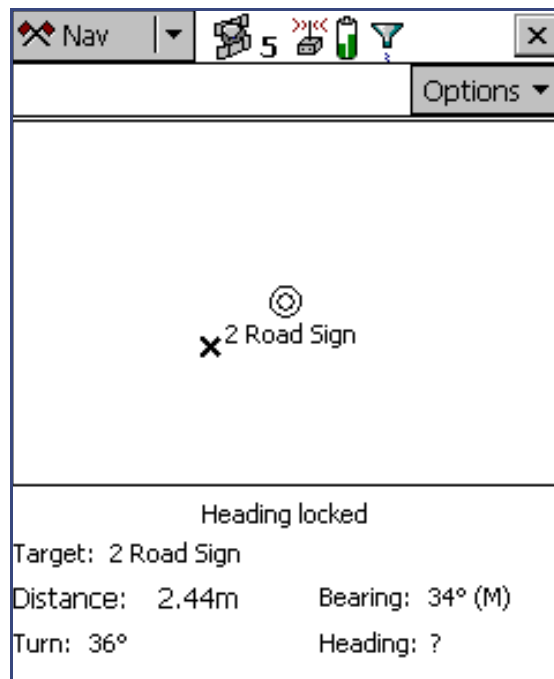

Updating a feature

You have opened the existing file and navigated to the road sign feature. Now you can edit the attributes.

To update a feature:

1. Tap the Section list button and select Data, then tap the Subsection list button and select Update Features.

The Update Features screen appears:

2. The road sign you navigated to should be the highlighted feature in the list. If it is not, select it.
3. Tap **Begin** to display the attribute entry form for this feature. Use it to update the attributes for the sign.

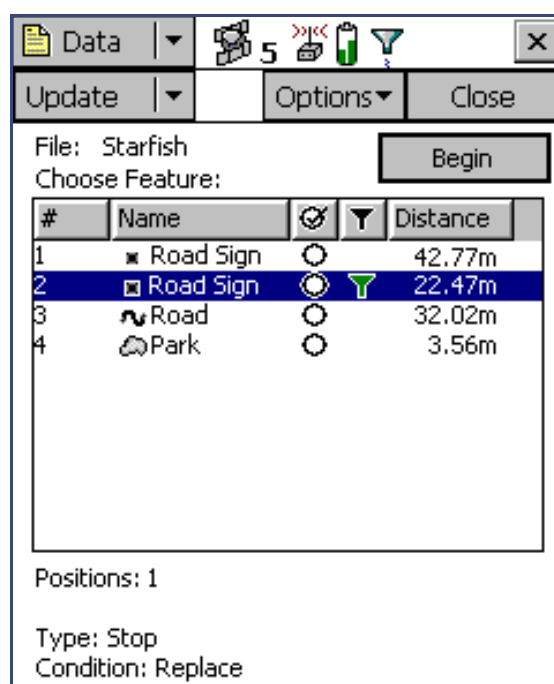

More...



The Date Visited attribute has been set up to auto-generate on update, so as soon as you make any change to the feature's attributes or position it is automatically updated with today's date.

4. The next attribute is the sign type. Use this attribute to verify that you are updating the correct sign. Check that the real sign matches the type recorded in the TerraSync software:
5. You and your field crew have replaced the damaged sign, so in the Condition field change its condition from Replace to Good.
6. Tap **OK** to save the attribute changes and return to the Update Features screen.

For more information, see [Attribute entry form](#).

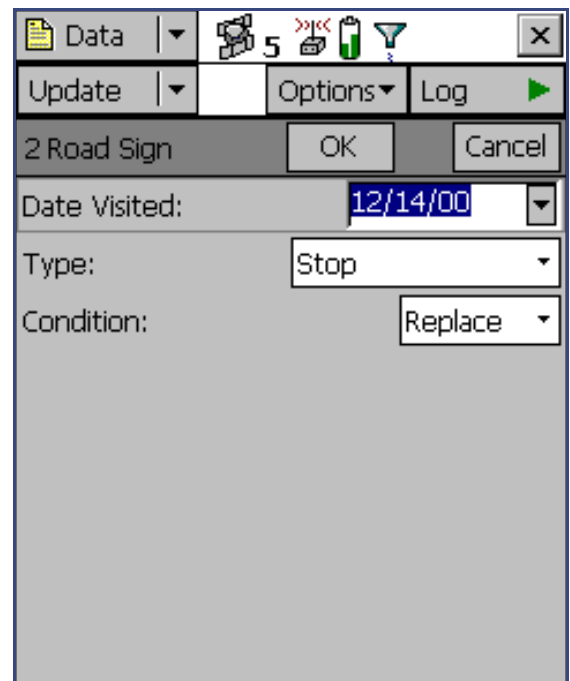

NOTE The Updated column of the [Choose Feature list](#) in the Update Features screen shows the update status of each feature. Any feature that has been transferred from the GPS Pathfinder Office software has an empty circle (○) in this column. When a transferred feature is updated, a check mark (☑) appears in the circle.



Selecting a target in the Map section

Finally, you need to revisit the Road feature, Seagull Street. You will use the Map section to navigate to the beginning of Seagull Street.

To select a target using the Map section:

1. Tap the Section list button and select Map.
2. If necessary, zoom in or out until all the features in the data file are visible.
3. The Seagull Street feature is the only line feature on the map. Tap any part of the line feature to select it:

A selected line feature appears with a wider line than unselected line features.

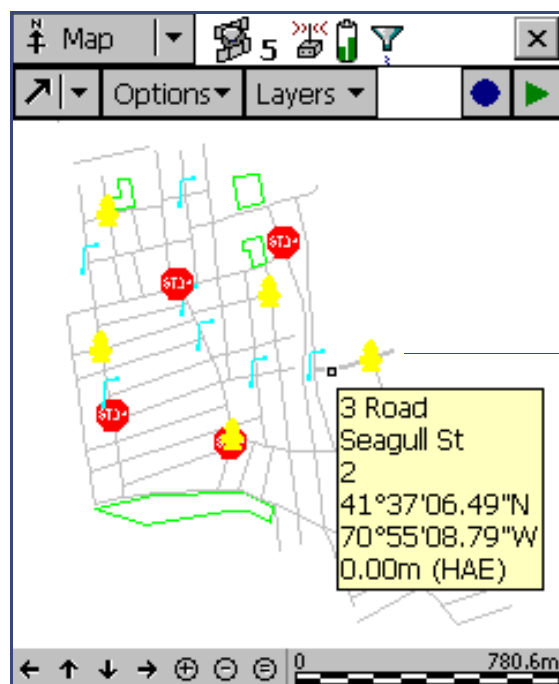

Seagull Street

NOTE Your Map screen may appear different from the one shown.



When you select a feature, a ToolTip appears showing the feature number, name, and position.

4. Tap **Options** and select Set Nav Target. The target icon  appears at the start point of the selected road.



Navigating to a target in the Map section

Once you have selected a target from the map, you can use the map to guide you to this target. The GPS cursor  shows your current position and heading.

To navigate to the target, make sure the heading arrow on the GPS cursor points towards the target as you move.

You may need to use **Zooming** or **Panning** to ensure the target and GPS cursor are both visible. When the target is not in the visible display, the bearing arrow  appears at the edge of the map to show its direction.

NOTE Your Map screen may appear different from the one shown.

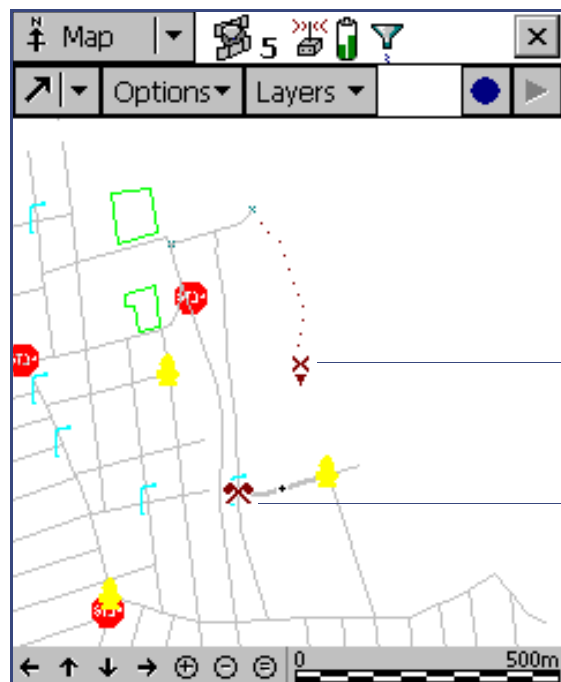

GPS cursor

Target



When the GPS cursor lies over the target icon, you have successfully navigated to the target.



Marking a feature as updated

You have navigated to the road feature. Now you can check its attributes and change its status to Updated.

To update a feature:

1. Make sure the Map section is active. If it is not, tap the Section list button and select Map.
The road you navigated to should be the highlighted feature.
2. Double-tap the road feature to display its attribute entry form.



- All the attribute values are correct, so you do not have to make any changes. Instead, select the Mark as updated check box:
- Tap **OK**. The attribute entry form closes and you are returned to the Map section.

When you change an existing feature's attribute values, change its offset, or update its GPS position, the feature's status automatically changes to Updated, and the Mark as updated check box appears selected.

When you select the Mark as updated check box, the TerraSync software changes the feature status only. It does not change any attributes, offsets, or positions. You can use the Mark as updated function to indicate which features you have visited in the field but haven't changed.



Closing the file

When the data update session is completed, exit the TerraSync software. You do not have to close the data file first. If you exit the software while a data file is still open, the TerraSync software closes the file before exiting.

To exit the TerraSync software:

- Tap the  button in the upper right corner of the window.
A message appears, asking you to confirm that you want to close the file and exit the software.
- Tap **Yes** to close the file and exit the TerraSync software.



ADVANCED FUNCTIONS

When using the TerraSync software to collect and update data, you can take advantage of a variety of advanced functions to provide more accurate and efficient results. The following topics are discussed here:

- **Advanced data collection**
- **Coordinate systems**



Advanced data collection

Advanced data collection methods offer time-saving techniques for efficient field work. Step-by-step instructions are provided for:

- **Advanced datalogging options**
- **Recording between feature positions**
- **Continuing line and area features**
- **Offsets**
- **Using an external sensor**
- **Repeating features**
- **Segmenting line features**
- **Recording averaged vertices**
- **Carrier phase data collection**



Advanced datalogging options

The TerraSync software provides two closely-related options for logging GPS data. These options differ in their timing of GPS data collection relative to the start of a feature.

- **Log Now** – start a feature, and simultaneously start collecting GPS positions.
- **Log Later** – start a feature, and start collecting GPS positions later.



Log Now

Data / Collect Features / Options / Log Now

When the Log Now option is selected, logging of positions for a new feature begins as soon as you select the feature type and tap **Create**. You can enter attribute values while positions are being recorded.

Log Now is the default logging option. When Log Now is selected, a bullet (•) appears beside it in the option list.

To select Log Now, tap **Options** in the **Collect Features** screen, then select Log Now from the option list.

NOTE Log Now applies only to new features. When you open an existing feature for update, logging is paused and the pause icon flashes in the **Status bar**. New positions are logged for an existing feature only after you tap **Log** in the attribute entry form and select the Update position option.



Log Later

Data / Collect Features / Options / Log Later

When the Log Later option is selected, logging of positions for a new feature begins only after you tap Log in the attribute entry form. Until you begin logging, the pause icon flashes in the **Status bar**.

When Log Later is selected, a bullet (•) appears beside it in the option list.

To select Log Later, tap **Options** in the **Collect Features** screen, then select Log Later from the option list.



Recording between feature positions

The GPS data that you collect with the TerraSync software is recorded in files. You can collect positions in a file without collecting feature and attribute data. These positions are called **between feature positions**. They appear in their own layer on the Map graphical screen.

Recording GPS positions only is a useful technique when you do not need to record feature and attribute data. For example, you may want to record a trail of the day's activities to track where you have been. In this case, you would not want to collect feature or attribute information, only the positions. You can also use between feature logging to record the route traveled from one feature to the next.

By default, the TerraSync software does not record between feature positions. Use the **Logging Settings** form in the Setup section to enable between feature logging. If the Interval field contains a time or distance value, then between feature logging is enabled. If it is set to Off, then between feature logging is disabled.

Between feature positions can be spaced by distance or time. For example, you can use the distance option to force the TerraSync software to log a position every three meters you travel, or the time option to log a position every five seconds. To set the logging interval, select the logging style (Distance or Time) from the Style field, then enter the rate in the Interval field.

If between feature logging is enabled, the TerraSync software logs positions (at the rate you have specified) whenever you are not logging positions to a feature.



Continuing line and area features

 **Data / Collect Features / Options / Continue**

 **Data / Update Features / Options / Continue**

When recording a line or area feature, you could come across another feature that you need to record. The feature may be adjacent to the line/area feature, or it may be some distance away. When collecting a path (line feature), for example, you might encounter a gate (point feature). You do not have to record the entire path and then return to record the gate. Simply end the path feature, collect the gate feature, and then use the Continue option to continue the path feature you were collecting.

NOTE Other Trimble GIS data collection products refer to this functionality as *nesting*.

You can continue any line or area feature, not just the last one you collected, provided you have not continued any other features since collecting it.

Once you continue a feature, any line or area features you collected between its two segments become unavailable for continuation, because they are now nested within the continued feature. Any features you collected before the continued feature are also unavailable for continuation.



New features that you collect after the continued segment will be available for continuation, because you have not continued any other feature since they were collected. If you replace an existing feature's positions with new GPS or digitized positions for a feature, the Continue function treats it as a new feature, so it can also be continued.

NOTE You can collect as many features within a line or area as you need. The number is limited only by storage space on the field computer.

To use Continue:

1. In the attribute entry form, tap **OK** to close the line or area feature you are collecting. The **Collect Features** screen appears.
2. In the Choose Feature list, highlight the feature that you want to collect and tap **Create**. The attribute entry form appears and logging starts.
3. When you have recorded attributes for the feature and logged sufficient GPS positions, tap **OK** to close the feature. The **Collect Features** screen appears again.
4. Tap **Options**. From the option list, select Continue.



The **Continue feature form** appears, listing all the line and area features that are available for continuation, in the order they were collected:

5. Select a feature from the list and tap **Continue**.

The TerraSync display returns to the attribute entry form for the selected line or area feature, and continues to log GPS positions for that feature.

6. When you complete the traverse of the line or area perimeter, tap **OK** to store the feature.

TIP

You can also continue a selected feature from the Update Features subsection, or from the Map section. Do one of the following:

- Highlight the feature in the Update Features screen, tap **Options**, and select Continue.
- Open the feature for update from the Update Features section or the Map, then begin logging GPS or digitized positions. A dialog appears, asking you to specify the logging option you want. Select the Continue feature option and tap **OK**.

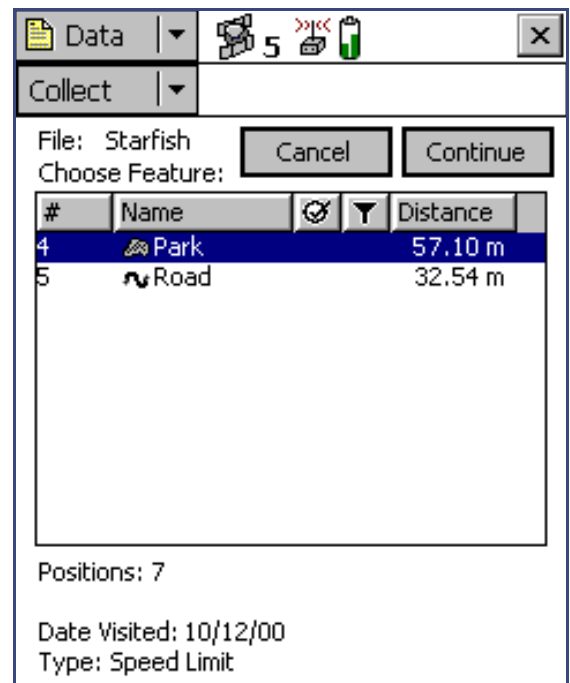

Offsets

Data / Collect Features / Create / Options / Offset or

Data / Update Features / Begin / Options / Offset

If you cannot travel over the top of, or right next to, a feature, you can enter an offset and record it at the specified distance. When collecting a tree feature, for example, it may be easier to stand some distance (for example, 10 paces to the North) from the tree and record its attributes. This ensures good GPS reception, and lets you see the tree clearly to assess its condition. Specify an offset to the tree of 10 m South. This is an example of an **offset point feature**. Entering an accurate offset ensures that the feature is positioned correctly in the GIS.

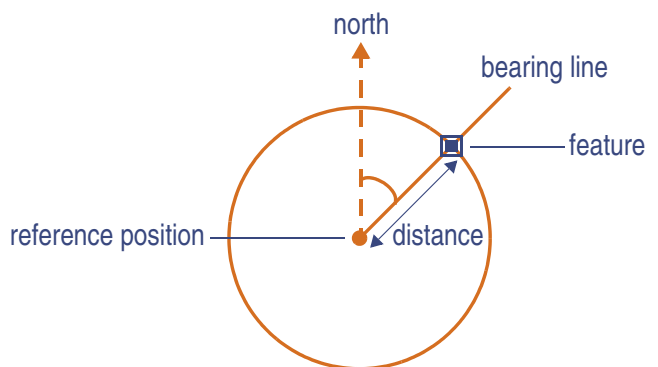

NOTE

The example above is a simple distance-bearing offset. For point features, you can also record **complex offsets**, which use measurements from two or more reference positions to calculate the feature position. For more information, see **Complex offsets**.

More...



To view or enter the offset for the feature being collected or updated, tap **Options** in the attribute entry form, then select Offset.

You can also use offsets for line and area features. When collecting a line feature such as a fence, it may be easier to drive along the road beside the fence and record the positions of the fence as an offset. Another example is when collecting an area feature such as a lake, you could walk some distance from the lake edge and record its perimeter using an offset. The diagrams below show these examples:

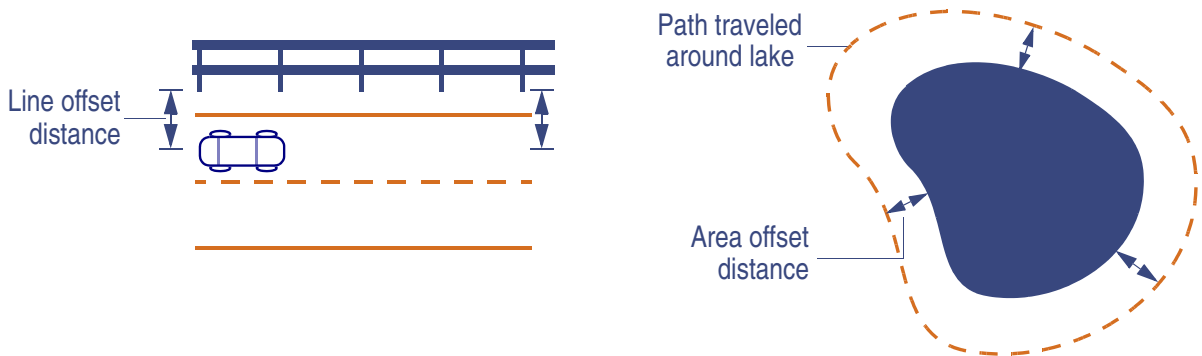

NOTE Any feature (point, line, or area) can have only **one** offset associated with it. To collect a line or area feature using offsets, the same offset value must apply to the whole feature. This may require a test run around or along an object to make sure that you can remain a consistent distance from it.

[More...](#)



TIP You can use segmenting to record a feature as a series of joined line segments, each with a different offset. For more information, see [Segmenting line features](#).

Offsets are added to GPS and digitized positions as they are recorded, and features are displayed in the Map section with their offsets. However, if the currently open line or area feature has an offset, acute angles and corners can appear distorted on the map. This is because exact offset values are not calculated for these positions until the feature is closed. When you close a feature, offsets for these positions are interpolated, and the feature is redrawn more accurately.

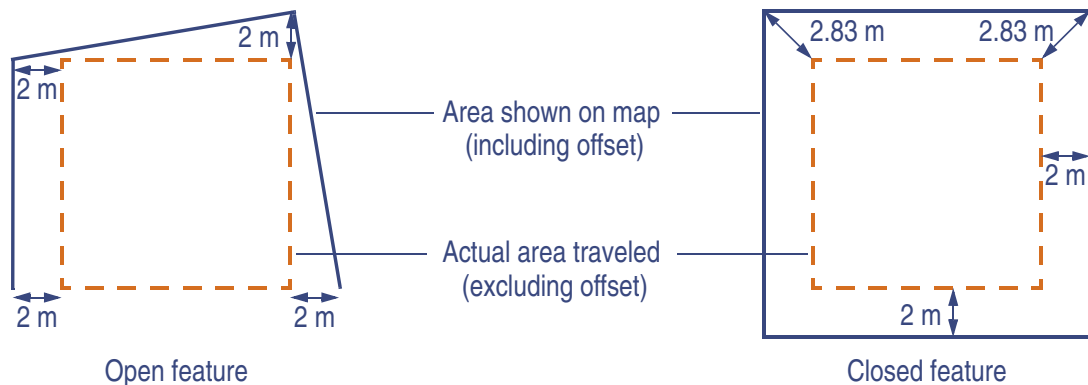

[More...](#)



To record an offset for a feature:

1. Start the feature.
2. From the attribute entry form, tap **Options** and select Offset.
3. If the current feature is a point feature, select the type of offset you want to record, then tap **OK**. The appropriate offset form appears:

The fields in the offset form depend on the type of feature you are collecting (point, line, or area) and the type of offset you are collecting.

4. Enter a value in each field as necessary. Alternatively, use data from a laser rangefinder. For more information, see **Using a laser rangefinder to record offsets**.
5. When the offset form is complete, tap **OK**. The attribute entry form reappears.
6. When you have recorded attributes for the feature and logged sufficient GPS positions, tap **OK** to store the feature. The **Collect Features** screen appears.

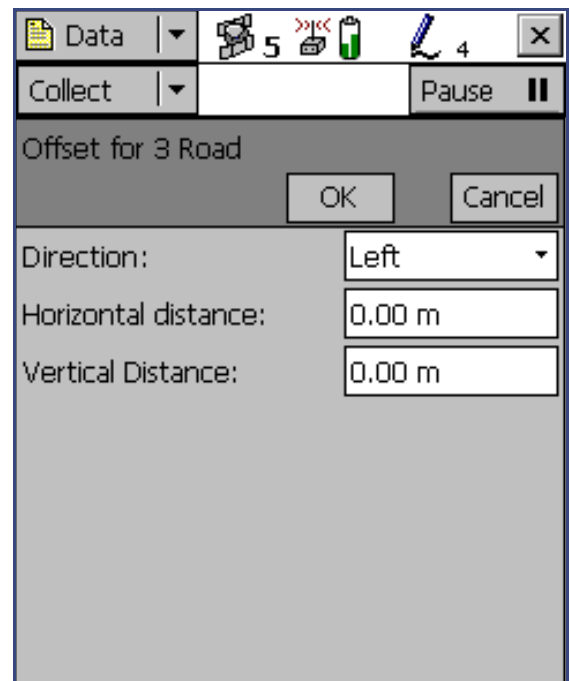

NOTE You can also record **Complex offsets** for point features.



Complex offsets

When you record a complex offset, you do not record any position information for the feature. Instead, you record GPS positions for two or three reference positions and measure the distance or direction from each reference position to the feature. Then TerraSync uses coordinate geometry (COGO) to calculate the location of the feature, in much the same way as a GPS receiver uses the distances to GPS satellites at known locations to calculate GPS positions.

In TerraSync, you can record a complex offset using either two or three reference positions, and you can specify either the distance to the feature, or the bearing (direction).

To increase accuracy, you can record each reference position as if it were an averaged vertex. If you log a number of positions at each reference point, TerraSync averages these positions to give a more accurate reference position. The principle of **Dilution of Precision** applies to complex offsets, so you should choose reference positions that are widely spaced.

- **Recording a complex offset**
- **Distance-distance offset**
- **Triple distance offset**
- **Bearing-bearing offset**
- **Triple bearing offset**



Recording a complex offset

To record a complex point offset:

1. Start the point feature.
2. From the attribute entry form, tap **Options** and select **Offset**.
3. In the **Point offset type form**, select the type of offset you want to record, then tap **OK**. The appropriate offset form appears:
4. Follow the instructions at the top of the form. When you have completed each step, tap **Next** to move to the next step. The steps required for each reference position are as follows:
 - a. Move to the reference position.
 - b. Tap **Log** (or **Resume**) to begin logging.
 - c. Remain stationary at the reference position while you log positions. When you have collected sufficient positions, tap **Next** to stop logging.

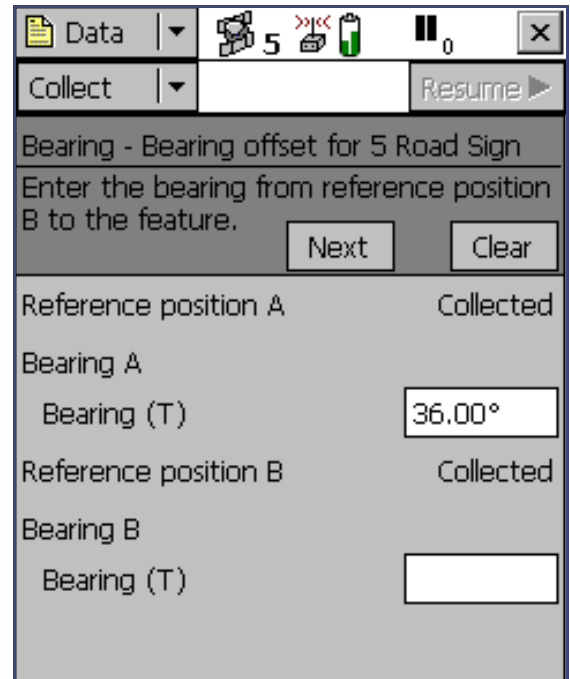

- d. Measure the offset (the distance or the bearing from the reference position to the feature). You can use data from a laser rangefinder. For more information, see **Using a laser rangefinder to record offsets**.
 - e. Tap **Next** to confirm the measurement for this reference position.
5. If required, enter the direction that the features lies in relative to the path between the reference positions. This is only necessary if you are recording an offset that uses distances. The software calculates the feature's position.
 6. When the offset form is complete tap **OK**. The attribute entry form reappears.

NOTE Logging is paused, because you only have to record positions for the reference positions, not the feature itself.
 7. When you have recorded attributes for the feature, tap **OK** to store the feature. The **Collect Features** screen appears.



Distance-distance offset

A distance-distance offset uses the distance between the feature and two reference positions (A and B) to specify the feature's position. The feature lies at the point where the circles centered on A and B intersect. Because there are two points where the circles intersect, you need to specify which direction the feature is in, relative to the path from A to B.

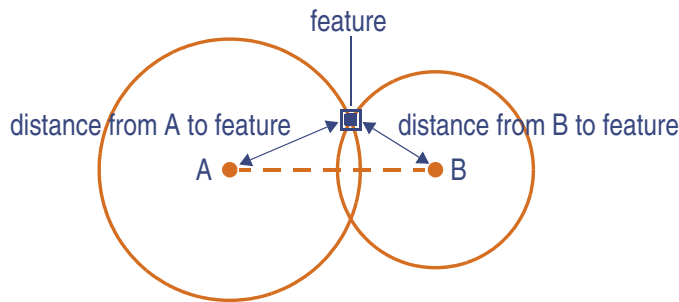

Triple distance offset

A triple distance offset uses the distance between the feature and three reference positions (A, B, and C) to specify the feature's position. The feature lies at the point where the circles centered on A, B, and C intersect. There can be only one point where the three circles intersect, so you usually do not need to specify a direction.

A triple distance offset is similar to a distance-distance offset, but a third measurement provides some mathematical redundancy that can improve accuracy.

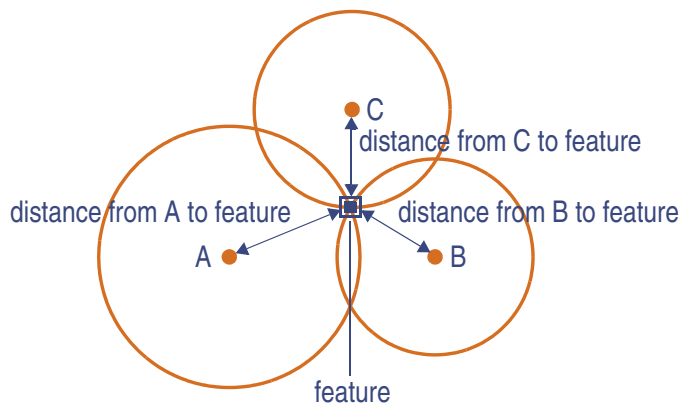

Bearing-bearing offset

A bearing-bearing offset uses the bearing from north from each of two reference points (A and B) to the feature to specify the feature's position. The feature lies at the point where the two bearing lines intersect.

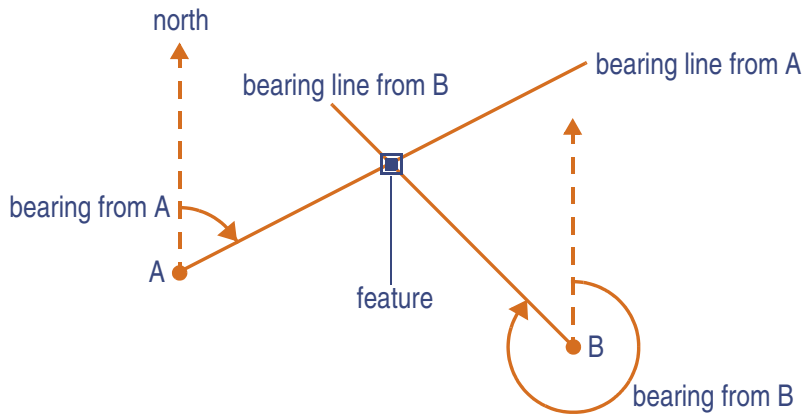

Triple bearing offset

A triple bearing offset uses the bearing from north from each of three reference points (A, B, and C) to the feature to specify the feature's position. The feature lies at the point where the three bearing lines intersect.

A triple bearing offset is similar to a bearing-bearing offset, but a third measurement provides some mathematical redundancy that can improve accuracy.

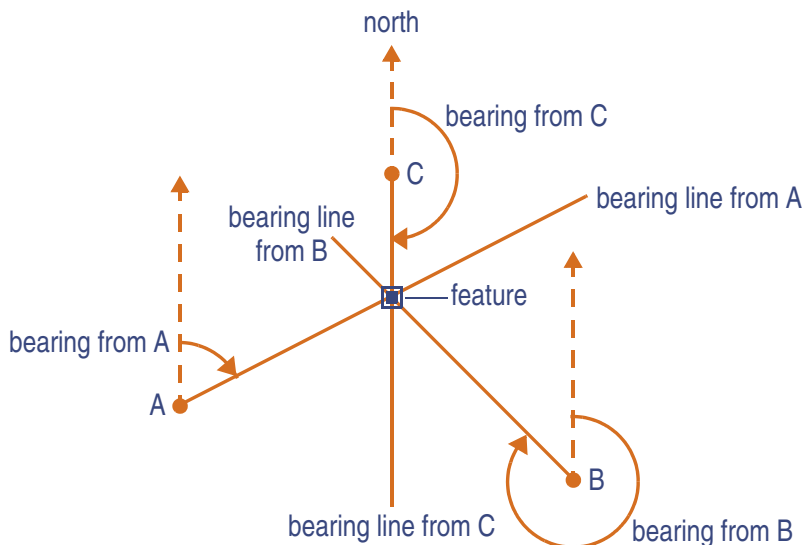

Using a laser rangefinder to record offsets

You can use a laser rangefinder to record accurate offsets for any feature. To use a rangefinder with the TerraSync software, you only need to specify which serial (COM) port on the field computer the rangefinder is connected to.

For a list of the laser rangefinders that the TerraSync software supports, visit the [Trimble website](#).

To record an offset from a laser rangefinder, make sure that there is a feature open, and that the feature's attribute entry form, the appropriate offset form, or the Map screen is open. Then fire the laser rangefinder. The TerraSync software stores the distance and, if the laser rangefinder supports it, the bearing, in the appropriate field(s) in the offset form.



Before storing an offset from a laser rangefinder, TerraSync subtracts the **Antenna Height** specified in the Setup section from the measurement. An incorrect antenna height can reduce the vertical accuracy of the feature's position. If vertical accuracy is important, make sure that you:

- set the antenna height to the vertical distance from the laser rangefinder to the antenna (rather than the distance from the ground to the antenna). You can use a configuration file to do this.
- keep the laser rangefinder as close to the antenna phase center as possible when shooting.
- shoot at a higher position on the feature to compensate for the antenna height being subtracted from the feature's altitude.

For more information on configuring a laser rangefinder to work with the TerraSync software, see **External Sensors**.

You can also use a laser rangefinder as an external sensor. For more information, see **Using an external sensor**.



Using an external sensor

You can use an external sensor with the TerraSync software. The data recorded by the sensor can be stored in an attribute, or it can be stored in the data file as an uninterpreted sensor data record. You can export uninterpreted sensor data from the GPS Pathfinder Office software to your GIS or processing software.

Depending on the way you want to store the sensor data, and the capabilities of the sensor, you can configure TerraSync to read data from the sensor at specified intervals, or only when you request it.

For more information on configuring an external sensor to work with the TerraSync software, see [External Sensors](#).

NOTE A laser rangefinder can be used either as an external sensor, as described above, or to supply data for feature offsets. For more information, see [Using a laser rangefinder to record offsets](#).

NOTE When you open an existing file that contains uninterpreted sensor records, new sensor records are not collected until GPS logging begins. If you only want to activate logging of sensor records, you can start logging positions to a new feature and then cancel the feature.



Repeating features

Data / Collect Features / Options / Repeat

Use Repeat to efficiently record a sequence of similar features. When you use Repeat, attribute values are copied from the last recorded feature of that type. You do not have to re-enter values for all attributes. Just check that each attribute value is correct for the new feature, and change only those that are different.

To repeat attributes for similar features:

1. In the **Collect Features** screen, tap **Options** and select Repeat. When Repeat is selected a check mark (✓) appears beside it in the option list.
2. Select a feature from the Choose Feature list and tap **Create**. The attribute entry form appears. The attribute values that appear are those of the last recorded feature of that type. Edit them if necessary. Tap **OK** to save the attribute values and store the feature.
3. Select another feature. Continue until you want to turn off Repeat mode.

To turn off Repeat mode:

- In the **Collect Features** screen, tap **Options** and select Repeat. The check mark disappears.

NOTE When Repeat is not selected, the data dictionary determines default attribute values. Where appropriate, the data dictionary specifies a default value for each attribute of a feature.



Segmenting line features

Use segmenting to record a line as several segments that are joined together, each with different attribute values. For example, you can record a road feature that has one surface for part of its length, and a different surface for the rest of its length.

When you segment a line feature, the TerraSync software immediately records a position, even if the logging interval does not require a position at that time. This position becomes the last position in the old line and the first position in the new line. Recording a position at the segmentation point ensures that the two line segments join up in the GPS Pathfinder Office software and your GIS.

The offset of the new line segment defaults to the offset of the previous line segment, if there is one. The new line feature has the same attribute values as the previous line segment, except that any auto-incrementing attributes are incremented to the next value.

NOTE If the line feature has an offset, the two line segments may not “snap” together.

To segment a line feature:

1. While logging a line feature, in the **Attribute entry form** tap **Options** and select Segment Line. The TerraSync software ends the current line feature and immediately starts another line feature of the same type.
2. If necessary, edit the new feature’s attributes.



Recording averaged vertices

A line or area feature consists of a number of positions, joined in sequence from the first position logged to the last. Each position represents a **vertex** of the feature. For more accurate recording of line and area features, you can record several positions at each vertex, then average these positions together to calculate the vertex position.

Logging a line or area feature with averaged vertices is similar to logging a number of point features, each being the average of a number of positions, then joining these point features together in sequence.

To record an averaged vertex for a line or area feature:

1. In the **Attribute entry form** for the line or area feature, tap **Options** and select New Vertex. The Vertex form appears. This form contains the same fields as the attribute entry form. Logging of positions for the averaged vertex begins immediately. The logging icon in the status bar changes to an animated circle zooming in  **4**, and the number beside it shows the number of positions logged for this vertex.
2. If necessary, enter or edit attribute values for the feature.
3. When you have logged as many positions as you require for this vertex, close the Vertex form. You are returned to the attribute entry form.



An averaged vertex is similar to a point feature, and the same limitations that apply to a point feature apply when the Vertex form is open. You cannot segment a line feature while recording an averaged vertex. You can enter or edit the feature's offset, using the line/area **Offset form**. While the Vertex form is open, you must remain stationary, as though you were recording a point feature. The messages **Vertex # open** and **Remain stationary** appear to remind you to stay still. The number of positions recorded for this vertex also appears in the status bar.

A line or area feature can include both averaged vertices and positions logged normally as you travel. If you want to record only averaged vertices, use the **Log Later** function to pause logging before you open the feature. Whenever you open the Vertex form, logging starts, and when you close the Vertex form, logging returns to its former state. This technique ensures that no positions are logged except those you log for averaged vertices.



Carrier phase data collection

When you need to collect a feature with a precision better than 50 cm, you can configure the TerraSync software to log carrier phase data. When the TerraSync software logs carrier phase data, positions collected in the field can be postprocessed to generate more precise positions once you are back at the office. Because measurements are collected from each individual satellite, the positions generated during postprocessing are **more precise** than positions logged in the field.

You require a clear view of the sky at all times when collecting carrier phase data, so avoid obstacles such as trees, bridges, and tall buildings. Choose a time of day when you can expect to track a maximum number of satellites with the best possible geometry.

NOTE Carrier phase data collection is not available when you are using the GPS Pathfinder Pocket receiver.

This section includes the following:

- **Collecting sufficient data**
- **Configuring carrier accuracy features**
- **Logging carrier phase data**
- **Logging base data files**



Collecting sufficient data

To provide sufficient carrier phase data to achieve the required precision, the TerraSync software needs to log data from at least **four** satellites for the minimum time specified. “Loss of lock” occurs when the number of available satellites drops below four.

When you are logging carrier phase data, as soon as four or more satellites are available a counter starts. When the minimum time has elapsed, all of the carrier phase data recorded during **that** period can be used during postprocessing. When the counter reaches the minimum time, a success beep sounds. This indicates that the current “block” contains **sufficient** useful data.

For more information, see [What is a “block” of data?](#).

NOTE The minimum time for a “block” of carrier phase data is 10 minutes. You cannot change this value.

If you lose lock before the end of the minimum time, the data collected until then may not provide the required precision during postprocessing. The counter is automatically reset to zero when loss of lock occurs. It only restarts when lock is regained.

NOTE Carrier phase data is not logged from satellites that are below the current **Min Elevation**. Before logging carrier phase data, check that the minimum elevation is set to an appropriate value.



What is a “block” of data?

When you start a file, the TerraSync software starts to record carrier phase measurements. Useful data is not stored as one continuous stream, however, but as a series of “blocks”.

The beginning and end of each block is determined by the number of available satellites. As soon as four or more satellites are available, a new block begins. This block continues until lock is lost. When lock is regained, a new block begins.

The TerraSync software continues to create blocks of data throughout the file.

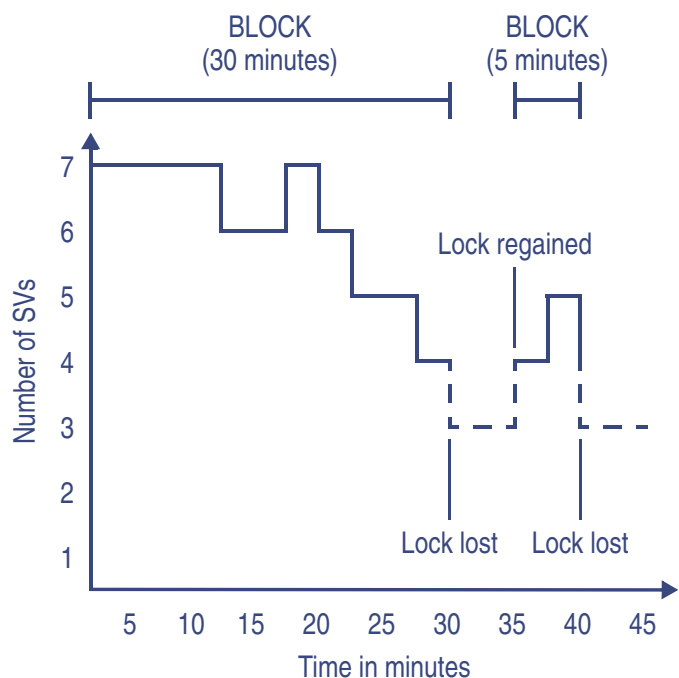

Configuring carrier accuracy features

You can configure individual feature types in a data dictionary to use carrier phase data. You can do this when you create the data dictionary in the Data Dictionary Editor utility in the GPS Pathfinder Office software, or in the Data section's **File Manager** subsection. For more information, refer to the Data Dictionary Editor Help.

Alternatively, you can set any feature type to carrier accuracy in the TerraSync software:

1. In **The Data section**, open the data file that you want to record carrier data to.
2. Tap the Section list button and select Setup to open **The Setup section**.
3. Tap **Logging Settings**.

The **Logging Settings** form appears. At the end of the form, there is a section for each feature type in the open data file.

4. Locate the section for the feature type you want to set to carrier accuracy.
5. Make sure the Style field is set to Time.
6. In the Accuracy field, select Carrier.
7. Click **OK** to close this form and confirm the changes you have made.

Carrier phase data logging is now enabled for all features of this type in this file.



Logging carrier phase data

When you open a new data file, the TerraSync software checks whether any features in the data dictionary are set to carrier accuracy. If any are, the TerraSync software starts to log carrier data in the background. This allows the carrier block to start as soon as you open the file, not just when you begin to log a feature. When you start a new feature that is set to carrier accuracy, the software logs carrier data in the foreground so that this feature can be processed with carrier phase accuracy. The carrier logging icon appears in the **Status bar**, and the satellite icon shows the carrier time.

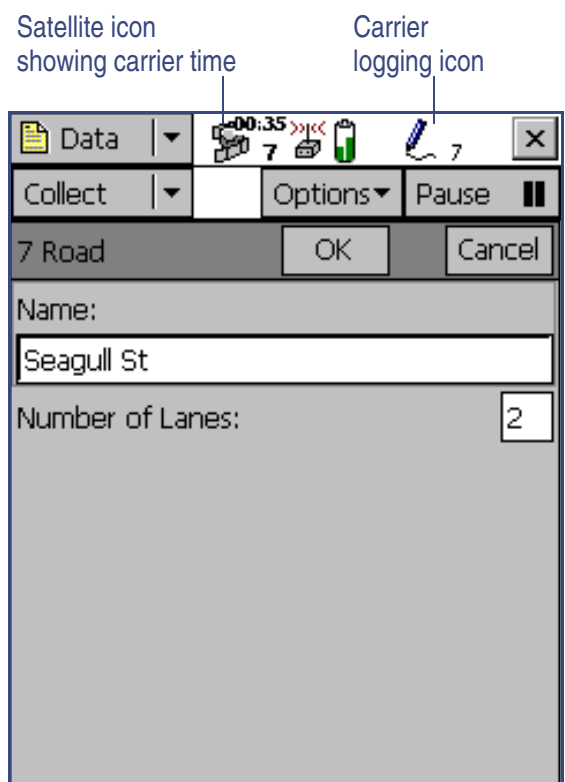

More...



When you open an existing file with carrier features, the TerraSync software does not automatically log background carrier data. Carrier logging only begins when you start logging positions to the file. These may be not-in-feature positions, position records for a new feature, or updated positions for an existing feature.

As you log carrier phase data, the satellite icon shows the time elapsed, in minutes and seconds, since the current block of data started. This is referred to as **carrier time**. This time also appears in the Carrier time field in the **Receiver** screen. When the TerraSync software has logged carrier phase data continuously for the minimum time (10 minutes), the success beep sounds.

If you try to close a file before the minimum time is up, the TerraSync software asks you to confirm that you want to close the file. If you do close the file, you may lose carrier accuracy for some features.

Once the counter is running, you can choose to end the current feature and stay where you are until the minimum time is up. When the success beep sounds, move to the next feature. Using this method, you can be sure that you have sufficient data to generate precise positions.

Alternatively, if you think you are unlikely to lose lock, you can move to the next feature **before** sufficient carrier phase data has been collected. This is possible because all features recorded during a block achieve the precision associated with that block. Provided that a block eventually contains enough useful data, you can generate precise positions for any feature recorded within it.

WARNING Only move to the next feature before the minimum time is up if loss of lock is unlikely.



Logging base data files

The TerraSync software does not have a Base Station mode. However, you can log a data file that can be used as a base file. To do this, open a new data file and log a single point feature with carrier accuracy and a logging interval that matches the one set in the rover files. After you transfer this file to the GPS Pathfinder Office software, you can use it as a base data file in the Differential Correction utility.

TIP If you name these base files using the filename prefix “B”, then the Differential Correction utility can easily locate and correctly identify these files when it searches for base files.



Coordinate systems

When using the TerraSync software to collect GPS data, you can configure the coordinate system, zone, and datum. This lets you enter and display coordinates using the coordinate system that best suits you and the location you are working in. The following topics are discussed:

- **Coordinate systems and datums**
- **Coordinate systems available in the TerraSync software**
- **Using the Coordinate System Manager utility**
- **Transferring coordinate systems**
- **Configuring coordinate systems**



Coordinate systems and datums

Coordinate systems are three-dimensional reference frames used to describe the location of objects in space. The TerraSync software provides you with your position anywhere on the earth's surface in relation to the coordinate system you have configured.

Before you can compare geographic data obtained from different sources, the data must be referenced to the same **datum** and coordinate system. This is because different datums and coordinate systems provide different coordinate values for a single geographic location.

GPS positions are normally expressed as latitudes and longitudes relative to a mathematical model called a datum. The datum used by GPS is called the World Geodetic System 1984 datum (or WGS-84). A datum is defined by the relationship between an **ellipsoid** and an origin point. An ellipsoid is a three-dimensional surface shaped like a squashed sphere, which approximately models the shape of the earth (either as a whole, or over a particular part of the earth). The WGS-84 datum is defined in terms of the GRS-80 ellipsoid.

For most land-based GPS applications, and particularly for GIS data collection applications, latitudes and longitudes are much less convenient. Typically, a GIS will represent the coordinates of geographic features in a locality of interest using a rectangular grid (running North and East) and will presume that the earth is locally flat. A local ellipsoid can be defined to provide a good approximation to the shape of the earth in that area. A datum transformation and a map projection are then used to transform coordinates from this local ellipsoid to the flat-earth model in the GIS.

[More...](#)



Heights can be displayed by the TerraSync software relative to either a local ellipsoid, or an empirically defined surface known as the **geoid**. The geoid is a surface over which the earth's gravity is constant. (The geoid represents mean sea level.)

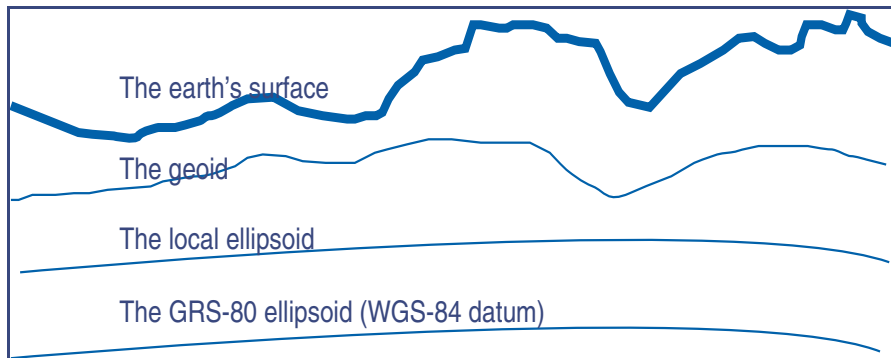

In summary, there are three models for describing geographic locations:

- The flat North, East model of the GIS, possibly with heights as well
- The curved local ellipsoid, used by the GIS as a model of the earth's surface locally
- The curved GRS-80 ellipsoid, used by GPS as a model of the earth's surface as a whole

These models can describe heights as being relative to either an **ellipsoid** or the **geoid** (mean sea level).



To collect the positions of features using GPS (and hence the WGS-84 datum) and then send them to a GIS as North, East coordinates, the GPS latitudes and longitudes need to be processed in a number of ways.

First, they need to be transformed from latitudes, longitudes, and altitudes on the WGS-84 datum into latitudes, longitudes, and altitudes on the local datum. This operation is called a **datum transformation**.

Once the coordinates are expressed as latitudes and longitudes on the local datum, they must then be projected into North and East values on a flat grid, using an operation called a **map projection**. Finally, if altitudes are to be stored by the GIS, they need to be transformed from heights above the GRS-80 ellipsoid to heights above some other reference level. The most common reference level is the geoid, more commonly referred to as mean sea level. The TerraSync software and the GPS Pathfinder Office software both contain a geoid separation model which enables them to transform altitudes relative to GRS-80 into heights relative to mean sea level.

NOTE Data files are stored using the current coordinate system. If you change coordinate system, the current data file's coordinates are recalculated, which may take some time.

NOTE Each background image is associated permanently with a coordinate system. To display correctly when opened, a background image's coordinate system must match the current TerraSync coordinate system.



TIP

If no coordinate system has been assigned to an image when you open it in the background, TerraSync associates it with the current coordinate system. To change the coordinate system that is associated with a background image, change the image's coordinate system in the GPS Pathfinder Office software and transfer the image to TerraSync again. Alternatively, delete the corresponding .cs file in the TerraSync documents folder, change to the required coordinate system in TerraSync, and open the image in the Map background.

The geoid separation models used by the TerraSync software and the GPS Pathfinder Office software differ in accuracy. TerraSync is necessarily approximate, while GPS Pathfinder Office is more accurate. If you require altitudes relative to a different reference level, or relative to a more accurate (perhaps local) mean sea level model, you will need to process the heights in GPS Pathfinder Office before exporting them to your GIS.

The TerraSync software lets you specify a datum transformation and a map projection so that you can see your GPS position (and the position of features you may have recorded) in your local coordinate system. This makes it easy for you to check your position or navigate using a map produced by your GIS. It also lets you specify that heights will be shown relative to your local ellipsoid, or relative to mean sea level.



For your convenience, the TerraSync software hides the complexities of datum transformations and map projections behind the common names for the coordinate systems with which you may be familiar. Each named coordinate system has an associated datum (which encapsulates an ellipsoid) and a number of zones (each of which is a named instance of a particular map projection).



Coordinate systems available in the TerraSync software

The TerraSync software is supplied with a large number of coordinate systems and datums, including most National Coordinate Systems.

You can also create your own coordinate systems and sites using the Coordinate System Manager utility in GPS Pathfinder Office. You can easily load these coordinate systems into the TerraSync software using the Data Transfer utility.

NOTE The default geoid in the TerraSync software is the DMA 10x10 (Global) model. This is different from the default used by the GPS Pathfinder Office software. As a result, MSL heights in the TerraSync software may differ from those displayed in the GPS Pathfinder Office software.



Using the Coordinate System Manager utility

In GPS Pathfinder Office use the Coordinate System Manager utility to create and edit custom coordinate systems and sites for use with the TerraSync software. This data can be saved to a coordinate system export file, which you can then transfer to your field computer.

To use the Coordinate System Manager utility:

1. On the office computer, start the Coordinate System Manager utility from GPS Pathfinder Office.
2. Use the tabs in the main window to select or edit coordinate systems, zones, and sites.

WARNING When you transfer this file to your field computer, it will replace all coordinate systems already stored in the TerraSync software. Make sure you include all the coordinate systems you want to use in the TerraSync software in this new file.

3. Export the coordinate system database file. Select File / Export.
The Export dialog appears.
4. Select the Selected records only option in the Export dialog.



5. Click **OK**.

The Save As dialog appears.

6. Specify the filename and click **Save**.

When you have saved the coordinate system database files and the related support files, use the Data transfer utility to transfer the coordinate system export file to the TerraSync software. For more information, see **Transferring a coordinate system export file**.

For more information on using the Coordinate System Manager utility, refer to the GPS Pathfinder Office Help.



Transferring coordinate systems

There are two ways to transfer coordinate systems or sites to the TerraSync software. You can transfer a single coordinate system or site which you select at the time of transfer. Alternatively, you can use the Coordinate System Manager utility to create a coordinate system **export file** that contains a number of coordinate systems, zones, datums and sites, then transfer this file to the TerraSync software.

The TerraSync software stores all its coordinate systems in one file. When you load a new coordinate system into the TerraSync software, this **replaces** any existing coordinate system or systems in the software. If you transfer a single coordinate system or site, all existing systems in the software are lost. If you transfer a coordinate system export file, you can include any coordinate systems you want to keep, plus any new systems you want to transfer to the TerraSync software.

WARNING To prevent the loss of coordinate system information in the TerraSync software, Trimble strongly recommends that you transfer coordinate systems to your field computer in a coordinate system export file, rather than select a single coordinate system to send.

There are two procedures for transferring coordinate system data to the TerraSync software:

- **Transferring a coordinate system export file**
- **Transferring a single coordinate system**



Transferring a coordinate system export file

Use the Data Transfer utility to transfer a coordinate system export file, which can contain a number of coordinate systems and sites, to the TerraSync software.

To transfer a coordinate system export file:

1. Connect the field computer and office computer, start the Data Transfer utility, and connect to the appropriate device definition.

For detailed instructions on these steps, see [Transferring data](#).

2. Select the Send tab.
3. Click **Add** and select Coordinate System Export File from the drop-down list that appears.

The Open dialog appears, showing all coordinate system export (.cse and .csw) files in the default location for coordinate system files, C:\Program Files\Common Files\Trimble\Geodata.

4. Browse for the correct drive and folder if necessary, then select a .cse file and click **Open**.

NOTE You can select more than one .cse or .csw file to send, but each transferred file replaces any previously transferred files. Only the coordinate systems in the last file you transfer are loaded into the TerraSync software.



5. The Open dialog disappears. The coordinate system export file you selected is added to the Send list in the Data Transfer dialog.

6. Click **Transfer**.

If coordinate systems or sites in the selected export file reference other files such as geoid grid files, the Associated Files dialog appears.

7. Select the appropriate check box to send each file you require, then click **OK**.

The selected coordinate system export file and any associated files are transferred to the CE device, replacing any coordinate systems stored in the TerraSync software.

For more information, refer to the GPS Pathfinder Office Help.



Transferring a single coordinate system

Use the Data Transfer utility to transfer a single coordinate system to the TerraSync software.

To transfer a coordinate system:

1. Connect the field computer and office computer, start the Data Transfer utility, and connect to the appropriate device definition.

For detailed instructions on these steps, see **Transferring data**.

2. Select the Send tab.
3. Click **Add** and select Coordinate System from the drop-down list that appears.

The Coordinate System dialog appears:

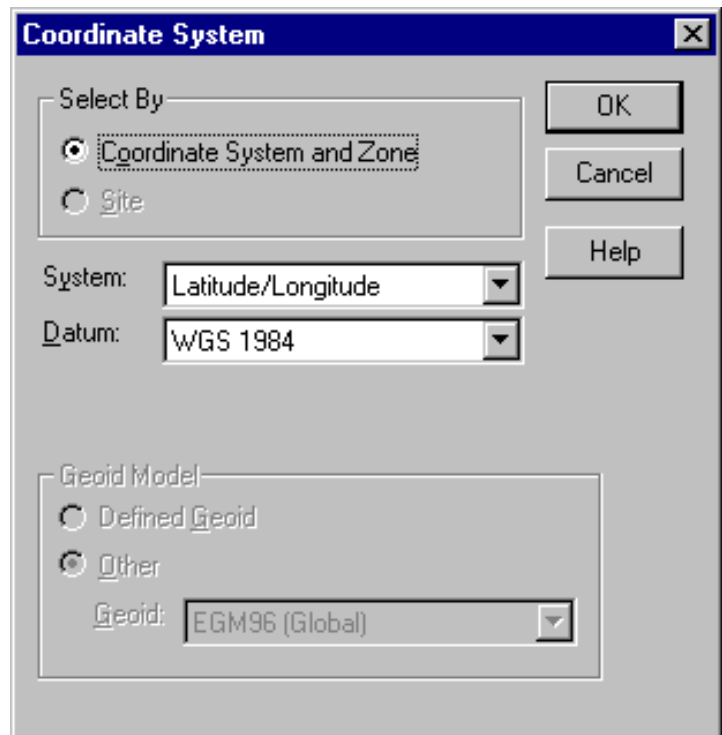

4. In the Select By group, select the appropriate option for sending a coordinate system or a site.
5. Select the options from the Site, System, Zone, and Datum fields that match the coordinate data you want to send. Some of these fields are read-only or hidden, depending on your selections in other fields.
6. Click **OK**.

The Coordinate System dialog disappears. The coordinate system or site you selected is added to the Send list in the Data Transfer dialog.

7. Click **Transfer**.

If the selected coordinate system references other files such as geoid grid files, the Associated Files dialog appears.

8. Select the appropriate check box to send each file you require, then click **OK**.

The selected coordinate system and associated files are transferred to the CE device, replacing any coordinate systems stored in the TerraSync software.

For more information, refer to the GPS Pathfinder Office Help.



Configuring coordinate systems

Setup / Coordinates

You can use the **Coordinate System** form to edit the coordinate system, zone, and datum parameters. The TerraSync software lets you specify a datum transformation and a map projection so that you can see your GPS position, and the position of features you collect, in your local coordinate system. This makes it easy for you to check your position or to navigate using a map produced by your GIS.

To configure the Coordinate System form:

1. Open **The Setup section**. Tap the Section button and select Setup from the drop-down list.
2. Tap **Coordinate System**.

The Coordinate System form appears:

3. Use this form to specify the coordinate system, site, zone, datum, and altitude reference. You can also specify the units used to display the coordinates and altitude.

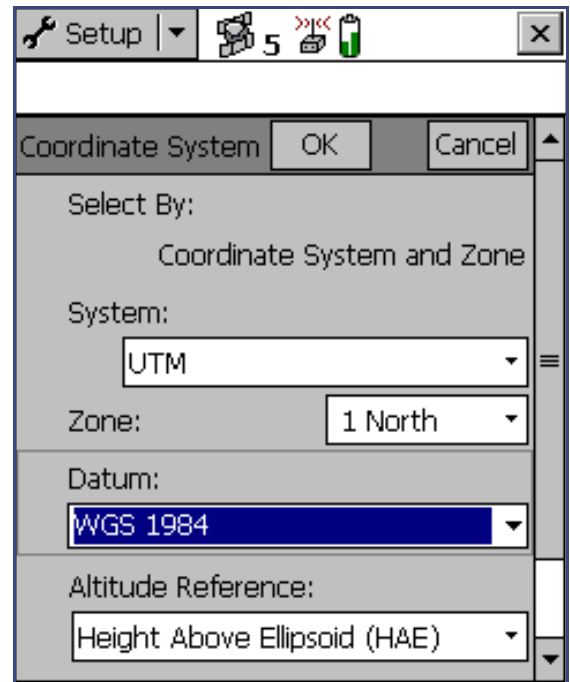

More...



4. Tap **OK** when you have finished.

The Coordinate System form closes and any changes you have made are applied immediately throughout the TerraSync software. If any points in the Map section are not within the coordinate system you select, TerraSync warns you and asks you to confirm that you want to apply the new coordinate system. If you do, the map points that are outside this system are not displayed on the map.

For more information, see **Coordinate System**.



REFERENCE

This Reference provides detailed information about screens that appear when you use the TerraSync software.

The first section in the Reference describes different ways to interact with the TerraSync software. It also explains how to use the keys and screens:

- **General operation**

The remaining five sections in the Reference describe the five sections of the TerraSync software:

- **The Map section**
- **The Data section**
- **The Navigation section**
- **The Status section**
- **The Setup section**



General operation

General operation contains detailed information about the TerraSync user interface and data entry methods. Topics are:

- **Authorization**
- **Getting help**
- **Windows operation**
- **Windows CE operation**
- **GeoExplorer CE handheld**
- **TSCe field device**
- **Starting and exiting the TerraSync software**
- **Section structure**
- **The TerraSync display**
- **Status bar**
- **Interacting with the TerraSync software**



Authorization

If you have a TSCe field device or GeoExplorer CE handheld with the TerraSync software pre-installed, you must license the software before you can use it. The first time you use TerraSync, the Authorization form appears:

Enter your name and organization, and the TerraSync version 2.20 serial number and authorization key that were provided with the field device. Then tap **OK** to continue. If the details you entered are correct, this screen will not appear again.

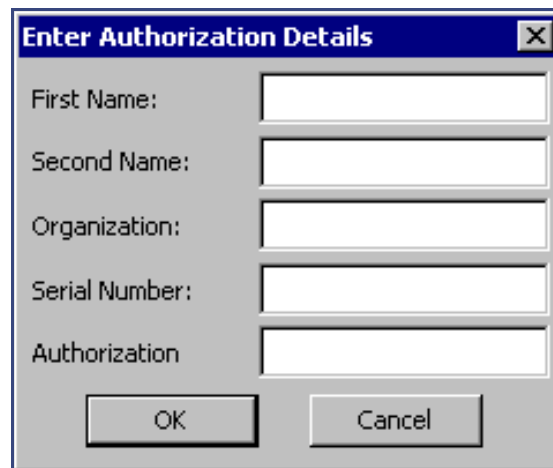

Getting help

Online help for TerraSync is displayed in HTML pages. It works in the same way as a Web page. You can select any blue underlined text to jump to the topic it describes.

Help is context-sensitive. If you access the Help while the TerraSync software is running, it opens at the topic that corresponds to the current TerraSync screen:

To access context-sensitive help from within the TerraSync software when using a PC, **H/PC Pro**, or **H/PC 2000**, tap .

To access context-sensitive help when using a **palm-size PC** or **Pocket PC**, tap  and select Help.

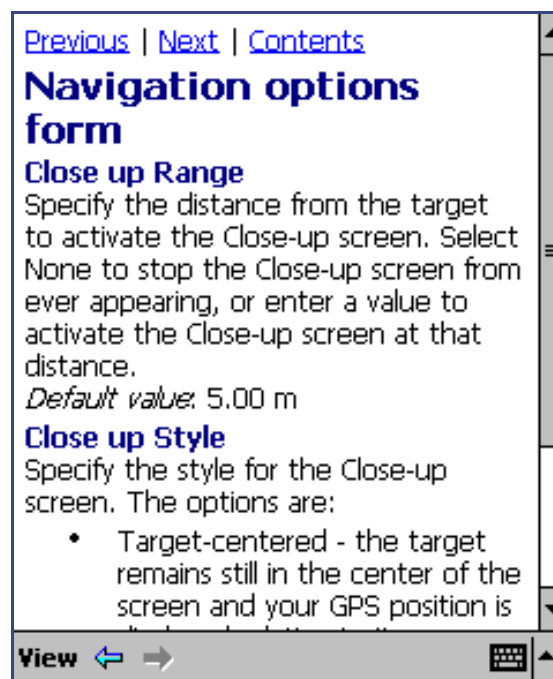

If you tap  and select Help on an H/PC Pro or H/PC 2000, or on a P/PC when the TerraSync software is not running, the main Help Contents topic appears. This topic lists all the help files available on your field computer. Select TerraSync to open the Contents topic of the TerraSync Help.

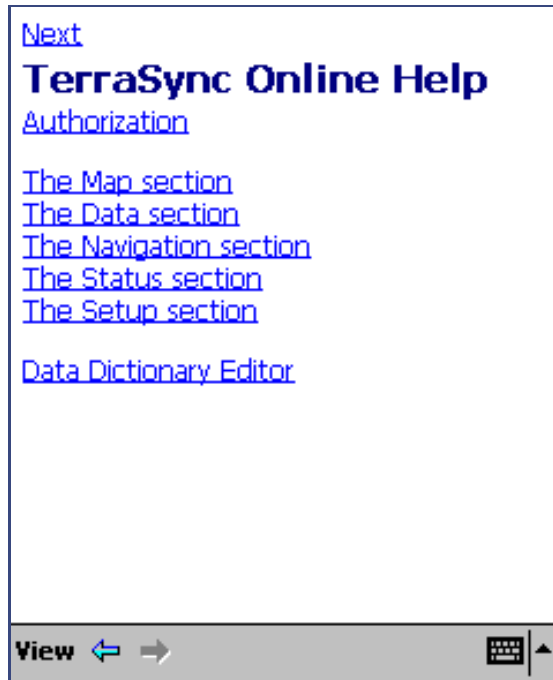

At any time while you are viewing help on a CE device, you can use the Contents command to return to the TerraSync Help contents, or the All Installed Help command to return to the main help menu for your CE device.

On a PC, you can use the Contents link to return to the TerraSync Help contents.

The TerraSync Help describes only the fields and commands for each screen. For detailed help, refer to the TerraSync Operation Guide (this document).



Windows operation

You can install the TerraSync software on a desktop or laptop PC instead of a CE device. This manual assumes that you are familiar with the Windows operating system installed on the PC.

This manual describes the TerraSync software as it appears on a portrait orientation **Pocket PC** with a 240 × 320 resolution screen. On a PC, some elements of the software are displayed differently. The main difference is that on a larger screen the TerraSync display is arranged in panes, so you can view up to three sections at the same time. For more information, see **Panes**. However, the CE device and PC displays function in the same way.

Except where specified, any information in this manual that relates to using TerraSync on a CE device also applies to operation on a PC.



Windows CE operation

This manual assumes that you are reasonably familiar with the Windows CE operating system. If you have used a Windows operating system such as Windows 98 or 2000, you will know how to use most Windows CE features. For help on Windows CE operation, select Help from the  menu on your CE device.

This section contains information about some Windows CE features that are essential to the TerraSync software:

- **Changing memory allocation**
- **Adjusting the screen contrast**
- **Working with other applications**
- **On-screen keyboards**
- **Device Lock utility**



Changing memory allocation

A CE device has a relatively small amount of random access memory (RAM), which is divided between **storage memory** and **program memory**. You can adjust the amount of available memory that is allocated to each of these two tasks.

Storage memory, like a hard disk on a desktop computer, is used to store files on the CE device. If you do not have enough space on your CE device, you can increase the storage memory to provide space for more files.

Program memory is used to run programs. If your programs are running slowly or the CE device displays messages warning you that program memory is low, you can increase the program memory.

TIP You should check the slider position regularly, to ensure that your memory allocations are appropriate. Normally, you should allocate as much program memory as possible. For example, if you delete files from the CE device or transfer them to the GPS Pathfinder Office software, you should convert the free space to program memory, to optimize the performance of the programs you are running. As you collect more data, you should check that there is sufficient storage space allocated, and increase it if necessary.

NOTE You can only change the allocation of memory that is not currently in use.

[More...](#)



To adjust the memory allocation:

1. On the Windows CE taskbar, tap .
2. Do one of the following:
 - On a Pocket PC, select Settings / System.
 - On an H/PC Pro or H/PC 2000, select Settings / Control Panel / System.
3. Select the Memory tab.
4. Drag the slider to the left to increase program memory, or to the right to increase storage memory.
5. Tap **OK** to close the System Properties dialog.

TIP For information on changing memory allocation on the TSCe field device, see [Using the TSCe field device](#).

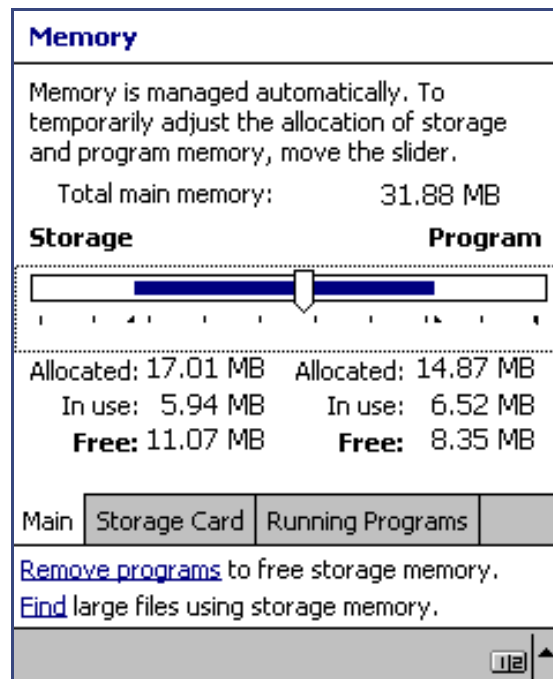

Adjusting the screen contrast

You can change the screen contrast on any CE device, to adjust to indoor or outdoor operation, in bright or dim light. Many CE devices have settings software and a hardware control for adjusting the contrast. For information on changing device settings, or on locating and using hardware controls, refer to the documentation for your CE device.

TIP For information on adjusting the screen contrast on the TSCe field device, see [Using the TSCe field device](#). For information on adjusting the screen contrast on a GeoExplorer CE handheld, see [Using the GeoExplorer CE handheld](#).



Working with other applications

Most programs that run on Pocket PCs do not have a close button or a menu command for exiting the program. Instead, you must use system software to shut down a particular program. If your CE device does not have a keyboard, you must use system software to switch from the active application to another application.

Tapping  / Programs / TerraSync when the TerraSync software is already running does not start the software a second time. Instead, the copy of the TerraSync software that is already open becomes the active program. You can use this method to switch back to the TerraSync software from another application.

TIP Some CE devices have hardware buttons that start specific applications. Often you can change the program that is assigned to a particular button, or delete any existing program assignment so that pressing the button has no effect. Removing or changing hardware button assignments can be helpful if you frequently activate hardware buttons by accident.



To shut down or switch to a task that is running on a Pocket PC:

1. On the Windows CE taskbar, tap .
2. Select Settings / System.
3. Select the Task Manager tab.
4. Highlight the task you want, then do one of the following:
 - To shut down the task, tap **End Task**.
 - To switch to the selected task, tap **Switch To**.
5. Tap **OK** to close the System Properties dialog.

TIP For information on using other applications on the TSCe field device, see [Using the TSCe field device](#).



On-screen keyboards

Some CE devices, such as the **Pocket PC** (P/PC), do not have a physical keyboard. Instead, you can use an **on-screen keyboard** to enter text. To activate an on-screen keyboard, tap the keyboard button in the taskbar. The currently selected on-screen keyboard pops up and partially covers any screen that is open. When you have finished entering text in a field, tap Enter to accept the text you have entered and move to the next field. To hide the on-screen keyboard, press the keyboard button on the taskbar again.

An on-screen keyboard usually consists of rows of “keys”. The default keyboard shows alphabetic or alphanumeric keys, laid out like a real keyboard. As you tap each key, the corresponding character is added to the current text or numeric field in the current program.

Alternatively, an on-screen keyboard may use **character recognition**. Normally, when using a character recognition keyboard, you draw text characters with your stylus in a special field. As you draw each shape, it is translated into the corresponding character and entered into the current field. You can correct any text that is incorrectly interpreted.

You can install different on-screen keyboards on your CE device and switch between them as required. For example, you may want to use a character recognition keyboard to quickly enter a long note, an alphabetic keyboard to enter a filename, and the Trimble numeric keyboard to enter numeric data such as the height of a feature or a distance.

TIP The keyboard button on the taskbar shows the icon of the currently selected on-screen keyboard.

More...



Options...

Character Recognizer
Keyboard

• Trimble Numeric Keyboard

TerraSync 12:13p

To change the selected keyboard, tap the arrow on the right end of the on-screen keyboard button. A list of installed keyboards pops up. The currently selected keyboard is indicated by a bullet. Tap the name of the keyboard you require to select it. The pop-up list closes automatically.

You can install various on-screen keyboards on your CE device, depending on your needs. All of these keyboards are available when you use the TerraSync software. The **Trimble numeric keyboard** is provided with the TerraSync software for easier entry of numeric information.

If your CE device has on-screen keyboards installed, the TerraSync software automatically displays the appropriate keyboard when you select a field that accepts data entry, and hides the keyboard when you select a control that does not accept keyboard input.



Trimble numeric keyboard

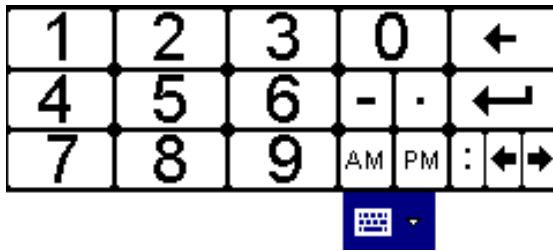

When you install the TerraSync software on a CE device that uses on-screen keyboards, the Trimble numeric keyboard is also installed. This keyboard contains numeric and symbol keys that are useful during numeric data entry and entry of time information.

This keyboard is available to other programs on your CE device as well as to the TerraSync software.

NOTE The Trimble numeric keyboard is only available on CE devices that use on-screen keyboards, such as the Pocket PC.



Device Lock utility

The Device Lock utility is installed with TerraSync on a CE device. It lets you lock the CE device so that accidentally pressing the screen, keys, or hardware buttons has no effect. Locking the CE device lets you safely clean the screen or exterior of the CE device, or transport or carry it.

To run the Device Lock utility, tap  / Programs /Device Lock. The following screen appears:

Once the device is locked, its screen, hardware buttons (including Record and Power buttons), and keypad, if it has one, do not respond until the device is unlocked.

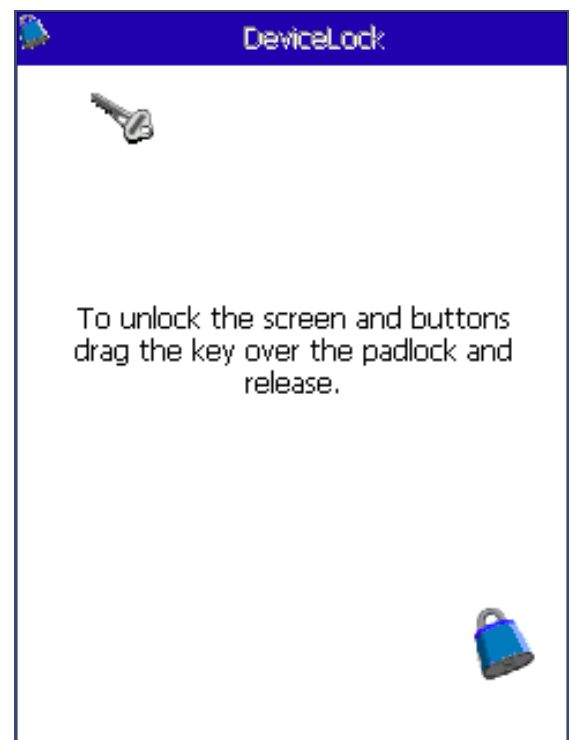

More...



Communication with external devices such as a GPS receiver, or external sensors used by TerraSync, is not interrupted by locking the device. This means that you can keep using TerraSync when the CE device is locked. For example, you may want to lock the CE device so that you can safely transport it in your pocket between features, but keep TerraSync connected to the GPS receiver so that you can collect a continuous block of carrier phase data.

To unlock the device, use a stylus or your finger to drag the key icon onto the padlock icon.



GeoExplorer CE handheld

The GPS CE handhelds in Trimble's GeoExplorer[®] CE series are combined GPS receivers and CE devices. They are **handheld PC 2000** CE devices that run version 3.0 of the Windows CE operating system. The GeoExplorer CE series includes the GeoXT[™] and GeoXM[™] GPS CE handhelds. Depending on the system you have purchased, your GeoExplorer CE series handhelds may be supplied with TerraSync pre-installed.

The GeoExplorer CE handheld has two types of memory, which are similar to the RAM and hard disk in a desktop PC.

The **main memory** (RAM) is used mainly for running programs, but it also stores essential files for the Windows CE operating system. The main memory is a volatile memory store, so it is cleared if the handheld loses power or is reset. However, you can back up the main memory to avoid data loss. For more information, see **Backing up data**.



touch buttons

Display button Power button

More...



NOTE In the TerraSync software and documentation, the term **RAM** is used to refer to the main memory on the GeoExplorer CE handheld.

The **Disk** is like a PC's hard disk. It is used for storing programs and data. The Disk is non-volatile flash memory, so it is not affected by power losses or resetting.

- **Using GPS**
- **Connecting to ActiveSync**
- **Using the GeoExplorer CE handheld**
- **Installing software on the GeoExplorer CE handheld**



Using GPS

Most GPS applications, including TerraSync, physically connect to an external GPS receiver on a COM port. On a GeoExplorer CE handheld, the GPS receiver is integrated with the CE device, so you do not have to make any physical connection. To use GPS from the GeoExplorer CE handheld's integrated GPS receiver, you connect using a **virtual** COM port. To the GPS application, connecting to a virtual COM port is exactly the same as connecting to a physical COM port.

By default, TerraSync is configured to connect to the correct virtual COM port (COM 3). When you run TerraSync for the first time on a GeoExplorer CE handheld, it automatically activates the GPS receiver.

To connect to the GPS receiver from any other GPS application, you must select the virtual COM port that corresponds with the GPS protocol that the application uses. If the application accepts NMEA messages from the GPS receiver, connect to COM2. If it uses TSIP messages, connect to COM3. All Trimble applications use TSIP messages to communicate with Trimble GPS receivers.

When TerraSync is installed on a GeoExplorer CE handheld, it becomes the handheld's default GPS status application, and is associated with the F1 GPS touch button on the screen. To run TerraSync, you can either tap  / Programs / TerraSync, or you can simply tap the F1 GPS touch button. For more information on touch buttons, refer to the GeoExplorer CE Series Getting Started Guide.



Connecting to ActiveSync

When the GeoExplorer CE handheld is physically connected to the desktop computer, it usually initiates connection automatically. To force the GeoExplorer CE handheld to re-initiate connection, remove it from the support module and then replace it in the support module. You can also manually initiate connection to the desktop. On the Windows CE taskbar, tap  and then select Programs / Communications / Connect to Desktop.

NOTE The GeoExplorer CE handheld should connect to ActiveSync using a **guest** relationship, not a partnership.

For more information on configuring ports and using ActiveSync, refer to your ActiveSync documentation.

For detailed troubleshooting information, see **ActiveSync does not connect to the CE device**.



Using the GeoExplorer CE handheld

This section contains information about some Windows CE features that are essential to using the TerraSync software on the GeoExplorer CE handheld:

- **Adjusting the screen display and calibration**
- **Changing the speaker volume**
- **Backing up data**
- **Resetting**
- **Clearing the main memory**
- **Working with other applications on the GeoExplorer CE handheld**



Adjusting the screen display and calibration

The touch screen is designed to be visible in all light conditions from night viewing to bright sunlight. If necessary, adjust the touch screen display and calibration:

- To turn the backlight on or off, press the Display button. When the backlight is on, its icon appears in the system tray.
- To adjust the screen contrast, hold down the Display button until the required contrast setting is reached. To fine-tune contrast, tap the Increase Contrast or Decrease Contrast touch button.
- The touch screen's calibration determines how sensitive it is to stylus taps. If the default calibration is not accurate, recalibrate the touch screen. Press both the Display button and the Power button to start the recalibration sequence, then follow the instructions on the screen.



Changing the speaker volume

To adjust the speaker volume:

1. Do one of the following:
 - Tap the F3 touch button.
 - On the Windows CE taskbar, tap  , and then select Settings / Control Panel / Volume & Sounds.
2. The Volume & Sounds Properties dialog appears. Make sure that the Volume tab is selected.
3. Drag the slider upwards to increase the volume, or downwards to decrease the volume.

TIP

You can also use this dialog to turn individual system sounds on or off.

4. Tap **OK** to close the System Properties dialog.



Backing up data

Because the main memory is volatile, you can lose data if the GeoExplorer CE handheld loses power or is reset. The GeoExplorer CE handheld features a main memory backup to the Disk. You can back up the main memory whenever you want.

To back up the main memory:

1. On the Windows CE taskbar, tap  Start .
2. Select Programs / Utilities / Back Up Main Memory.

After a temporary power loss or a reset, the main memory is restored automatically from the last backup. You cannot manually restore the main memory from this backup, except by **Resetting**.

The Disk is non-volatile memory, so documents and program files that are stored on the Disk are not affected by power loss or resetting. However, you can still lose data by accidentally deleting or overwriting it, or if the Disk malfunctions.

TIP To protect your data, Trimble recommends that you install software to the Disk and use ActiveSync to regularly back up the Disk contents onto your desktop computer.



Resetting

If your GeoExplorer CE handheld stops responding to the stylus, or the screen goes blank, you may need to reset it. When you reset your GeoExplorer CE handheld, or it loses power temporarily, the main memory is cleared and then restored from the backup on the Disk. Data that is stored on the Disk is not affected by a reset, but you will lose any unsaved data (for example, any unsaved changes to documents) and any data in the main memory that has changed since the last main memory backup.

To reset your GeoExplorer CE handheld:

- If the screen is not blank but does not respond to stylus taps, hold down the Power button until the screen goes blank (about 5 seconds).
- If the screen is blank:
 - a. Increase the contrast to check whether low contrast is the cause.
 - b. If increasing the contrast has no effect, hold down the Power button for 15 seconds.



Clearing the main memory

If resetting does not solve your problem, you may need to clear the main memory. Clearing the memory returns the main memory to factory defaults. All programs and files stored in the main memory are deleted and must be reinstalled. Programs and files stored on the Disk are *not* affected by clearing the main memory.

To clear the main memory:

1. Tap  / Programs / Utilities / Clear Main Memory.
2. A message appears asking you to confirm that you want to clear the main memory. Tap **Continue**.
3. A second message appears, asking you to confirm that you want to continue. Hold down the Display button and press the Power button to continue.



Working with other applications on the GeoExplorer CE handheld

Using Windows CE on a GeoExplorer CE handheld is very similar to working with a desktop Windows operating system.

- To shut down a program, tap the Close button in the top right corner of the program window.
- To switch to a program that is already running, tap the program's button on the Windows CE taskbar.

TIP

Tapping  / Programs / TerraSync when the TerraSync software is already running does not start the software a second time. Instead, the copy of TerraSync that is already open becomes the active program. You can use this method to switch back to the TerraSync software from another application.



Installing software on the GeoExplorer CE handheld

To install software, you must connect the GeoExplorer CE handheld to a desktop computer that has ActiveSync installed. Once an ActiveSync connection has been established, run the setup program on the desktop computer and follow the instructions on the screen to install the software.

TIP To protect your data, Trimble recommends that you install software to the Disk. TerraSync is always installed to the Disk on a GeoExplorer CE handheld.

NOTE You can only install software on your GeoExplorer CE handheld that is designed for an H/PC 2000 device with a StrongARM processor.



TSCe field device

Trimble's GIS TSCe™ field device is a **handheld PC 2000 CE** device that runs version 3.0 of the Windows CE operating system. The TSCe is supplied with either the TerraSync software or the Trimble Survey Controller™ software installed.

The TSCe has two memory locations: RAM (the default memory location on the device) and the internal storage card (a secondary storage location). RAM is a volatile memory store that is cleared if power is lost, or a hard reset is performed on the CE device. The storage card is non-volatile memory, so these events do not affect programs and data stored on the storage card.

NOTE In the TerraSync software and documentation, the term **Disk** is used to refer to the internal storage card on the TSCe.

- **Connecting to ActiveSync**
- **Using the TSCe field device**
- **RAM backup**
- **Installing software on the TSCe**



Connecting to ActiveSync

When the TSCe is physically connected to the desktop computer, it usually initiates connection automatically. To force the TSCe to re-initiate connection, unplug its data cable and then plug it in again. You can also manually initiate connection to the desktop. On the Windows CE taskbar, tap  and then select Programs / Communication / Connect to desktop.

You can use the Get Connected command in ActiveSync to initiate connection from the desktop computer. However, if the TSCe is trying to connect at the same time, this can prevent successful connection.

Connection to the desktop computer can be affected by other applications or devices trying to use the same port. Make sure that ActiveSync is monitoring the correct port, and that no other application or device is using the port on the computer. If possible, configure different COM ports for ActiveSync connection and connection to a GPS receiver or other device (for example, a laser rangefinder). If you cannot use a different port, disconnect from the GPS receiver or external device, or exit TerraSync, before connecting to ActiveSync.

NOTE The TSCe should connect to ActiveSync using a **guest** relationship, not a partnership.

For more information on configuring ports and using ActiveSync, refer to your ActiveSync documentation.

For detailed troubleshooting information, see **ActiveSync does not connect to the CE device**.



Using the TSCe field device

This section contains information about some Windows CE features that are essential to using the TerraSync software on the TSCe:

- **Changing memory allocation**
- **Adjusting the screen contrast**
- **Changing the speaker volume**
- **Using the keyboard instead of the touch screen**
- **Resetting**
- **Working with other applications on the TSCe**



Changing memory allocation

You can adjust the amount of available memory that is allocated to storage and to running programs. For more information on memory allocation and when to change it, see [Changing memory allocation](#).

To adjust the memory allocation:

1. On the Windows CE taskbar, tap , and then select Settings / Control Panel / System.
The System Properties dialog appears.
2. Select the Memory tab.
3. Drag the slider to the left to increase program memory, or to the right to increase storage memory.
4. Tap **OK** to close the System Properties dialog.



Adjusting the screen contrast

To adjust the screen contrast, hold down  and then hold down or repeatedly press  (decimal key) to lighten the display, or  (comma key) to make it darker.

Changing the speaker volume

To adjust the speaker volume:

1. On the Windows CE taskbar, tap , and then select Settings / Control Panel / Volume & Sounds.
2. The Volume & Sounds Properties dialog appears. Make sure that the Volume tab is selected.
3. Drag the slider upwards to increase the volume, or downwards to decrease the volume.

TIP You can also use this dialog to turn individual system sounds on or off.















4. Tap **OK** to close the System Properties dialog.



Using the keyboard instead of the touch screen

To control the TSCe field device, you can use either the keyboard or the touch screen. The following table shows some common actions that you can perform with the keyboard instead of the touch screen.

When more than one key is used to perform an action, you can press each key in sequence or press all keys at the same time.



To ...	press ...
access a drop-down menu	 and the letter key for the menu item
move between fields	
move between buttons	 ,  ,  , or  (arrow keys)
click the selected button	 (Enter key)
select a check box	 (Space key)
close a dialog without saving changes	
switch between programs	 
open the Task Manager	 
display the Start menu	 



Resetting

Occasionally you may need to reset your TSCe. There are two types of reset: a soft reset and a hard reset.

A **soft** reset is similar to restarting your desktop computer. It does not erase any data stored in RAM or on the storage card, but it ends any programs that are running, and you will lose any unsaved data.

To perform a soft reset of your TSCe, hold down the yellow  (Shift) key and . Then press  (Power). The TSCe shuts down any programs that are running, and then restarts in the default Windows CE desktop view.

A **hard** reset clears the contents of RAM, but does not affect the storage card. The TerraSync software and data files are stored on the storage card. However, the Help files, Asian font files, and some other files used by the TerraSync software are stored in RAM. Trimble recommends that you perform a **RAM backup** to protect these files against a hard reset or power failure.

To perform a hard reset, hold down  (Power) until the screen goes blank (about 10 seconds). The TSCe shuts down any programs that are running, briefly displays a boot screen, and then restarts in the default Windows CE desktop view.

A **full** hard reset clears the RAM and returns the TSCe to its factory default settings, deleting any software that you have installed. For information on performing a full hard reset of the TSCe, refer to the [Trimble website](#).



Working with other applications on the TSCe

Using Windows CE on an H/PC 2000 device, such as the TSCe, is very similar to working with a desktop Windows operating system.

To shut down a program, do one of the following:

- Tap the Close button in the top right corner of the program window.
- Press **Alt** and then **Tab** to display the Task Manager dialog, select the program from the list, and then click **End Task**.

To switch to a program that is already running, do one of the following:

- Tap the program's button on the Windows CE taskbar.
- Press **Alt** and then **Tab** to display the Task Manager dialog, select the program from the list, and then click **Switch To**.
- Press **Alt** and then **Esc** repeatedly to switch to each open program in turn.

TIP

Tapping  / Programs / TerraSync when the TerraSync software is already running does not start the software a second time. Instead, the copy of TerraSync that is already open becomes the active program. You can use this method to switch back to the TerraSync software from another application.



RAM backup

RAM backup is a data preservation feature that automatically backs up the contents of RAM to the non-volatile storage card. If the RAM is cleared by power loss or a hard reset, its contents are automatically restored from the RAM backup information stored on the storage card.

NOTE If you want to permanently delete the contents of RAM, delete the RAM backup store, and then perform a hard reset. This may delete some system files, which affects programs that are run from the storage card.

NOTE TerraSync data files are stored in the same place as the TerraSync software. When TerraSync is installed to the storage card, the term “Device” used in the TerraSync software refers to the storage card memory.

The TerraSync software and data files are stored on the storage card. However, the Help files, Asian font files, and some other files used by the TerraSync software are stored in RAM. To protect the TerraSync software against power loss, perform a RAM backup after installation. By default, this occurs automatically the first time you power down the TSCe after installing TerraSync.



NOTE The TerraSync files stored in RAM do not change while you are using the software, so you only need to perform one RAM backup to protect TerraSync. However, to protect other programs or data stored in RAM, you may want to back up more frequently.

You can configure the RAM backup feature to perform a backup:

- Never
- Periodically, at set time intervals
- On command
- Every time you power down the TSCe

You can also control the size of the data store allocated to RAM backup.

To access RAM backup settings, tap  and then select Settings / Control Panel / RAM backup.



Installing software on the TSCe

The TSCe is usually supplied with the current version of the TerraSync software installed. However, you may need to install upgrades or translations of the TerraSync software, or to install TerraSync on a TSCe that was supplied with other Trimble software installed.

TIP To protect your data, Trimble recommends that you install software to the Disk. TerraSync is always installed to the Disk on a TSCe.

For detailed installation instructions, see [Installing TerraSync on a CE device](#).





Starting and exiting the TerraSync software

To start the TerraSync software, tap , select Programs, then select TerraSync. While the software is loading, a Trimble identification screen appears.

The software always opens at the Skyplot subsection of the Status section.

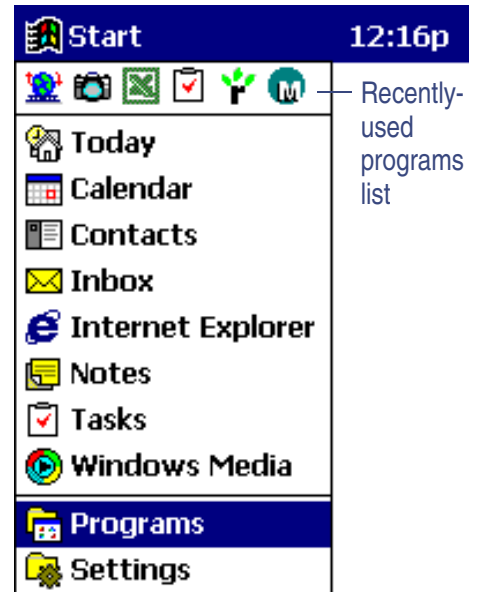
To exit the TerraSync software, tap the  button in the top right corner of any TerraSync screen. You do not have to exit the TerraSync software before powering off the CE device.







NOTE Tapping  / Programs / TerraSync when the TerraSync software is already running does not start the software a second time. Instead, the copy of the TerraSync software that is already open becomes the active program.

TIP To start or switch to TerraSync, you can also tap the TerraSync icon in the recently used programs list.



Section structure

The TerraSync software consists of five **sections**:

Use this section ...	to ...
 Map  Data	view features, background files, and the GPS trail graphically work with data files: <ul style="list-style-type: none"> • create a new data file or open an existing data file • collect new features or maintain existing features • move, copy, delete, or rename data and background files
 Navigation  Status	navigate to features using the Direction Dial and Close-up screen view information about: <ul style="list-style-type: none"> • the satellites the TerraSync software is tracking, their relative positions in the sky, and your current position • your GPS receiver and real-time correction source • the TerraSync software version and trademark information
 Setup	configure the TerraSync software



The TerraSync display



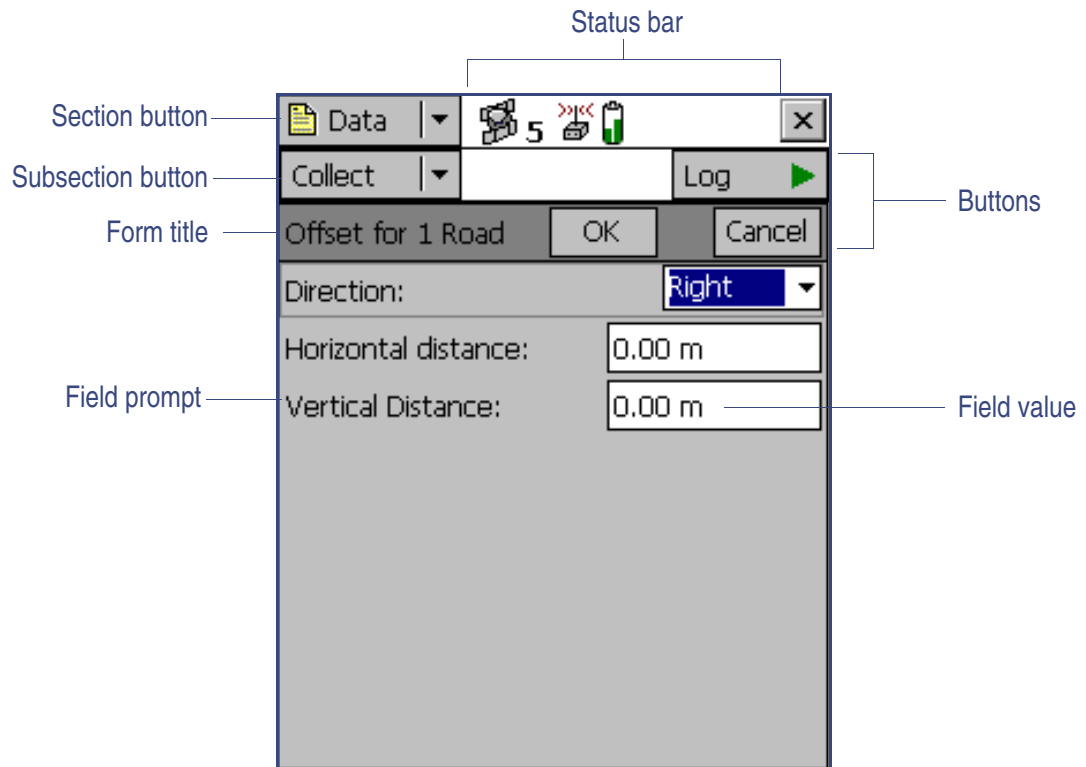

The screen below shows some of the features of the TerraSync software.

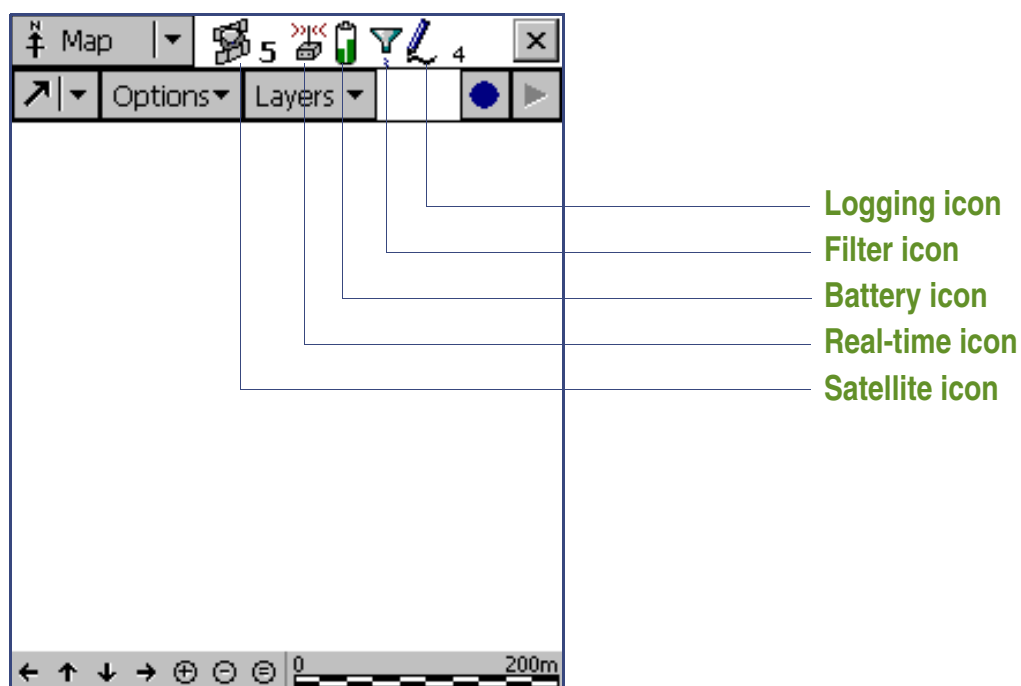

Status bar





The status bar appears in the top row of the TerraSync screen. It is always visible, but the icons displayed depend on the current status of the system. The status bar provides basic information about the status of the TerraSync software:



Icon	Name	Description
	Satellite icon	Shows whether the geometry of the satellites is good or bad, depending on the GPS configuration settings. The number below the icon indicates how many satellites are being used to compute GPS positions. The satellite icon flashes when the geometry of the satellites (their PDOP or HDOP) is poor. The number flashes when not enough satellites are available. You need at least four satellites to compute GPS positions.
	Satellite icon (carrier)	When you are logging carrier phase data, the satellite icon changes to show the carrier time, in minutes and seconds, for the current block of data.
	Connect icon	When the TerraSync software is trying to connect to a receiver, the connect icon appears instead of the satellite icon. If TerraSync cannot connect to the GPS receiver, the connect icon flashes.
	Antenna icon	If the TerraSync software connects to the receiver but cannot find a GPS antenna, the antenna icon appears instead of the satellite icon. This icon flashes to warn you that there is a problem. If no icon appears in this position, no GPS receiver is connected.



More...



Icon	Name	Description
	Real-time icon	Shows that the TerraSync software is receiving real-time corrections from an external source, such as a radio.
	Real-time BoB icon	Shows that the TerraSync software is receiving real-time corrections from a Beacon-on-a-Belt (BoB) receiver.
	Real-time beacon icon	Shows that the TerraSync software is receiving real-time corrections from a beacon.
	Real-time satellite icon	Shows that the TerraSync software is receiving real-time corrections from a satellite differential service.
	Real-time WAAS icon	Shows that the TerraSync software is receiving real-time corrections from the Wide Area Augmentation System (WAAS) satellite differential service. If the real-time signal is lost, the current real-time icon flashes. If no icon is visible, the TerraSync software is using autonomous GPS to calculate its position.





More...



Icon	Name	Description
	Battery icon	The left half of this icon indicates the charge level of the GPS receiver battery, if one is connected. The right half indicates the charge level of the field computer's battery. When the battery is fully charged, the corresponding half of the battery icon appears green . The level of green is lower when the battery charge is lower. When the power level is low, the level in the icon is yellow . When the power level is critical, the corresponding half of the icon is red and the icon flashes. NOTE A GeoExplorer [®] CE series GPS CE handheld is a combined GPS receiver and CE device, and both components use the same battery. When TerraSync is running on a GeoExplorer CE handheld , both halves of the battery icon show the same level.
	Filter icon	Indicates that a filter has been applied to the open data file. When this icon is not displayed, no filter has been set up. For more information, see Filtering features .
	Logging icon	Shows that the TerraSync software is logging GPS position information. The number to the right of the icon indicates the number of positions logged.

More...



Icon	Name	Description
	Logging carrier icon	Shows that the TerraSync software is logging carrier phase GPS position information. The number to the right of the icon indicates the number of positions logged.
	Logging vertex icon	Shows that the TerraSync software is logging GPS position information for an averaged vertex. The number to the right of the icon indicates the number of positions logged for this vertex.
	Digitizing icon	Shows that the TerraSync software is in Digitize mode and GPS logging is paused, so tapping the map will result in a digitized position being recorded for the open feature. The number to the right of the icon indicates the number of digitized positions logged for this feature.
	Pause icon	When logging is paused, the pause icon flashes.
	Memory icon	When storage space is low, the memory icon appears. If you are logging positions and memory gets low, the memory icon flashes alternately with the logging icon. If you are not logging, the memory icon appears alone and flashes. When no icon appears in this position, memory space is sufficient, and the TerraSync software is not logging position data.



ToolTips

If you tap any status icon, a ToolTip appears over it. The ToolTip contains information about the current state of the system function the icon represents.

For example, if you tap the **Filter icon** when a filter is in use, the ToolTip that appears is as shown:

To close a ToolTip, tap it, or tap anywhere else on the screen.

Transient messages also appear as ToolTips. A transient message shows information that is only important for a few seconds, such as notification that you have successfully recorded an offset with a laser rangefinder, or that the feature has been stored.

A ToolTip that contains a transient message appears over the status bar for three seconds, or until you tap the ToolTip. Other functions in the software are not affected by transient messages.

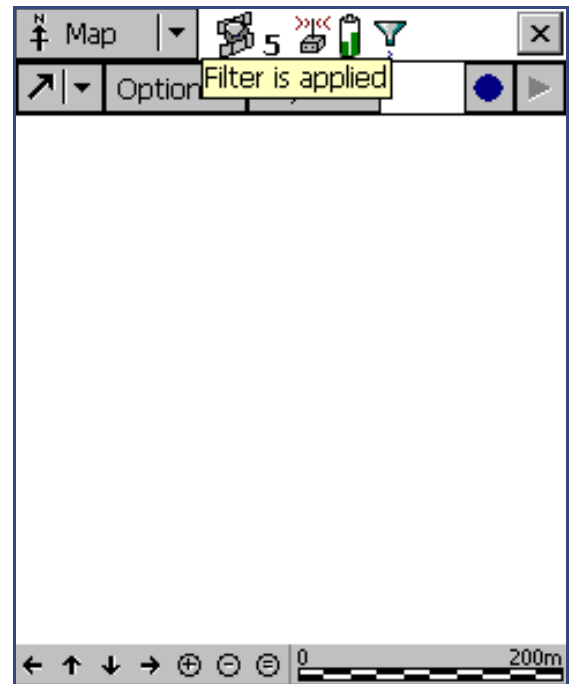







The following transient messages appear as ToolTips:

- Carrier lock lost
- Offset received
- Existing offset reset
- Vertex stored
- Feature stored
- Shape conversion complete
- Shape conversion failed
- Internet download complete
- Internet download failed
- Configuration loaded













The following table shows the status bar icons and the ToolTips that appear to describe them:

Icon	Behavior	ToolTip
	Solid	GPS is calculating positions
	Solid	GPS is calculating positions in carrier phase mode
	Flashing	Poor satellite geometry (PDOP) <i>or</i> Poor satellite geometry (HDOP) NOTE The message that appears depends on whether a maximum PDOP or HDOP value is configured.
	Flashing satellite count	Too few satellites
	Animated	Attempting to connect to GPS receiver
	Flashing	No GPS detected. Check cables and batteries.
	Flashing	Antenna is not connected to GPS receiver





More...









Icon	Behavior	ToolTip
	Solid	Applying real-time corrections from External Source
	Flashing	Waiting for real-time corrections
	Solid	Applying real-time corrections from BoB
	Flashing	Waiting for real-time corrections
	Solid	Applying real-time corrections from Integrated Beacon
	Flashing	Waiting for real-time corrections
	Solid	Applying real-time corrections from Integrated Satellite
	Flashing	Waiting for real-time corrections
	Solid	Applying real-time corrections from WAAS
	Flashing	Waiting for real-time corrections

More...



Icon	Behavior	ToolTip
	Solid	GPS receiver battery is good (75%) Field computer battery is good (75%)
	Solid	GPS receiver battery is low (25%) Field computer battery is low (25%)
	Flashing	GPS receiver battery is critical (10%) Field computer battery is critical (10%)
NOTE The icons and ToolTips above are examples, showing both batteries at the same level of charge. However, each half of the battery icon can appear in green, yellow, or red, independently of the color and level of the other half.		
	Solid	Filter is applied



Icon	Behavior	ToolTip
	Animated pen, and number increments	Positions are being logged
	Flashing pen	GPS is not available
	Animated pen, and number increments	Carrier positions are being logged
	Animated circle decreases in size	Vertex capture in progress
	Solid	Ready to digitize
	Flashing	Position logging is paused
	Flashing	Memory is full

TIP Tooltips also appear when you tap graphical elements in the **Skyplot**.



Interacting with the TerraSync software

You can interact with the TerraSync software in a variety of ways. The following topics describe the different types of displays:

- **Screens**
- **Graphical screens**
- **Forms**

The TerraSync software also uses the following features in its screens:

- **Lists**
- **List buttons**
- **Menu buttons**
- **Buttons**
- **Data entry**
- **Auto-incrementing attributes**
- **Pop-up messages**
- **Sound**
- **Color**

If your field computer has a keyboard, you can use keyboard shortcuts:

- **Keyboard shortcuts**



Screens

Use screens to view information in a list or table, or to make selections that provide access to other areas in the software. Screens usually display information that you cannot edit directly.

Most screens contain buttons, lists, or prompts. When a screen contains a field, the default value is supplied in the field.

Examples of screens are:

- The top level screen for each subsection in the Data section, such as the New File screen and the File Manager screen
- The main screen of the Setup section

Name	Start Time	Size
R111011A	11/10/00 11:07 am	2 KB
R121215A	12/12/00 03:11 pm	2 KB
Sample	11/24/00 01:17 pm	70 KB
Starfish	12/14/00 04:22 pm	5 KB

Features 145 Positions: 468
Status: Not Transferred DD: Seaview



Graphical screens

Use graphical screens to view information graphically. You cannot enter data in a graphical screen, and you cannot edit the information displayed.

Examples of graphical screens are:

- The Skyplot screen and Satellite Information table in the Status section
- The Direction Dial and Close-up screens in the Navigation section
- The map display in the Map section

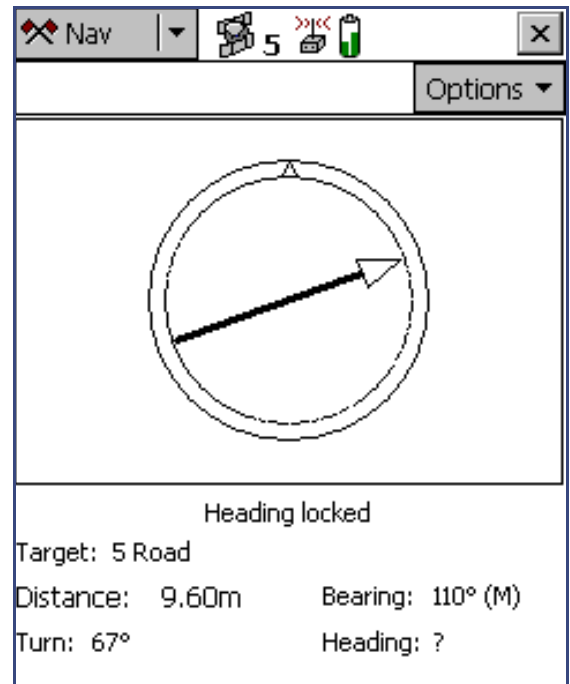

Forms

Data entry in the TerraSync software takes place in **forms**. These are like paper forms, in that they have a title and a sequence of lines or fields. Use a form to enter information.

Each field on a form generally has two parts, a prompt (or name) and a value. A prompt is followed by a colon (:), which separates it from the value. Some fields are separator fields, which have no value and serve simply to divide a form into sections.

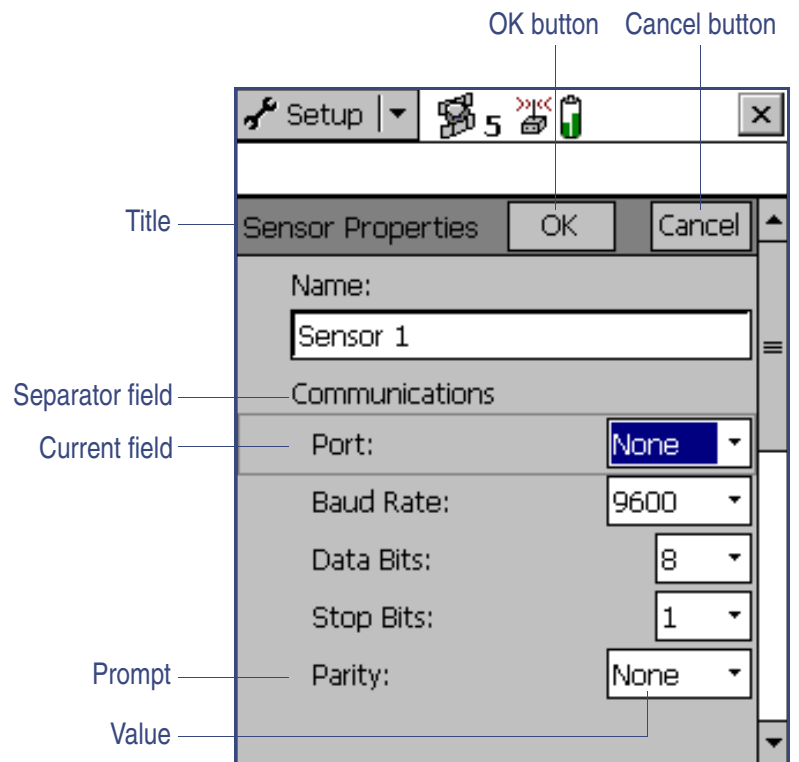

More...



One field in every form is the current field. It is distinguished by a dark rectangle around the prompt and field. Any editing operations on a form apply to the current field.

To edit a field, select it. There are several ways to enter data into a form, depending on the keyboard options your field computer has, and the type of data stored in the field. For more information, see [Data entry](#).

To move to the next field in a form, do one of the following:

- Tap the next field.
- Tap Enter on the on-screen keyboard. Tap Enter repeatedly to cycle through all fields on the form.
- Press Tab on the physical keyboard. Press Tab repeatedly to cycle through all fields on the form.

To move up or down the form, drag the vertical scroll bar.

When you have finished browsing through the form, or have finished editing fields in the form, tap **OK** to accept the changes you have made and return to the previous screen.



Lists

The TerraSync software provides **lists** for you to select data files or features from. A list contains the information that is currently stored.

Each row of the list represents one file or feature. Each column shows information about that item. A list also has a title that describes its contents.

This is the Choose Feature list, as shown in the title. This list displays all feature types in the open data file.

#	Name			Distance
1	Road Sign	<input checked="" type="checkbox"/>		42.77m
2	Road Sign	<input type="checkbox"/>		22.47m
3	Road	<input type="checkbox"/>		32.02m
4	Park	<input type="checkbox"/>		3.56m

Positions: 1
10/12/00
Speed Limit



Often information fields are displayed at the bottom of the screen, below the list. They provide useful information about the item currently highlighted in the list.

To select an item from a list, highlight the item. If the item you want is not visible, drag the vertical scroll bar up or down until it is visible.

You can tap a column heading to sort by that column. For example, to sort the Choose Feature list by feature name, tap the Name column heading.

TIP

If the list is already sorted by the column you tapped, tapping the column heading reverses the sort order.



List buttons

List buttons look like **Buttons**, except that at the right end of the button there is a vertical line followed by a drop-down arrow.

The following list buttons appear in the TerraSync software:

- Section button
- mini Section button (appears when the software is arranged in **Panes**)
- Subsection button
- Map Tools button in **The Map section**
- Status Mode button in **The Status section**

The screenshot shows a software interface with a top status bar containing 'Status', signal strength, a '5', a battery icon, and a close button. Below this is a list with a 'Real-time' section header and a 'Summary' sub-header. The list contains an 'Integrated Satellite' entry with details: 'Service Provider: OmniSTAR', 'Frequency: 1558.510 MHz', 'State: Lock', and 'SNR: 5.0'. A 'More...' button is visible at the bottom right of the list area. Callouts point to the 'Status' dropdown as the 'Section list button', the 'Real-time' dropdown as the 'Subsection list button', and the 'Summary' dropdown as the 'Status Mode list button'.

Use list buttons to move to a different section or subsection of the software, or to change the mode in the current section.

More...



When you tap a list button, a drop-down list appears. Select an option on the list to select the command it describes. The label of the list button changes to match the option you selected.

NOTE The **Options** button and the **Layers** button are menu buttons. They differ from list buttons in their appearance, behavior, and function. For more information, see **Menu buttons**.



Menu buttons

Menu buttons are similar in appearance to **Buttons**, but a menu button has a drop-down arrow at the right end of the button.

The following menu buttons appear in the TerraSync software:

- the **Layers** button in the Map section
- the **Edit** button in the Data section's **Edit dictionary form**
- any **Options** button

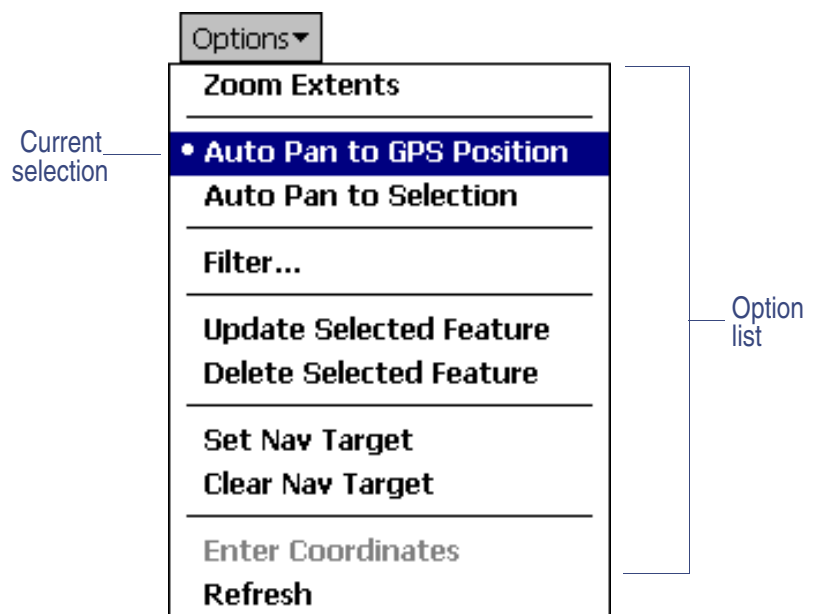

Use menu buttons to access additional functionality and commands. When you tap a menu button, a drop-down list appears. Select an option on the list to select the command it describes. Unlike a list button, a menu button's label does not change when you select a command from the list.

NOTE The Section, Subsection, Map Tools, and Status Mode buttons are list buttons. They differ from menu buttons in their appearance, behavior, and function. For more information, see **List buttons**.



Buttons

Many forms and screens in the TerraSync software contain buttons. When you tap a button, the TerraSync software carries out the appropriate command or opens a new screen. For example, if you tap **GPS Settings** in the Setup screen, the GPS Settings form appears.

NOTE Buttons that have an arrow on them and display a drop-down list when you tap them are either **List buttons** or **Menu buttons**.

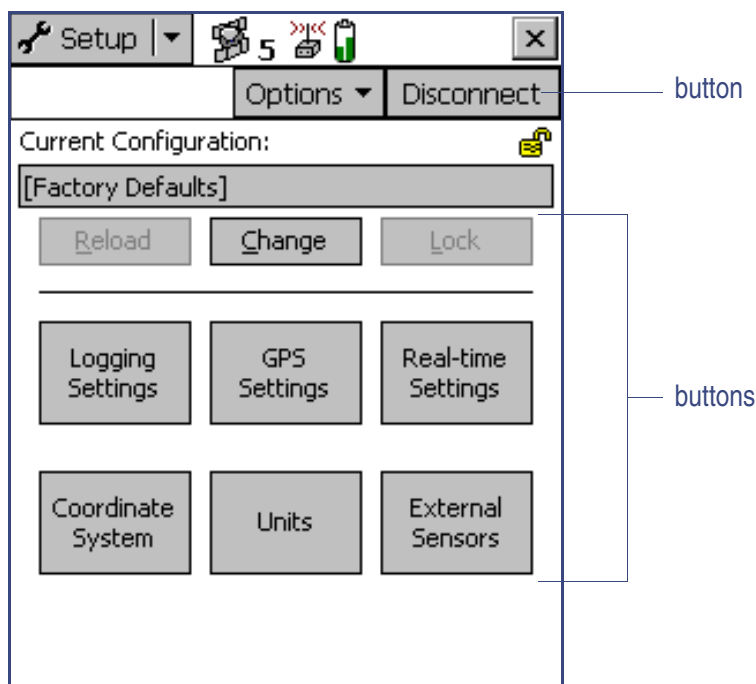

Keyboard shortcuts

If you are using a field computer that has a keyboard, such as a notebook computer or a TSCe field device, you can use keyboard shortcuts instead of the touch screen.

To use a keyboard shortcut, hold down the **Alt** key on the keyboard and press the letter assigned to the shortcut. For example, the shortcut letter for switching to the Map section is M, so pressing **Alt+M** switches to the Map section.

There are two types of shortcuts in the TerraSync software: global and local shortcuts.

Global shortcuts apply wherever you are in the software. They let you perform important actions such as switching quickly between the sections of the software. If you use the shortcut for the current section or subsection, the corresponding list drops down. For example, if you press **Alt+M** when the Map section is already open, the Section list drops down.

You can also use global shortcuts to close the current file, exit the software, or control data logging from any section or screen of the software.



The following table lists the global shortcuts in the TerraSync software:

Action	Keyboard shortcut
Open Map section	Alt+M
Open Data section	Alt+D
Open Navigation section	Alt+N
Open Status section	Alt+S
Open Setup section	Alt+E
Open Skyplot screen	Alt+K
Open New File subsection	Alt+T
Open Collect Features subsection	Alt+T
Open Update Features subsection	Alt+U
Start, pause, or resume logging GPS	Alt+L
Close current data file	Alt+C
Exit TerraSync	Alt+Q

NOTE Global shortcuts do not apply when the Data Dictionary Editor is open.



Local shortcuts apply only within the current form or screen. They open lists such as the Options list or subsection list, or run commands on the open list.

The same local shortcut letter may be used in different screens to perform different tasks. For example, pressing **D** when the Setup section's Option list is open disconnects from the GPS receiver, but pressing **D** in the File Manager subsection's Option list deletes the selected file.

If the field computer's screen size is 640 × 240 or larger, the screen is arranged in panes. Local shortcuts work only for the primary pane (the pane in the top left of the screen).

The following table lists the local shortcuts in the TerraSync software:

Action	Section	Keyboard shortcut
Select a command on an open list	All sections	underlined letter
Open the Options list for the current screen	All sections	Alt + O
Open the Layers list	Map	Alt + A
Zoom in	Map	Alt + Z
Zoom out	Map	Alt + Y
Zoom extents	Map	Alt + X
Move up	Map	Alt +up arrow key; Alt +8
Move down	Map	Alt +down arrow key; Alt +2
Move left	Map	Alt +left arrow key; Alt +4
Move right	Map	Alt +right arrow key; Alt +6

More...



Action	Section	Keyboard shortcut
Open Existing File subsection	Data	Alt + X
Open File Manager subsection	Data	Alt + G
Open Skyplot subsection	Status	Alt + K
Open Satellite Info subsection	Status	Alt + F
Open Receiver subsection	Status	Alt + V
Open Real-time subsection	Status	Alt + A
Open Plan subsection	Status	Alt + P
Open Sensor subsection	Status	Alt + R
Open Comms subsection	Status	Alt + O
Open UTC Time subsection	Status	Alt + I
Open About subsection	Status	Alt + B



Data entry

The method you use to enter data in a field on a form depends on the type of field you are entering data into, and the availability of keyboards.

A field on a form is one of the following types:

- **Text fields**
- **Numeric fields**
- **Menu fields**
- **Time fields**
- **Date fields**
- **Filename fields**

For each type of data, the TerraSync software offers different options for entering values.

If your field computer has a physical keyboard, you can use it to enter text or numbers, just as you would in any Windows program. If you do not have a keyboard, you can use on-screen keyboards for data entry. An on-screen keyboard is a small dialog that pops up from the taskbar when you select a field that allows data entry. You can also manually activate an on-screen keyboard at any time.



You use the on-screen keyboard to specify the text or number you want to enter. As you enter characters, they appear in the selected field. An on-screen keyboard may provide “keys” for you to tap, or may accept handwriting which it interprets as text.

If you use an on-screen keyboard to enter values, the TerraSync software automatically moves the focus to the next field in the form. You can cycle through the fields on a form by repeatedly tapping Enter on the on-screen keyboard. If you have a physical keyboard, cycle through the fields by pressing the Tab key. When you reach the end of the form, the focus moves to the first field in the form.

For more information, see **On-screen keyboards**.



Text fields

To enter a value in a text field, use an on-screen keyboard or the physical keyboard. If you are using a field computer with on-screen keyboards, a keyboard pops up automatically when you select a text field. The keyboard that pops up is the one that was selected when you started the TerraSync software.

Any text field can be defined as an auto-incrementing attribute. For more information, see [Auto-incrementing attributes](#).



Numeric fields

To enter a value in a numeric field, use an on-screen or physical keyboard. If your field computer uses on-screen keyboards, the [Trimble numeric keyboard](#) pops up when you select a numeric field.

Any numeric field can be defined as an auto-incrementing attribute. For more information, see [Auto-incrementing attributes](#).



Menu fields

A menu field has a predefined list of values associated with it. To change the selected value, tap the drop-down arrow at the right of the field and select an option from the list.

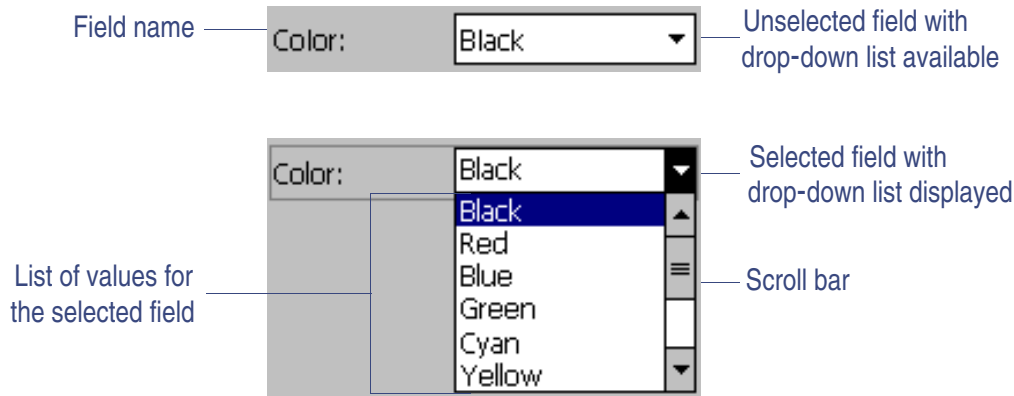

The current value in a drop-down list is highlighted. To choose a different value, select the value from the list. If a drop-down list has more options than fit on one screen, a scroll bar appears on the right. Drag the scroll bar or tap the arrow buttons to scroll up and down the list.

Some menu fields can store either a value you enter or a value you select from a list. For example, in the Data form in the Setup section, the Interval field can accept *either* an integer between 1 and 999, *or* Off. This field lets you enter a value manually using an on-screen or physical keyboard, but also includes a drop-down list of values.



Time fields

You can enter time values manually using an on-screen or physical keyboard, or you can select the current time from a drop-down list. If your field computer uses on-screen keyboards, the **Trimble numeric keyboard** pops up when you select a time field.

To enter the current time, tap the arrow at the right of the field and select Now from the drop-down list.

In the data dictionary, you can specify that a time attribute be automatically set to the current time when the feature is created, when the feature is updated, or both.



Date fields

You can enter a date value manually using the physical keyboard, or by selecting it from the drop-down calendar:

To enter a date manually, type it in from the keyboard. To select it from the calendar, tap the drop-down arrow at the right of the date field and select the date you require from the calendar.

In the data dictionary, you can specify that a date attribute be automatically set to the current date when the feature is created, when the feature is updated, or both.

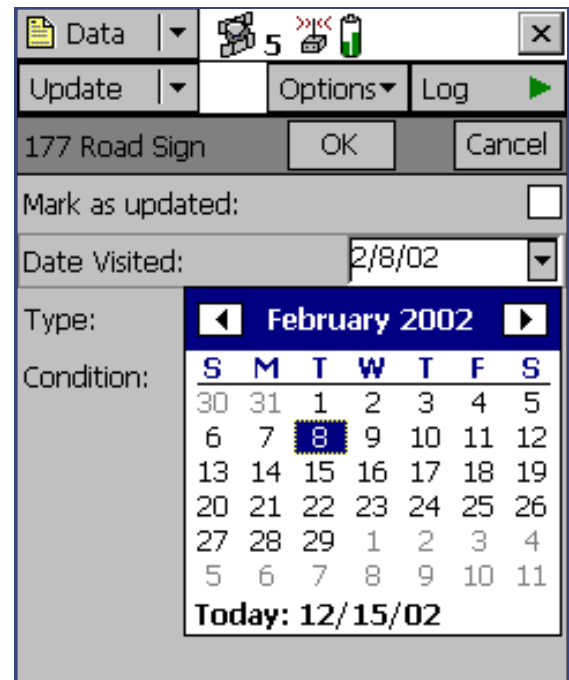

Filename fields

You can attach any file to a feature by storing its path and filename in a filename attribute.

The TerraSync software does not record attached files. Use other software or hardware, such as a digital camera or sound recorder, to create and save files before you attach them to features.

You can enter a filename value manually using the physical keyboard, or by selecting it from the drop-down list.

The drop-down list shows files in the current working folder. To change the working folder, tap the Browse button  to the right of the filename attribute field and in the pop-up window that appears, navigate to the folder you need.

TIP

If you set the working folder to the folder where the files to be attached are stored, you can simply select the appropriate file for each feature from the drop-down list, without having to check or change the working folder each time.

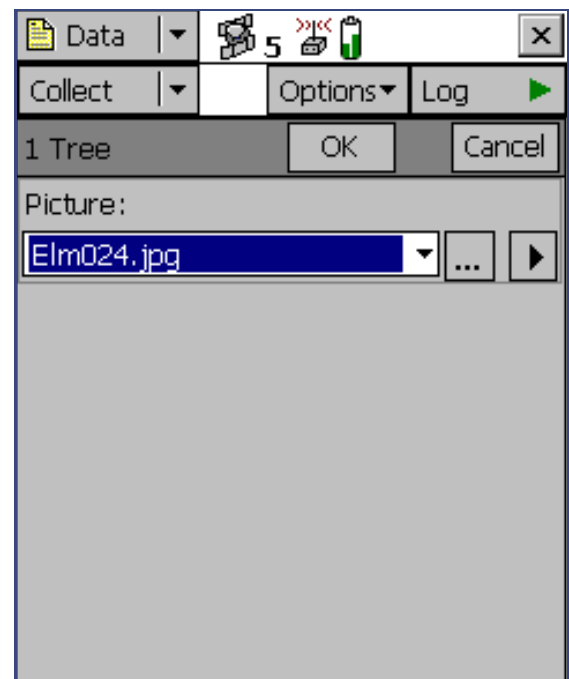

To view the currently selected file, tap the Preview button  beside the attribute field. The file is opened in the default program associated with its file type.

Once you attach a file to a filename attribute in a feature and save the feature, the selected file is moved to the TerraSync data folder and assigned a unique name. Because the file is renamed, the actual filename is not displayed if you open the feature for review later. Instead, a message based on the file type appears. For example, if you attached the file Elm024.jpg to a feature, when you return to the feature later the text **Attached JPG File** appears in the attribute field.

When you transfer the data file to your office computer using the Data Transfer utility, any attached files are transferred with the data file, and are stored with the transferred data file. This link is also maintained when you export the data file to a GIS. For more information, refer to the GPS Pathfinder Office Help.

TIP Sometimes, to save space or to create better quality files, software on a CE device (such as sound recording software that creates .wav files) uses a default file format that is unreadable on a desktop computer. Before going out into the field, test that you can transfer and read files created by the software that you want to use. If necessary, change the recording software's settings to use a format that is compatible with your desktop computer.



Auto-incrementing attributes

Any numeric or text attribute belonging to a feature can be defined as an auto-incrementing attribute. When you create a new feature, the TerraSync software automatically fills in any auto-incrementing attributes with the next value in the sequence, based on the step value you specify in the data dictionary and the last value entered in the field. The sequence can increase or decrease, and may advance in any increment (step) value, provided this value is within the acceptable range for the attribute.

Although you can define a text attribute as an auto-incrementing attribute, only numeric values within the text are incremented or decremented. For example, if the last value you entered was 47A, and the step value is 1, the next value generated by the TerraSync software is 48A. However, if the last value was AAA, the next is still AAA, as there is no numeric component to increment.

When the text consists of more than one number interspersed with alphabetic characters, only the last number is incremented. For example, if the last value was A100-K9, the last number (9) is extracted, incremented to 10 (with a step value of 1), and replaced in the string to generate the text A100-K10.

As with any other default value, you can edit an auto-incremented value. However, if you edit an auto-incremented value, the next value in the sequence is calculated using the new value you entered, not the original value generated by the system.

[More...](#)



If any condition prevents the system from generating the next value in the sequence, the attribute is created without any value. This occurs when:

- the feature is the first of its type to be created in this file and no default value is specified
- the last value for the attribute was blank
- the last value was the maximum value in the range and the sequence is incrementing
- the last value was the minimum value in the range and the sequence is decrementing

To make an attribute auto-incrementing, you must set an increment value in the data dictionary. You can do this in the Data Dictionary Editor utility in the GPS Pathfinder Office software, or in the Data section's **File Manager** subsection. For more information on making an attribute auto-incrementing, refer to the Data Dictionary Editor Help.



Pop-up messages

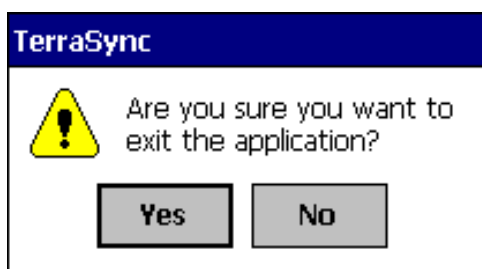

Occasionally, a message “pops up”. When the TerraSync software asks a question, a message pops up with two buttons, one of which you tap in response. To do this, tap the button you want.

Error messages are examples of pop-up messages. **Warning** and **Error** messages should be noted, because they contain important information about the task you are trying to perform.



Sound

The TerraSync software uses sound to indicate special conditions. Often these conditions are accompanied by a change in a status icon. For example, when the battery on your GPS receiver gets low, the battery icon in the **Status bar** flashes, and the **Low GPS battery** sound is played.

The sounds used in the TerraSync software fall into three categories:

Category	Description
Success	An operation has been successfully completed, or a warning condition has been resolved. By default, a success event uses a sound with rising tones.
Warning	A condition exists that could cause loss of data, or could prevent you from collecting data successfully. By default, a warning is indicated by a sound with falling tones.
System	A message box, containing a question or information about an error that has occurred, has appeared. You must acknowledge the message, by tapping a button in the message box, before you can continue working with the TerraSync software.

The TerraSync software is supplied with default sounds for all warning and success events. However, you can customize these sounds or disable any or all of the sounds played by the software. For more information, see **Customizing sounds**.

[More...](#)



The TerraSync software plays the following sounds:

- **Feature stored**
- **Minimum positions stored**
- **Real time OK**
- **Poor geometry**
- **General error**
- **GPS connected**
- **Navigation proximity alarm**
- **Dead GPS battery**
- **Real time lost**
- **Question**
- **GPS OK**
- **Position logged**
- **Low GPS battery**
- **Too few satellites**

Name	Type	Description
Feature stored	Success	The feature has been successfully stored.
GPS connected	Success	The TerraSync software has successfully connected to your GPS receiver and is receiving position information.
GPS OK	Success	The GPS quality has increased to the levels you have specified, and the TerraSync software is logging positions again.

[More...](#)



Name	Type	Description
Minimum positions stored	Success	The TerraSync software has logged the minimum number of positions for the current feature. You can now safely close this feature and begin logging another feature.
Navigation proximity alarm	Success	The navigation target is within the close-up range you have specified, and the Direction Dial screen changes to the Close-up screen.
Position logged	Success	The TerraSync software has successfully logged a GPS position.
Real time OK	Success	The connection to the specified source of real-time differential correction has been regained.
Dead GPS battery	Warning	The battery in use by your GPS receiver is dead. The TerraSync software continues to operate but no position information is received until the battery is replaced.
Low GPS battery	Warning	This sound plays repeatedly and the battery icon in the status bar flashes when the battery in use by your GPS receiver is running low and needs to be replaced.

More...



Name	Type	Description
Poor geometry	Warning	GPS position quality has dropped below the level you have specified because the visible satellites are too close together in the sky. The TerraSync software has paused logging until geometry improves.
Real time lost	Warning	The connection to the specified source of real-time differential correction has been lost.
Too few satellites	Warning	GPS position quality has dropped below the level you have specified because there are not enough visible satellites. The TerraSync software has paused logging until more satellites become visible.
General error	System	An error has occurred. An error is indicated by the sound your field computer uses for the Critical Stop event.
Question	System	The TerraSync software requires some information or a decision from you. The question appears in a message box and is indicated by the sound your field computer uses for the Question event.



Customizing sounds

You can enable or disable all sounds as a group:

1. Tap , then, on a Pocket PC, select Settings / Volume and Sounds; on an H/PC Pro or H/PC 2000, select Settings / Control Panel / Volume and Sounds.
2. In the Enable sounds for group, select or clear the Applications check box to enable or disable warning and success sounds.
3. Select or clear the Events check box to enable or disable sounds for questions and error messages in the TerraSync software.

TIP

All the sounds used in the TerraSync software are wave (.wav) files. A default .wav file is supplied for each warning or success event that occurs in the software. You can change any of the sounds used by simply replacing the appropriate .wav file in the Windows folder on your field computer. To disable a sound, delete or rename its .wav file.

The events and their corresponding .wav files are as follows:

Sound	Filename
Feature stored	FeatureStored.wav
Dead GPS battery	GPSPatteryIsDead.wav
Low GPS battery	GPSPatteryIsLow.wav

More...



Sound	Filename
GPS connected	GPSIsConnected.wav
GPS OK	GPSIsOK.wav
Poor geometry	PoorGeometry.wav
Position logged	PositionLogged.wav
Real time lost	RealTimeIsLost.wav
Real time OK	RealTimeIsOK.wav
Minimum positions stored	MinimumPositionsStored.wav
Navigation proximity alarm	CloseUpChange.wav
Too Few Satellites	TooFewSatellites.wav
Question	The file that the field computer uses for the Question event. By default this is Question.wav. Use the Volume and Sounds system setting to replace the sound for this event.
General error	The file that the field computer uses for the Critical Stop event. By default this is Critical.wav. Use the Volume and Sounds system setting to replace the sound for this event.



Color

The TerraSync software uses color to make distinguishing important information, or similar items, easier. Color is always used in conjunction with at least one other feature such as a sound, icon, or bold text, so information is not lost if your screen uses grayscale.

The following features of the TerraSync software use color to provide extra information or to clarify the display:

- **Map layer colors**
- **Battery icon**

NOTE If your field computer has a grayscale display, the color information described in this section does not apply, and all items on screen appear in shades of gray. The default color scheme used in the TerraSync software has been selected to provide the best visibility on a color screen. To distinguish differently colored items on a grayscale field computer, it may be necessary to change the color scheme.



Map layer colors

The information displayed in the Map section is arranged in five layers. To make the map display clearer, you can select a different color for each of these **Map layers**. If a layer contains features, you can either use the feature colors assigned in the data dictionary, or set a single color for all features in the layer.

To select layer colors, tap **Layers** in the Map graphical screen and select Layer Formatting. The **Layer Formatting form** appears. You can set each layer to display in a different color. You can also set two or more layers to the same color.

The available layer colors are:

 Red	 Dark Red	 Yellow	 Dark Yellow
 Green	 Dark Green	 Blue	 Dark Blue
 Cyan	 Dark Cyan	 Magenta	 Dark Magenta
 Light Gray	 Dark Gray	 Gray	 Black



Battery icon

The level of color in each half of the battery icon in the **Status bar** indicates the level of the GPS receiver battery (left half) or the field computer's battery (right half). In addition, the color of the battery level indicates the status of the corresponding battery.

When the battery power level is sufficient for operation of the TerraSync software, the battery level in the icon appears in green:



When the battery is low, the battery level in the icon appears in yellow:



When the battery is very low, it is important that you replace it to avoid loss of GPS data. To warn you that the battery level is too low, the battery level in the icon appears in red:



The two halves of the icon can show different levels of charge and are colored appropriately. For example, if the GPS receiver battery is critical, but the field computer's battery is fully charged, the left half of the icon appears in red, while the right half is green:



The Map section

To open the Map section, tap the Section list button and select Map.

The Map section is a graphical display of the features in the open data file. It can also display a background image and GPS and navigation information.

The color of an item on the map depends on which of the **Map layers** it belongs to.

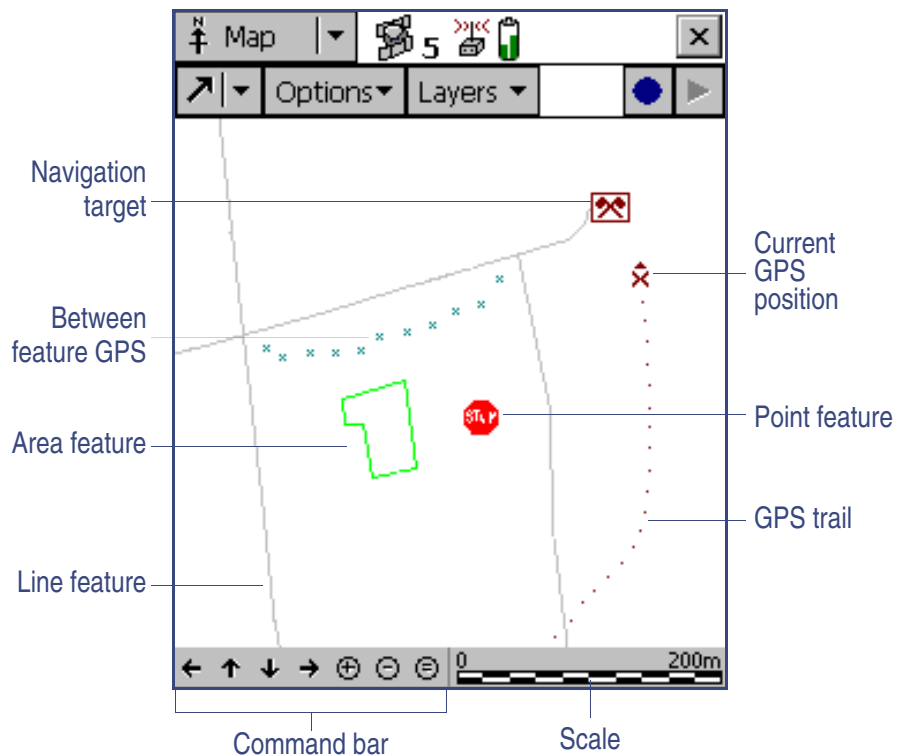

More...



For more information about the functions of the Map section, see [Using the Map section](#).

NOTE In the **TerraSync Standard edition software** you cannot display background images or imported data files.

The Map section includes:

- **GPS trail**
- **Position information**
- **Features**
- **Scale**
- **Current position**
- **Navigation target**
- **Between feature GPS**
- **Map point**
- **Bearing to go arrow**
- **Command bar**



It also includes the following buttons:

- **Create Feature**
- **Log/Resume**
- **End Feature**
- **Pause**
- **Undo**



The following modes and options are available:

- **Map tools**
- **Map option list**
- **Map layers**





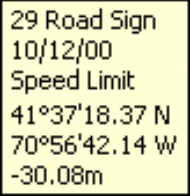





Item	Name	Description
	GPS trail	A trail of dots that shows the path you have taken recently. The GPS trail shows the last 60 GPS positions calculated by the receiver.
	Current position	The current GPS position, marked by the GPS cursor  , and your heading, shown by the heading arrow  . If you are traveling too slowly or are stationary, only the GPS cursor is displayed.
	Map point	A point that you have selected from the map which is not part of a feature. When you tap a map point its position information appears.
	Navigation target	An icon indicating the feature or point currently selected as the target for navigation. When a target is selected you can use the Navigation section to move to its location.
	Bearing to go arrow	An outlined arrow on the edge of the map, showing the approximate direction to the navigation target when it is not in the visible part of the map.



Item	Name	Description
	Features	<p>Features you have logged in the current data file. Each feature type appears using the point feature symbol or line thickness defined in the data dictionary. A feature's color is determined either in the data dictionary or by the color of the layer it appears in.</p> <p>When a feature is selected on the map, it is highlighted and its position information appears. A selected point feature is outlined, and a selected line or area feature is displayed with a bold line.</p>
	Position information	<p>A pop-up message showing the coordinates of the current map cursor location. If the selected location is a feature, the feature name and number also appear, as well the two attribute values from the feature that have been specified in the data dictionary as labels.</p>
	Between feature GPS	<p>A trail of small crosses that show all GPS positions logged but not associated with a feature.</p>





More...



Item	Name	Description
	Command bar	<p>A toolbar containing zooming and panning controls:</p> <ul style="list-style-type: none">  Pan half the map width to the left  Pan half the map height upwards  Pan half the map height downwards  Pan half the map width to the right  Zoom in  Zoom out  Zoom to extents to show all positions in all visible layers
	Scale	<p>The scale at which the map is drawn. As you zoom in or out, the scale changes accordingly.</p>

More...



Button	Name	Function
	Create Feature	Lets you start a new feature without returning to the Data section. For more information, see Creating and ending features from the Map section .
	End Feature	Lets you close the currently open feature without returning to the Data section. For more information, see Creating and ending features from the Map section .
	Undo	Deletes the last digitized position recorded for the current feature. For more information, see Digitizing .
	Log/Resume	Starts GPS position logging for the current feature, or resumes logging if logging is paused. For more information, see Controlling logging from the Map section .
	Pause	Pauses GPS position logging for the current feature. For more information, see Controlling logging from the Map section .



Map tools

Map / Map Tools

The Map section has five map tools. Only one map tool is active at a time. Tap the Map Tools list button and select a command from the list to change to a different map tool.

When you tap a point on the Map screen, the effect depends on the currently selected map tool. For example, if you tap when the Zoom In tool is active, the map zooms in to the next largest scale, centered on the point you selected.

TIP

You can use the **Command bar** to pan or zoom at any time without changing the map tool. When you use the command bar to zoom or pan, the operation is centered on the middle of the map, as if you had selected the appropriate map tool, then tapped the center of the map.

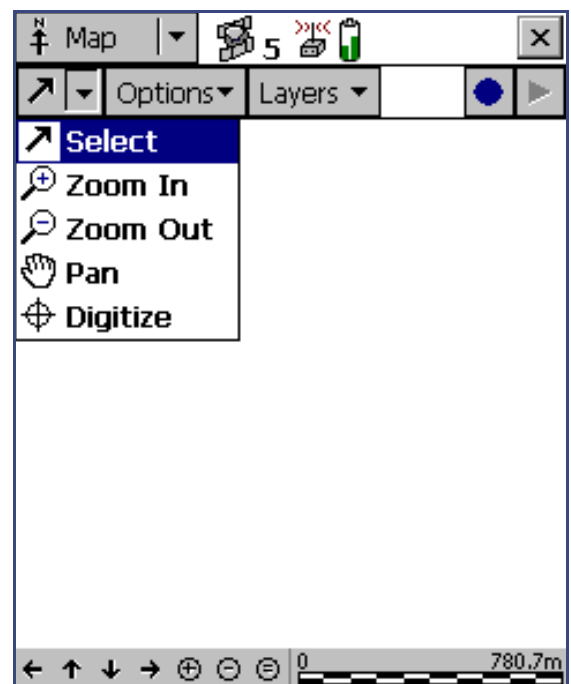

More...



The map tools are:

- **Select**
- **Pan**
- **Zoom In**
- **Digitize**
- **Zoom Out**

Use this option ...	to ...
Select	change to the Select tool. When the Select tool is active, tap a point on the map to highlight a position or a feature. Double-tap any feature to open it for update in its Attribute entry form . For more information, see Selecting features and map points .
Zoom In	change to the Zoom In tool. When the Zoom In tool is selected, tap a point on the map, or drag a rectangle, to reduce the map scale and magnify the map display. The map zooms in on the position you tap. For more information, see Zooming .
Zoom Out	change to the Zoom Out tool. When the Zoom Out tool is selected, tap a point on the map to enlarge the map scale and show a greater area on the map. The map zooms out from the position you tap. For more information, see Zooming .



Use this option ...	to ...
Pan	change to the Pan tool. When the Pan tool is selected, tap a point on the map to pan the display so the position you tapped is in the center of the screen. For more information, see Panning .
Digitize	change to the Digitize tool. When the Digitize tool is selected, tap a point on the map to create a position for a feature. For more information, see Digitizing .



Map option list

Map / Options

Tap **Options** to display the available options for the Map section.

The options are:

- **Zoom Extents**
- **Auto Pan to GPS Position**
- **Auto Pan to Selection**
- **Filter**
- **Update Selected Feature**
- **Delete Selected Feature**
- **Set Nav Target**
- **Clear Nav Target**
- **Enter Coordinates**
- **Refresh**

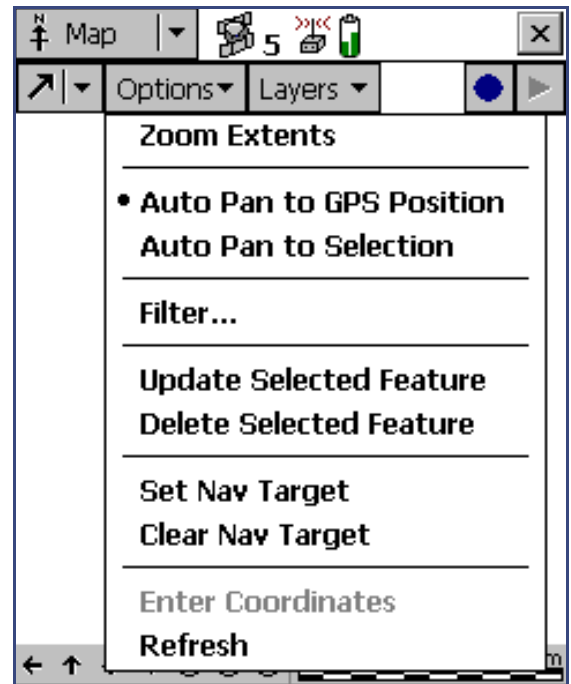

More...



Use this option ...	to ...
Zoom Extents	change the scale so that all selected layers are visible on the map screen. The Zoom extents option varies. What it shows depends on what layers are selected and whether the features are filtered. If nothing is displayed on the Map screen, the Zoom extents option does not affect the map scale.
Auto Pan to GPS Position	make sure that the current GPS position is always visible. When this option is selected, and the GPS position is off screen or close to the edge of the screen, the TerraSync software automatically pans to bring the GPS position to the center of the screen. When Auto Pan to GPS Position is active, a bullet appears beside it. NOTE <i>Either</i> Auto Pan to GPS Position <i>or</i> Auto Pan to Selection can be selected, but not both. To clear Auto Pan to GPS Position, select it again, or select Auto Pan to Selection.

More...



Use this option ...	to ...
Auto Pan to Selection	<p>make sure that the currently selected feature is always visible. When this option is selected, and the currently selected feature is off screen or close to the edge of the screen, the TerraSync software automatically pans to bring the selected feature to the center of the screen.</p> <p>When Auto Pan to Selection is active, a bullet appears beside it.</p> <p>NOTE <i>Either</i> Auto Pan to Selection <i>or</i> Auto Pan to GPS Position can be selected, but not both. To clear Auto Pan to Selection, select it again, or select Auto Pan to GPS Position.</p>
Filter	open the Data section's Filter By form , where you can set or change filtering criteria.
Update Selected Feature	<p>open the Data section's Attribute entry form for the currently selected feature, where you can update the feature's attributes or position. When you save the changes to the feature and close the attribute entry form, you are returned to the Map section.</p> <p>TIP You can also open a feature for update by double-tapping it on the map.</p>

More...



Use this option ...	to ...
Delete Selected Feature	<p>delete the currently selected feature. This is the same as the Delete option in the Data section's Update Features screen.</p> <p>NOTE Deleted features are never displayed in the map. Once you have deleted a feature, it is hidden on the map. You can only undelete a feature in the Update Features screen.</p>
Set Nav Target	make the last position you tapped the navigation target. For more information, see Setting and clearing the navigation target .
Clear Nav Target	clear the current navigation target. You do not have to select the target before clearing it.
Enter Coordinates	<p>open the Enter Coordinates form, where you can record a position for the open feature by entering its coordinates manually.</p> <p>NOTE To enter coordinates manually, you must be in Digitize mode with a feature open.</p> <p>For more information, see Creating manual positions.</p>
Refresh	clear the map display and redraw it.



Map layers

Map / Layers

Tap **Layers** to view the list of layers you can display on the map, and commands for formatting layers.

The commands on the map layers list are:

- **Filtered Features**
- **Unfiltered Features**
- **Between Feature GPS**
- **Background**
- **GPS Trail**
- **Background File**
- **Layer Formatting**

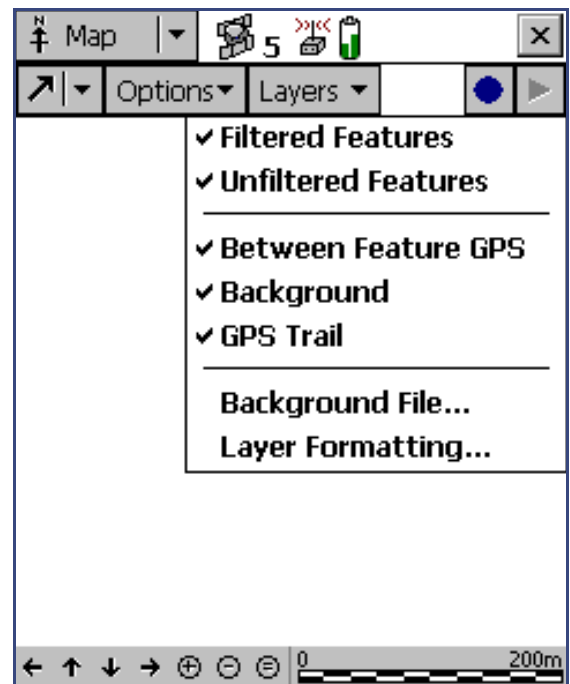

Use this option ...	to ...
Filtered Features	hide or display filtered features on the map and in the Data section. When this option has a check mark (✓) beside it, filtered features are visible. Select it to clear the check mark and hide filtered features from view. TIP You can set or clear filters in the Map section or in The Data section .
Unfiltered Features	hide or display unfiltered features on the map and in the Data section. When this option has a check mark (✓) beside it, features that have not been filtered are visible. Select it to clear the check mark and hide unfiltered features from view. NOTE When you hide or show filtered features or unfiltered features in the Data section, they are also shown or hidden in the Map section. When you hide or show filtered or unfiltered features in the Map section, they are also hidden or shown in the Data section.
Between Feature GPS	hide or display Between feature GPS positions on the map.



Use this option ...	to ...
Background	hide or display the background file if one is selected. When this option has a check mark (✓) beside it, features in the background file are visible. Select this option to clear the check mark and hide background features from view. This option is not available in the TerraSync Standard edition software, because you cannot open background files in this edition.
GPS Trail	hide or display the GPS trail .
Background File	display the Background File form where you can select a data or background file to be used as the map background, or clear the currently selected background. This option is not available in the TerraSync Standard edition software, because you cannot open background files in this edition.
Layer Formatting	open the Layer Formatting form where you can change the colors and line thicknesses used for the layers in the map.



Background File form

Map / Layers / Background file

When you tap **Layers** and select Background file, the Background File form appears. Use this form to select a file to be displayed in the background of the map, or to clear the current selection.

NOTE This form is not available in the **TerraSync Standard edition software**.

There are two types of file that can be displayed in the background:

- Data files
- Background files containing **vector** information or **raster** information

Any data file in the TerraSync software can be selected as the background file, provided it is not already open in the Data section. When you open a data file in the background, its features are visible but cannot be selected, edited, or deleted.

Files	Format
None	
Sample Background	BMP

More...



If you want to use a data file in the background, but will not be opening it as a data file, you can transfer the file to the TerraSync software as a background file. This uses less storage space, because the attribute information is removed. You cannot open a background file for data collection or update, and a background data file's features cannot be selected, updated, or deleted.

The TerraSync data file format is the only vector format supported in version 2.20 of the TerraSync software. If you want to use Shapefiles as background files, use the **Read from Shape form** in the Data section to convert Shapefiles into TerraSync data files.

You can also transfer raster files such as aerial photographs to the TerraSync software as background files. The supported formats are bitmap (.bmp), JPEG (.jpg), and MrSID (.sid). An image file must be transferred with a World (.wld) file that tells TerraSync how the pixels in the file relate to real-world coordinates, and a coordinate system file that specifies the coordinate system that the image file uses. You can create the World file in your GIS. You can create the coordinate system file either in the GPS Pathfinder Office main program, or in the Data Transfer utility at the time of transfer.



Web map server

In addition to background files that you have transferred to your field computer, you can connect to a Web map server (also known as an Internet map server, or IMS) and download raster background images. Before you download background files from a Web map server, you need to use **Panning** or **Zooming** to make sure that the area for which you want a background image is displayed on the map. Provided the map server covers the area you are in, it will provide a background image that matches the current map extents.

Next, you must connect to the Internet. Do this using your normal connection method. You cannot connect to the Internet from within the TerraSync software.

NOTE Trimble is not responsible for setting up your Internet connection, or for solving any Internet problems that may occur. For questions or support concerning your Internet connection, please contact your System Administrator or Internet Service Provider (ISP).



Once you have established an Internet connection, open the **Background File form** in the TerraSync software. Select Internet from the Location field, then use the fields that appear to specify a Web map server, a service, and the layers from that service that you want to download. Click **OK** to close the Background File form and download the selected background map. This may take some time. When a download is in progress, an animated icon  appears in the top left corner of the map. Once the background file is downloaded, the hourglass icon appears while the image is rendered.

If you pan or zoom beyond the extents of the downloaded image, new images are downloaded automatically and displayed in the background of the map. To stop automatic downloading, either clear the map server's address from the URL field, or set the Location field to Device and select None from the list of files.

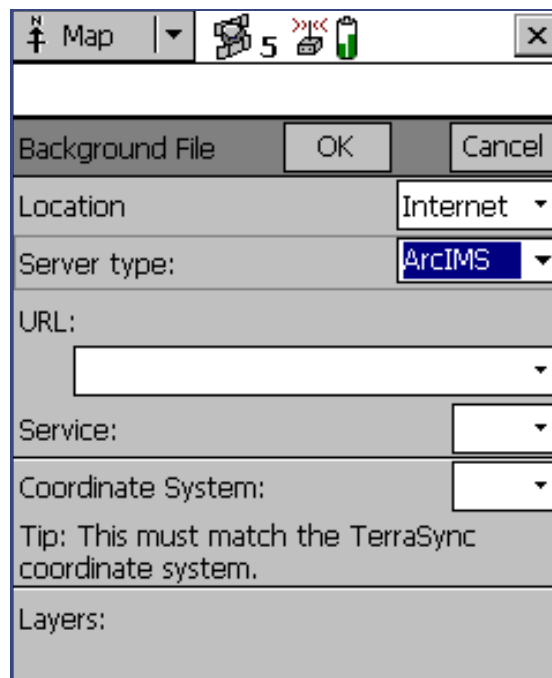

TIP Background settings are saved when you exit the TerraSync software, so when you restart the software, any Web map server session that you have configured automatically starts again.



The first field in the Background File form is the **Location** field. When Device, Card, or a drive letter is selected in the Location field, the following fields also appear:

- **File Type**
- **Files**

When Internet is selected in the Location field, the following fields also appear:

- **Server type**
- **URL**
- **Service**
- **Coordinate system**
- **Layers**



Use this field ...	to ...	Default value
Location	<p>select the location of the files to be listed in the Files field. The options are:</p> <ul style="list-style-type: none"> • Device list files stored in the main memory of the CE device. • Card list files on a storage card inserted in the CE device. If you have more than one card connected, there is a numbered option for each card (Card 1, Card 2, and so on). • (Drive letter) list files stored in the specified disk drive on the PC. If the PC has more than one writable disk drive, there is an option for each drive (A:, C:, and so on). • Internet list files stored on a Web map server. 	Device <i>or</i> C:

More...



Use this field ...	to ...	Default value
File Type	<p>select the type of file to list in the Files field. The options are:</p> <ul style="list-style-type: none"> • Background data files that have been transferred to the field computer as background files, or raster (bitmap) image files • Data data files in the SSF file format, including .ssf, .imp, and .cor files 	Background

More...



Use this field ...	to ...	Default value
Files	<p>select the file that you want to display in the background. The Format column shows the format of each file in the list. The options are:</p> <ul style="list-style-type: none"> • BMP a bitmap (.bmp) file • JPEG a .jpg file • MrSID a .sid file • Trimble a Trimble data file • Vector a background file containing vector data <p>Select a filename from this list, or select None to close the current background file and show no background information.</p>	None

More...



Use this field ...	to ...	Default value
Server type	<p>select the type of Web map server you want to connect to. The options are:</p> <ul style="list-style-type: none"> • ArcIMS a map server that uses the ArcIMS protocol • Open GIS a map server that conforms to the Open GIS standard 	Open GIS
URL	<p>specify the Internet address of the map server. Select a URL from the drop-down list, or enter the URL of the server you want to connect to. Once you successfully connect to a server, it is added to the drop-down list.</p>	None
Service	<p>select the map service available from the selected server that you want to select background images from.</p> <p>If you want to connect to an Open GIS server, leave this field blank. Open GIS servers do not provide services.</p>	None

More...



Use this field ...	to ...	Default value
Coordinate system	select the coordinate system that you want to download maps in. The option you select here must match the coordinate system configured in the Coordinate System form in the Setup section. Some servers do not let you select a coordinate system for the images you download. If this field is not available, visit the website for the map server to determine the coordinate system required, and then select the same system in the Setup section.	None
Layers	select the layers that you want to download. Under this separator field, a check box appears for each layer in the selected service.	None



Layer Formatting form

Map / Layers / Layer Formatting

When you tap **Layers** and select Layer Formatting, the Layer Formatting form appears. Use this form to change the colors assigned to items in the five **Map layers**.

All items in the same layer appear in the color assigned to their layer. Alternatively, for features in the open data file, you can use the colors assigned in the data dictionary. The feature symbols, size, and line thicknesses are always taken from the data dictionary.

To change the selected color for a layer, select a color option from that layer's Color field. The option you select appears in the color it represents.

The available layer colors are specified in **Map layer colors**.

The screenshot shows the 'Layer Formatting' dialog box. It has a title bar with a 'Map' dropdown and several icons. Below the title bar are 'OK' and 'Cancel' buttons. The main content area is divided into sections: 'Filtered Features' with 'Color Source' set to 'Layer Color' and 'Color' set to 'Dark Green'; 'Unfiltered Features' with 'Color Source' set to 'Data Dictionary'; 'Vector Background' with 'Color Source' set to 'Data Dictionary'; and 'Between Feature GPS' with 'Color' set to 'Dark Cyan'.

More...





The Layer Formatting form contains the following:

- **Filtered Features** • **Color Source** • **Color**
- **Unfiltered Features** • **Color Source** • **Color**
- **Vector Background** • **Color Source** • **Color**
- **Between Feature GPS** • **Color**
- **GPS Trail** • **Color**



Use this field ...	to ...	Default value
Filtered Features Color Source	set display options for the Filtered features layer. specify whether to display filtered features using the layer color or the color specified in the data dictionary.	Layer color
Color	select the color for filtered features in the data file. This field only appears if the Color Source field is set to Layer color.	 Dark Green
Unfiltered Features Color Source	set display options for the Unfiltered features layer. specify whether to display unfiltered features using the layer color or the color specified in the data dictionary.	Data dictionary
Color	select the color for unfiltered features in the data file. This field only appears if the Color Source field is set to Layer color.	 Black



Use this field ...	to ...	Default value
Vector Background	set display options for the Background layer. NOTE This field is not available in the TerraSync Standard edition software .	
Color Source	specify whether to display features in a file that is open in the background using the layer color or the color specified in the data dictionary.	Data dictionary
Color	select the color for background features if the background file contains feature information. This field only appears if the Color Source field is set to Layer color. NOTE This field is not available in the TerraSync Standard edition software .	 Dark Magenta
Between Feature GPS	set display options for the Between Feature GPS layer.	
Color	select the color for Between feature GPS positions.	 Dark Cyan

More...



Use this field ...	to ...	Default value
GPS Trail	set display options for the GPS Trail layer. NOTE In addition to the GPS trail, the following items appear in the color assigned to the GPS Trail layer: <ul style="list-style-type: none"> • Current position • Map point • Navigation target • Bearing to go arrow However, when the GPS Trail layer is hidden, these map items are not hidden.	
Color	select the color for the GPS trail .	 Dark Red



Enter Coordinates form

Map / Options / Enter Coordinates

When you tap **Options** and select Enter Coordinates, the Enter Coordinates form appears. Use this form to record a manual position for the open feature by entering its coordinates.

This option is only available if there is an open feature and the Map section is in **Digitize** mode. A point feature can contain only one position, but a line or area feature can contain any number and combination of manual, digitized, and GPS positions.

For more information, see **Creating manual positions**.

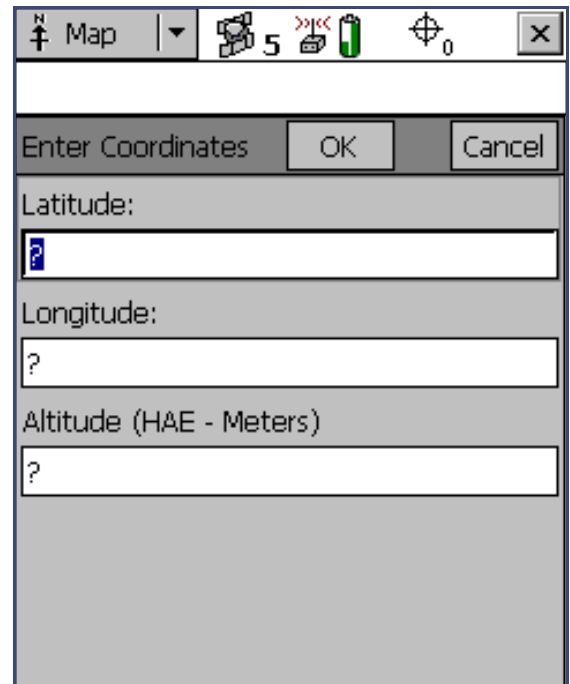

If the current coordinate system is Lat/Long, the Enter Coordinates form contains the following:

- **Latitude**
- **Longitude**
- **Altitude**

If the current coordinate system uses North/East, the Enter Coordinates form contains the following:

- **North**
- **East**
- **Altitude**

If you have enabled USNG display in the **Coordinate System** form, the Enter Coordinates form contains the following:

- **USNG**
- **Altitude**



Use this field ...	to ...	Default value
Latitude	<p>specify the latitude of the manual position. You can use one of the following formats:</p> <ul style="list-style-type: none"> • DD°MM'SS.ss" • DD°mm.mmm' • DD.ddd° <p>NOTE To indicate a Southern hemisphere latitude or Western hemisphere longitude, you must include the hemisphere letter (S or W) or a minus sign (-). The hemisphere letter or plus sign is optional for Northern or Eastern hemisphere positions.</p> <p>TIP The symbols for degrees (°), minutes ('), and seconds (") can be omitted or replaced with a space, but you must include the decimal point (.).</p>	(none)

More...



Use this field ...	to ...	Default value
Longitude	<p>specify the longitude of the manual position. The formats you can use are as for the Latitude field.</p>	(none)
North	<p>specify the northing of the manual position, in the coordinate units specified in the Coordinate System form.</p>	(none)
East	<p>specify the easting of the manual position, in the coordinate units specified in the Coordinate System form.</p>	(none)
USNG	<p>specify the northing and easting of the manual position, in USNG format.</p>	(none)
Altitude	<p>specify the altitude of the manual position. The altitude is expressed as a Height Above Ellipsoid or Mean Sea Level, depending on the option configured in the Coordinate System form, and is in the altitude units specified in this form.</p>	(none)



Using the Map section

You can move around the map, hide or display different parts of the map, and select features or points of interest.

NOTE In the **TerraSync Standard edition software** you cannot open an imported file.

- **Selecting features and map points**
- **Panning**
- **Zooming**
- **Creating and ending features from the Map section**
- **Digitizing**
- **Creating manual positions**
- **Setting and clearing the navigation target**



Selecting features and map points

When a feature is selected in **The Data section**, it becomes the selected feature in the map.

When you select a feature from the map and there is no open feature in the Data section, the feature selected in the map is highlighted in the Choose Feature list in the Data section's **Update Features** screen.

To select a feature on the map, make sure that the **Select** tool is active, then tap the feature. The feature is highlighted and position information, including the coordinates, feature number, and name, is displayed.

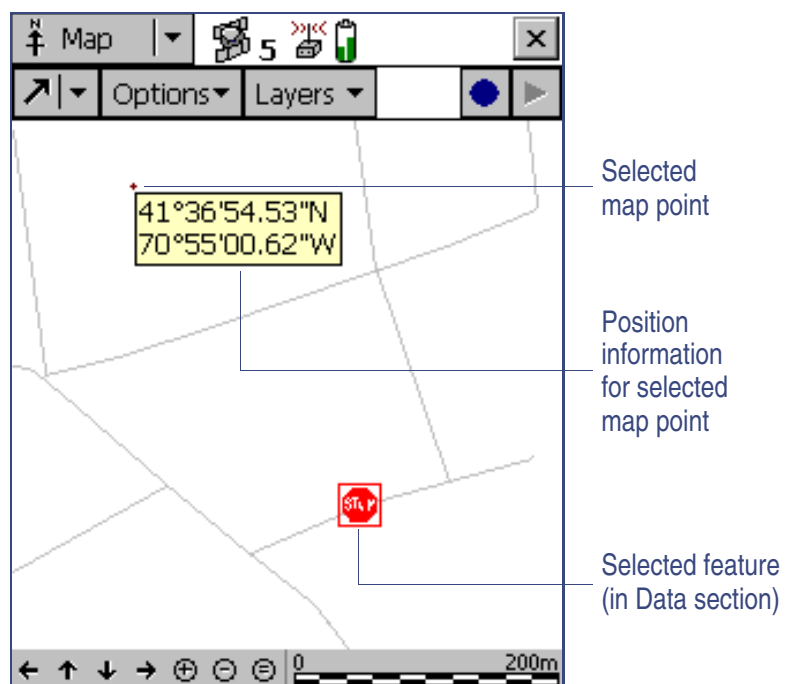

More...



The position information remains visible until you tap it, or tap another feature, a different map point, or anywhere else on the screen. The feature remains selected (highlighted) until another feature is tapped.

You can also select any **Map point**. When you select a map point (not a feature), any selected feature on the map remains highlighted.



Panning

When you pan, you change the area that is visible in the Map screen by sliding the map left, right, up, or down. Panning does not change the scale at which you are viewing the map.

You can pan to any location by selecting the **Pan** tool and tapping on the location. The map pans so the selected location is in the center of the display.

To pan half a screen width or height in any direction without changing the currently selected map tool, tap the appropriate panning button on the **Command bar** at the bottom of the Map screen.

The two Auto Pan options in the **Map option list** let you control the map automatically. You can set either option, or clear both to retain full manual control over the map display.

When you set **Auto Pan to GPS Position**, the TerraSync software always ensures that the map shows the current GPS position. Whenever the GPS position moves to or beyond the edge of the display, the map automatically pans until the GPS position is in the center of the screen.

Auto Pan to Selection ensures that the currently selected position is always visible by automatically panning whenever the selected feature is at the edge of the display, or beyond it. When you tap close to the edge of the map, the map automatically pans (half a screen width or height) in the direction of the movement. The selected point remains at the same geographic position. In these circumstances, the current GPS position may not be visible.



Zooming

When you zoom, you change the map scale to display a larger or smaller area. You can zoom in to view a few features that are close together, or zoom out for an overview of the features you have collected so far.

To zoom in, make the Zoom In tool active and tap the location on the map you want to zoom in to. Alternatively, tap the Zoom In button on the **Command bar** to zoom in on the center of the map.

You can also zoom in by dragging across the map when the Zoom In tool is active. As you drag, a rectangle appears. The diagonal of the rectangle is the line between the point where you started dragging and the last point you dragged to. When you stop dragging, the map zooms in on the rectangle.

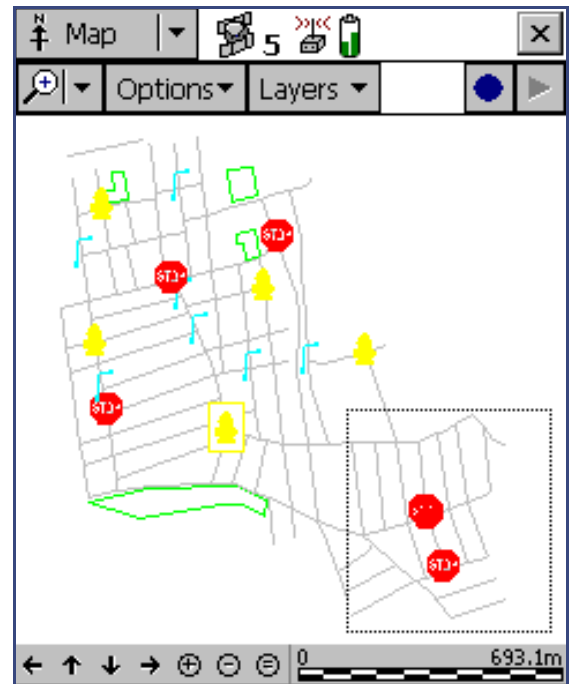

NOTE If the rectangle you draw is very small, the map does not zoom.



Similarly, to zoom out, make the Zoom Out tool active and tap the location you want to zoom out from. Alternatively, tap the Zoom Out button on the **Command bar** to zoom out from the center of the map.



To view all the features in all visible layers, tap the Zoom Extents button on the **Command bar**, or select Zoom Extents from the **Map option list**. The map scale increases until all points in all the visible layers appear. **Map layers** you can display include features in the data file and background file, the current GPS position, and past GPS positions.

NOTE You cannot zoom out by dragging a rectangle. This method is for zooming in only.



Creating and ending features from the Map section

✚ Map / Create Feature or Map / End Feature

You can use the Create Feature  and End Feature  buttons in the Map section to open a new feature, or to close a feature that is already open in the Data section. When you tap the Create Feature button, a drop-down list appears, showing each feature type that is defined in the open file's data dictionary. Select a feature type from this list to open its attribute entry form.

Whenever a feature is open, whether it was opened from the Map section or from the Data section, you can close it by tapping the End Feature button. If you have collected insufficient positions, have not entered all the feature's attribute values, or have set the **Confirm End Feature** field in the Setup section's Logging Settings form to Yes, you will be asked to confirm that you want to close this feature. When you close a feature using the End Feature button, you are returned to the section that you opened the feature from (either the Map section, if you used the Create Feature button, or the Data section).

TIP To create digitized positions from the map, you need an open feature. You can use the Create Feature button to open a new feature without switching to the Data section. For more information, see **Digitizing**.



Digitizing

Digitizing is the process of creating positions for a feature by selecting points on the map instead of using GPS positions. A line or area feature can contain both GPS and digitized positions, but you must pause GPS logging before you can digitize positions.

Before you start to record digitized positions, make sure the new or existing feature that you want to add positions to is open in the Data section. If no feature is open, you can use the Create Feature button in the Map section to quickly open a new feature. For more information, see **Creating and ending features from the Map section**. Next, make sure that GPS logging is paused.

TIP Use the **Log Later** option to prevent GPS logging from starting automatically when you start a new feature.

Then make the **Digitize** tool active. The Digitize icon appears in the **Status bar**. Tap the location on the map where you want to create a position.

If the location you tap is close to an existing position, the new position will “snap” to the same location. This is a useful feature when you want to create line or area features with shared boundaries.



TIP

Whether or not a digitized position snaps to an existing one depends on how close the two positions are in the map display, not the distance between their actual coordinates. To record a digitized position without snapping to a nearby position, zoom in to increase the distance between the two positions on the screen.

To record a digitized area or line feature, tap the location where you want each vertex. The number beside the Digitize icon increments to show the number of digitized positions in the current feature. A line appears on the map, joining all the vertices recorded so far:

A digitized point feature can contain only one position, so if you tap again while a point feature is open, an error message appears.

Any offset you have configured for the feature is applied to each digitized position. The map location that you click is the position that the offset is measured from.

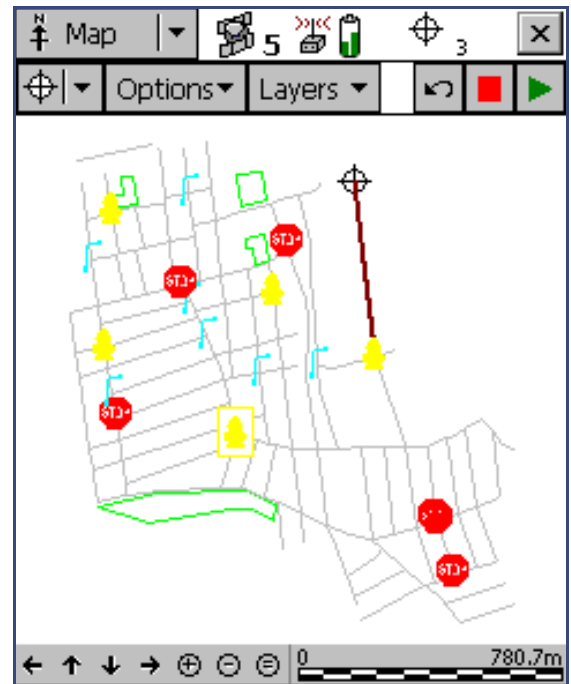

More...



If you tap the wrong location, use the Undo button  to remove the incorrect position. You can undo any number of positions recorded for the current feature, in reverse order, up to the last GPS position recorded.

For example, if you have recorded four digitized positions, you can undo the fourth, then the third, and then the second position, by tapping the Undo button three times. Once you have undone all the positions in a feature, the Undo button becomes unavailable.

NOTE

You cannot undo a GPS position. Once you have undone all digitized positions in the feature up to the last GPS position, the Undo button becomes unavailable, even if there are other digitized positions in the feature that you recorded before the GPS position.

To record GPS positions, simply tap the Resume button to resume logging GPS. When you are logging GPS positions, you cannot record digitized positions. However, you do not leave Digitize mode until you select one of the other **Map tools**, so you can quickly switch between GPS and digitized positions using the Pause and Resume buttons.



Creating manual positions

A manual position is a position that has been created by entering its coordinates manually. A line or area feature can contain a mixture of GPS, manual, and digitized positions, but a point feature can contain either GPS positions or a single manual or digitized position.

Manual positions can be recorded under the same conditions as digitized positions: there must be a feature open, GPS logging must be paused, and the **Digitize** tool must be active. For more information, see **Digitizing**.

To record a manual position, tap **Options** in the Map section and then select Enter Coordinates. The **Enter Coordinates form** appears. Enter the coordinates of the position, then tap **OK** to close the form and store the position. The fields that appear (Latitude/Longitude/Altitude or North/East/Altitude) depend on the current coordinate system.



Setting and clearing the navigation target

To navigate to a location using the Navigation section, you must set a navigation target. You can set or clear the target either in the Map graphical screen or in the Data section.

To set the navigation target in the Map section, tap the map point or feature you want to set as the target, then tap **Options** and select Set Nav Target. The target icon appears over the selected point feature, or at the feature's start point if you selected a line or area feature.

TIP A target icon also appears beside the selected feature in the **Update Features** screen.



To clear the navigation target, tap **Options** and select Clear Nav Target. The target icon disappears and the Navigation section displays the message **Set your nav target in the Map or Data section**. You cannot navigate until you set a new target.



Controlling logging from the Map section

📍 Map / Log or Map / Pause

When the attribute entry form for a feature is open in the Data section, you can use the Log and Pause buttons in the Map to start, pause, or resume logging, just as you would tap **Log**, **Pause**, or **Resume** in the Data section.

The two buttons perform the same function, so they are synchronized. For example, if you tap **Pause** in the Data section, its label changes from **Pause** to **Resume**, and logging is suspended. At the same time, the Log button  in the Map section is replaced by the Pause button . You can use either the Log button in the Map section or **Resume** in the Data section to start logging again.

For more information, see [Pausing and resuming logging](#).



The Data section

To open the Data section, tap the Section list button and select Data.

Use this section to open data files, collect new data, update existing data, and manage files in the field.

The Data section has five subsections:

- **New File**
- **Existing File**
- **Update Features**
- **Collect Features**
- **File Manager**

The File Manager subsection is always available. The New File and Existing File subsections are available when no data file is open. The Update Features and Collect Features subsections are only available if there is a data file open.

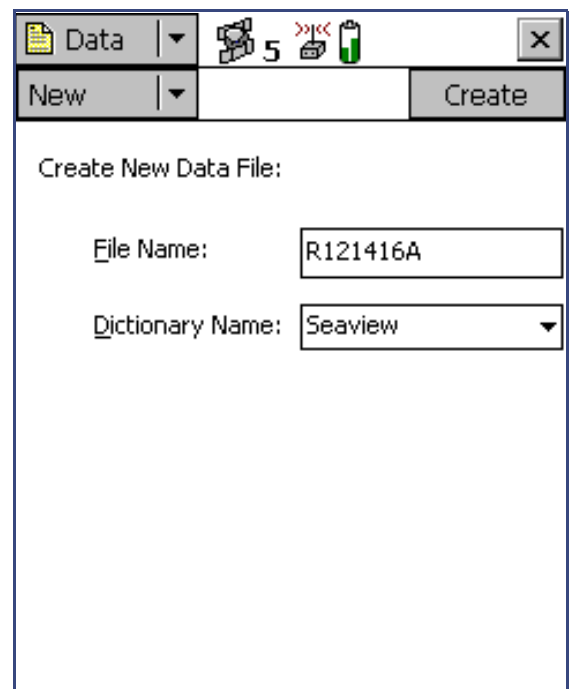

File Name: R121416A

Dictionary Name: Seaview



New File

Data / New File

To open the New File subsection, tap the Subsection list button and select New File. The New File screen appears:

Use the New File subsection to create a new data file for logging features and GPS positions.

This form contains the following fields:

- **File Name**
- **Dictionary Name**

When you have selected a filename and a data dictionary, tap **Create** to create a new file and begin data collection in the **Collect Features** subsection.

TIP Once you have logged features to the new file, you can switch to the **Update Features** subsection to edit features you have collected so far.

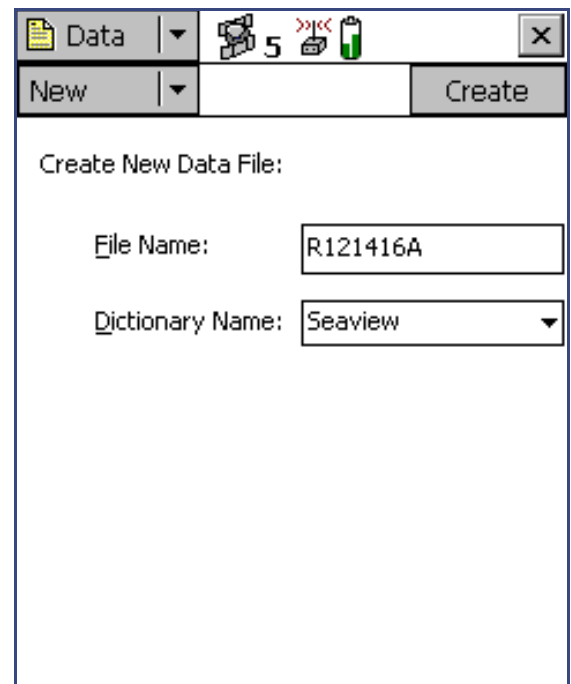

Use this field ...	to ...
File Name	<p>specify a name for the new file. When you open this section, the TerraSync software automatically generates a filename for the new data file, using the date and time from the field computer's clock. It uses the formula RMMDDHHX where:</p> <ul style="list-style-type: none">• R is the Filename Prefix,• MM is the current month,• DD is the current day of the month,• HH is the current hour of the day,• X increments within this hour, starting at A for the first file in that hour, then B for the second file, and so on. <p>TIP You can change the prefix character in the Logging Settings form in the Setup section.</p> <p>The auto-generated filename is only a suggestion. You can edit it or enter an entirely different name. Filenames must follow the naming rules for Windows.</p>



Use this field ...	to ...
Dictionary Name	<p>select a data dictionary from the list of data dictionaries currently loaded into the TerraSync software. The default data dictionary is the last dictionary you used.</p> <p>The Generic data dictionary is always available. It lets you record point, line, and area features, each with a simple descriptive attribute.</p> <p>NOTE When you create a data file, a copy of the data dictionary you select is permanently associated with that file. This embedded data dictionary determines what types of features can be recorded to the file, and what attributes the features have.</p>



Collect Features

Data / Collect Features

To open the Collect Features subsection, tap the Subsection list button and select Collect Features. The Collect Features screen appears:

NOTE This subsection is only available when a file is open. Use the **New File** subsection to open a new data file, or the **Existing File** subsection to open an existing data file.

Use this form to select a feature type to add. To add a feature, select it from the Choose Feature list and tap **Create**. An **Attribute entry form** appears.

You can also tap **Options** to display the **Collect Features option list**.

The Collect Features form contains the following:

- **Create**
- **File**
- **Choose Feature list**

More...



Use this button ...	to ...
Create	add a new feature of the selected type. When you tap Create , the Attribute entry form for the selected feature in the Choose Feature list appears. TIP The Map screen also has a Create Feature button.

Use this field ...	to ...
File	view the filename of the open file. This field is read-only.
Choose Feature list	select the type of feature you want to create. The list contains the following columns: <ul style="list-style-type: none"> • Type the type of feature, indicated by the line or area icon, or the point symbol configured in the data dictionary. • Name the name of the feature.



Collect Features option list

Data / Collect Features / Options

In the Collect Features subsection, tap **Options** to display the available options.

The options are:

- **Logging interval**
- **Repeat**
- **Log Now**
- **Log Later**
- **Trigger <sensor name>**
- **Continue**



Use this option ...	to ...
Logging interval	open the Logging interval form where you can configure the logging interval for all features of the selected type in the open data file.
Repeat	<p>set the default attribute values for each new feature to the same values you entered for the last feature of that type. This overrides any default values set in the data dictionary.</p> <p>The Repeat option lets you record a series of similar features quickly and efficiently. You can change any of the attributes of the current feature or simply accept the repeated values.</p> <p>When Repeat is selected, a check mark (✓) appears beside it in the option list. When Repeat is not selected, attributes for new features use the default values set in the data dictionary, if any.</p> <p>For more information, see Repeating features.</p>
Log Now	<p>log positions for a new feature as soon as you begin the feature. You can pause and resume logging at any time.</p> <p>When Log Now is selected, a bullet (•) appears beside it in the option list.</p>

More...



Use this option ...	to ...
Log Later	<p>pause logging of positions for a new feature until you tap Log in the attribute entry form. The pause icon flashes in the Status bar when logging is paused.</p> <p>When Log Later is selected, a bullet (•) appears beside it in the option list.</p>
Trigger <sensor name>	<p>send a data request to the sensor. If the sensor is configured to fill in an attribute value, the specified attribute's value is updated with the sensor message.</p> <p>NOTE This option only appears if the sensor is configured to provide data when requested. To do this, in the Sensor Properties form set the Receive Mode field to Requested, and set the Request Intervals field for the feature type to Trigger.</p> <p>NOTE This option does not appear in the TerraSync Standard edition software.</p>

More...



Use this option ...	to ...
Continue	<p>resume logging a line or area feature that you logged previously. You can stop logging a line or area feature, record other features on or near it, then use Continue to return to logging the line or area feature without beginning a new feature.</p> <p>Select the Continue option to open the Continue feature form, where you can select a feature to continue. When you select a feature, the attribute entry form for the last line or area feature you logged opens, and logging resumes from the last position. In the line or area feature, the last position logged and the new positions are joined up automatically.</p> <p>For more information, see Continuing line and area features.</p>



Attribute entry form

Data / Collect Features / Create

To add a new feature, select it from the Choose Feature list in the **Collect Features** screen and tap **Create**. An attribute entry form appears. Use the attribute entry form to enter attribute values for the feature.

To enter a value for an attribute, select the attribute field. The method of data entry you use will depend on the availability of physical or virtual keyboards, and on the type of field selected. To finish data entry on a field, either select another field, or use the Enter key on the real or virtual keyboard to move to the next field.

For more information on data entry techniques, see **Data entry**.

When you have entered all the attribute data and collected positions for the feature, tap **OK**. The feature is stored and the Collect Features screen reappears.

More...



TIP You can also use the **End Feature** button in the Map screen to close the current feature.

To discard a feature, tap **Cancel**. You are prompted to confirm that you want to abandon changes. This will discard the feature attributes and positions.

You can also tap **Options** to view the **Feature option list**, or use **Log**, **Pause**, and **Resume** to start or stop logging GPS positions. For more information, see **Pausing and resuming logging**.



Pausing and resuming logging

 **Data / Collect Features / Create / Pause/Resume** or

 **Data / Update Features / Begin / Pause/Resume**

When the TerraSync software is logging GPS positions, the logging icon appears in the status bar. Tap **Pause** to pause logging. While paused, TerraSync stops logging GPS positions and the pause icon flashes over the logging icon in the status bar.

When GPS logging is paused, the TerraSync software does not record GPS positions. However, if carrier logging is enabled, background logging of carrier data does continue.

Use the pause function if you want to stop logging briefly. For example, you could pause logging if you are collecting a line feature and you want to stop and enter attribute values, or you have to travel around an obstacle before returning to the line.

To resume logging GPS, tap **Resume**. The pause icon stops flashing and the logging icon appears again. Each time you resume logging while collecting a line or area feature, the TerraSync software immediately logs a GPS position (regardless of the logging interval that you have set for line/area features).

TIP You can also start, pause, and resume logging from the Map section. For more information, see **Controlling logging from the Map section**.



Feature option list

 **Data / Collect Features / Create / Options** or

 **Data / Update Features / Begin / Options**

In the attribute entry form, tap **Options** to display the available options. These options are available whether you are adding a new feature or updating an existing feature. The options are:

- **Offset**
- **Segment Line**
- **Pause**
- **New Vertex**
- **Trigger <sensor name>**
- **Resume**
- **Logging Interval**
- **Log**

Use this option ...	to ...
Offset	open either the Offset form where you can enter or edit the offset for the selected line or area feature, or the Point offset type form where you can choose what type of offset to record for the selected point feature.



More...

Use this option ...	to ...
New Vertex	open the Vertex form where you can record an averaged vertex for the selected line or area feature.
Logging Interval	open the Logging interval form where you can change the logging interval for the selected feature type.
Segment Line	segment the current line feature. This ends the current line feature and immediately starts a new feature of the same type. The first position of the new feature and the last position of the old feature are at the same location, which is a position recorded when you select the Segment Line option. For more information, see Segmenting line features .



More...

Use this option ...	to ...
Trigger <sensor name>	send a data request to the sensor. If the sensor is configured to fill in an attribute value, the specified attribute's value is updated with the sensor message. Otherwise, an uninterpreted sensor data record is added to the data file. NOTE This option only appears if the sensor is configured to provide data when requested. To do this, in the Sensor Properties form set the Receive Mode field to Requested, and set the Request Intervals field for the feature type to Trigger. NOTE This option does not appear in the TerraSync Standard edition software .
Log	start logging GPS positions.
Pause	suspend logging of GPS positions.
Resume	start logging GPS positions again after pausing logging.



Offset form

Data / Collect Features / Create / Options / Offset or

Data / Update Features / Begin / Options / Offset

When you select the Offset option from the **Attribute entry form** for a line or area feature, the Offset form appears:

Recording an offset lets you log accurate position information for a feature without traveling over it. For example, to record a road centerline, it is safer to walk beside the road at a constant distance from the centerline.

TIP You can use a **laser rangefinder** to record offsets. For more information, see **Using a laser rangefinder to record offsets**.

NOTE You can only enter one offset for each feature you collect.

More...



If the **Offset Format** is set to Horizontal/Vertical, the Offset form contains the following fields:

- **Direction**
- **Horizontal distance**
- **Vertical distance**

If the **Offset Format** is set to Slope/Inclination, the Offset form contains the following fields:

- **Direction**
- **Slope distance**
- **Inclination**

Use this field ...	to ...	Default value
Direction	select the direction the feature lies in, relative to your path of travel. The options are: <ul style="list-style-type: none"> • Left • Right For example, if you travel clockwise around a building, the feature you are logging is to the right of the path you are traveling, so select Right.	(none)
Horizontal distance	enter the two-dimensional distance to the feature. The horizontal distance ignores any difference in height between your position and the feature.	0.00 m
Vertical distance	enter the vertical distance between your position and the feature.	0.00 m

More...



Use this field ...	to ...	Default value
Slope distance	enter the distance from your position to the feature, including any difference in height.	0.00 m
Inclination	enter the angle of inclination between your position and the feature.	0.00°



Point offset type form

 **Data / Collect Features / Create / Options / Offset** or

 **Data / Update Features / Begin / Options / Offset**

When you select the Offset option from the **Attribute entry form**, and the selected feature is a point feature, the Point offset type form appears:

Use this form to specify the type of offset to record. Select an option and tap **OK** to open the corresponding form:

- **Distance-Bearing Offset form**
- **Distance-Distance Offset form**
- **Triple Distance Offset form**
- **Bearing-Bearing Offset form**
- **Triple Bearing Offset form**

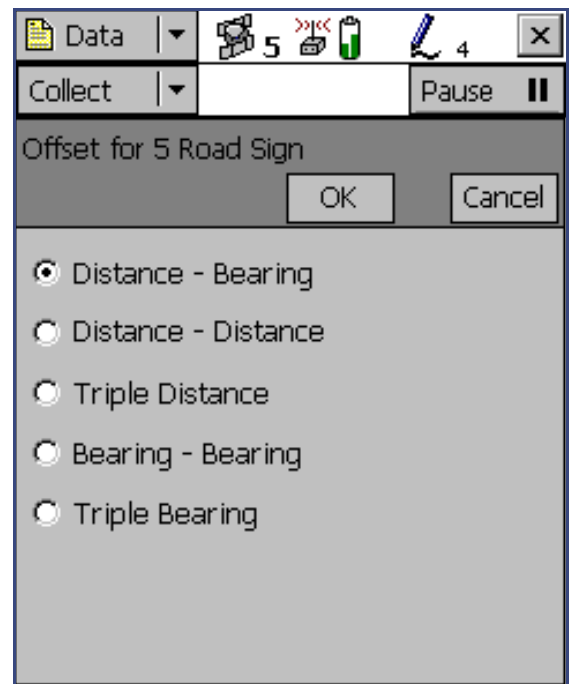

Offset for 5 Road Sign

OK Cancel

Distance - Bearing

Distance - Distance

Triple Distance

Bearing - Bearing

Triple Bearing



Distance-Bearing Offset form

 **Data / Collect Features / Create / Options / Offset** or

 **Data / Update Features / Begin / Options / Offset**

When you select the Distance-Bearing option in the **Point offset type form**, the Distance-Bearing Offset form appears:

When you set a distance-bearing offset, you specify a distance and a bearing from north. The feature lies at the point where the bearing line intersects the circle with the specified distance as its radius.

To specify a distance-bearing offset, simply fill in the fields on this form and tap **OK**.

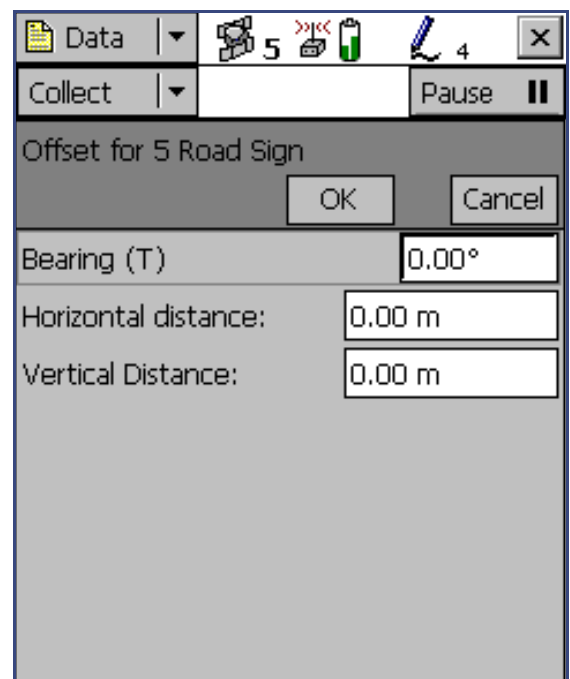

Offset for 5 Road Sign

OK Cancel

Bearing (T) 0.00°

Horizontal distance: 0.00 m

Vertical Distance: 0.00 m



If the **Offset Format** is set to Horizontal/Vertical, the Distance-Bearing Offset form contains the following fields:

- **Bearing**
- **Horizontal distance**
- **Vertical distance**

If the **Offset Format** is set to Slope/Inclination, the Distance-Bearing Offset form contains the following fields:

- **Bearing**
- **Slope distance**
- **Inclination**



Use this field ...	to ...	Default value
Bearing	enter the bearing, in the selected angle units, from the reference position to the point feature you are logging. For example, if you are facing North and the feature is directly to your right (East), enter 90°. The angle you enter is relative to the configured north reference, which is indicated by a T (true north) or M (magnetic north) after the field name. To configure the north reference, use the Units form.	0.00°
Horizontal distance	enter the two-dimensional distance to the feature, ignoring any difference in height between your position and the feature.	0.00 m
Vertical distance	enter the vertical distance between your position and the feature.	0.00 m
Slope distance	enter the distance from your position to the feature, including any difference in height.	0.00 m
Inclination	enter the angle of inclination between your position and the feature.	0.00°



Distance-Distance Offset form

 **Data / Collect Features / Create / Options / Offset** or

 **Data / Update Features / Begin / Options / Offset**

When you select the Distance-Distance option in the **Point offset type form**, the Distance-Distance Offset form appears:

When you set a distance-distance offset, you record two reference positions (A and B), and the distance from each of these positions to the feature. For more information, see **Distance-distance offset**.

To increase accuracy, you can record each reference position as if it were an averaged vertex. If you log a number of positions at each reference point, TerraSync averages these positions to give a more accurate reference position.

[More...](#)



To record the offset you need to perform a number of steps in a particular sequence. To ensure that the correct steps are followed, the form displays instructions and hides some fields until you have performed the preceding steps. For more information, see **Offsets**.

The Distance-Distance Offset form contains the following:

- **Next**
- **Clear**
- **Direction**

The Distance-Distance Offset form also contains the following fields for each reference position:

- **Reference position**
- **Distance**

Use this button ...	to ...
Next	move to the next step in the sequence. When you have completed all steps, this button is replaced with the OK button.
Clear	delete all the offset and position data that you have recorded for this feature.

[More...](#)



Use this field ...	to ...	Default value
Reference position	check the status of the reference position. This field is read-only. The options are: <ul style="list-style-type: none"> • Not started You have not yet collected any positions, because logging was paused when you opened the form. • Logging TerraSync is logging positions for this reference position. • Paused Logging of positions is paused. • Collected The position has been collected. 	(none)
Distance	specify the distance from the reference position to the feature. Depending on the current Offset Format , the fields below this heading are either Horizontal distance and Vertical distance , or Slope distance and Inclination .	
Direction	specify the feature's direction relative to the path between the reference positions. The options are: <ul style="list-style-type: none"> • Left • Right 	?



Triple Distance Offset form

Data / Collect Features / Create / Options / Offset or

Data / Update Features / Begin / Options / Offset

When you select the Triple Distance option in the **Point offset type form**, the Triple-Distance Offset form appears:

When you set a triple distance offset, you record three reference positions (A, B, and C), and the distance from each of these positions to the feature. A triple distance offset is similar to a distance-distance offset, but a third measurement provides some mathematical redundancy so that the direction can be calculated automatically. For more information, see **Triple distance offset**.

More...



To increase accuracy, you can record each reference position as if it were an averaged vertex. If you log a number of positions at each reference point, TerraSync averages these positions to give a more accurate reference position.

To record the offset you need to perform a number of steps in a particular sequence. To ensure that the correct steps are followed, the form displays instructions and hides some fields until you have performed the preceding steps. For more information, see **Offsets**.

The Triple Distance Offset form contains the same controls as the **Distance-Distance Offset form**, except that the repeated fields appear three times (for the three reference positions A, B, and C), and the Direction field is usually read-only because the software calculates it automatically.



Bearing-Bearing Offset form

 **Data / Collect Features / Create / Options / Offset** or

 **Data / Update Features / Begin / Options / Offset**

When you select the Bearing-Bearing option in the **Point offset type form**, the Bearing-Bearing Offset form appears:

When you set a bearing-bearing offset, you record two reference positions (A and B), and the bearing from north from each of these positions to the feature. For more information, see **Bearing-bearing offset**.

To increase accuracy, you can record each reference position as if it were an averaged vertex. If you log a number of positions at each reference point, TerraSync averages these positions to give a more accurate reference position.

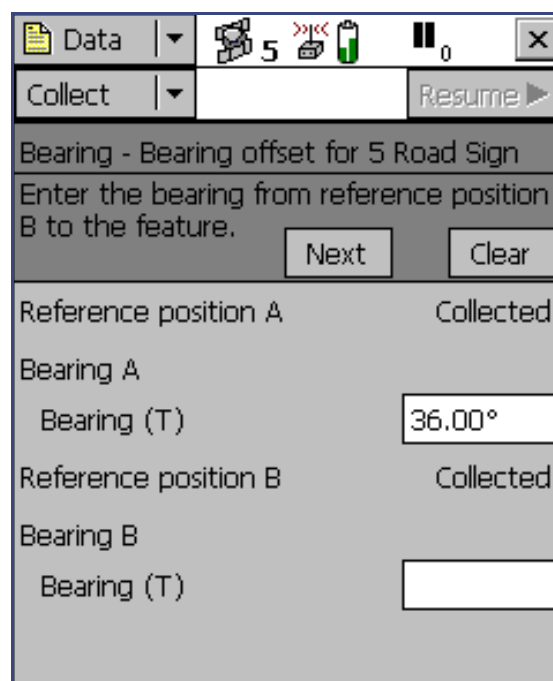

Bearing - Bearing offset for 5 Road Sign	
Enter the bearing from reference position B to the feature.	
Next	Clear
Reference position A	Collected
Bearing A	
Bearing (T)	36.00°
Reference position B	Collected
Bearing B	
Bearing (T)	

More...



To record the offset you need to perform a number of steps in a particular sequence. To ensure that the correct steps are followed, the form displays instructions and hides some fields until you have performed the preceding steps. For more information, see **Offsets**.

The Bearing-Bearing Offset form contains the following buttons:

- **Next**
- **Clear**

The Bearing-Bearing Offset form contains the following fields for each reference position:

- **Reference position**
- **Bearing**

Use this button ...	to ...
Next	move to the next step in the sequence. When you have completed all steps, this button is replaced with the OK button.
Clear	delete all the offset and position data that you have recorded for this feature.



Use this field ...	to ...	Default value
Reference position	check the status of the reference position. This field is read-only. The options are as for the Reference position field in the Distance-Distance Offset form .	(none)
Bearing	enter the bearing, in the selected angle units, from the reference position A to the feature. For example, if you are facing north and the feature is directly to your right (east), enter 90°. The angle you enter is relative to the configured north reference, which is indicated by a T (true north) or M (magnetic north) after the field name. To configure the north reference, use the Units form.	0.00°



Triple Bearing Offset form

 Data / Collect Features / Create / Options / Offset or

 Data / Update Features / Begin / Options / Offset

When you select the Triple Bearing option in the **Point offset type form**, the Triple Bearing Offset form appears:

When you set a triple bearing offset, you record three reference positions (A, B, and C), and the bearing from north from each of these positions to the feature. A triple bearing offset is similar to a bearing-bearing offset, but a third measurement provides some mathematical redundancy that can improve accuracy. For more information, see **Triple bearing offset**.

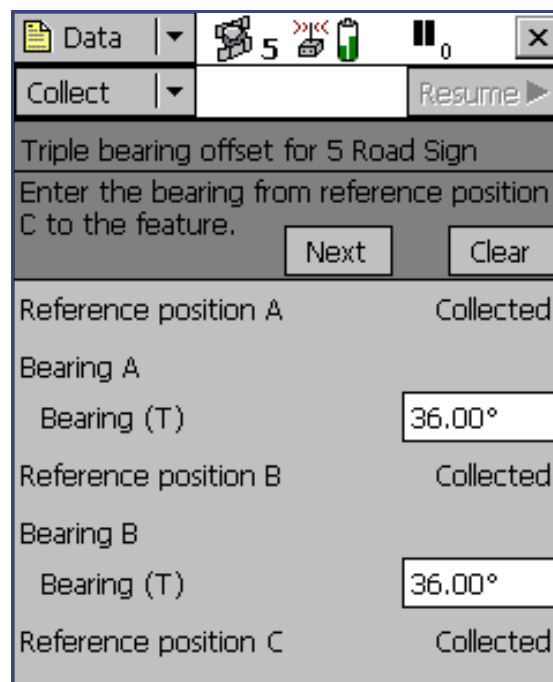

Reference position	Status
Reference position A	Collected
Bearing A	
Bearing (T)	36.00°
Reference position B	Collected
Bearing B	
Bearing (T)	36.00°
Reference position C	Collected

More...



To increase accuracy, you can record each reference position as if it were an averaged vertex. If you log a number of positions at each reference point, TerraSync averages these positions to give a more accurate reference position.

To record the offset you need to perform a number of steps in a particular sequence. To ensure that the correct steps are followed, the form displays instructions and hides some fields until you have performed the preceding steps. For more information, see **Offsets**.

The Triple Bearing Offset form contains the same buttons and fields as the **Bearing-Bearing Offset form**, except that the repeated fields appear three times (for the three reference positions A, B, and C).



Vertex form

 **Data / Collect Features / Create / Options / New Vertex or**

 **Data / Update Features / Begin / Options / New Vertex**

When you select the New Vertex option from the **Attribute entry form** the Vertex form appears:

The Vertex form looks exactly like the **Attribute entry form**, except that the messages **Vertex # open** (where # represents the vertex number within the current feature) and **Remain stationary** appear in the form title.

When you log an averaged vertex for a line or area feature, the TerraSync software records several positions at each vertex, then averages these positions together to calculate the vertex position. The averaged position is more accurate than a single position.

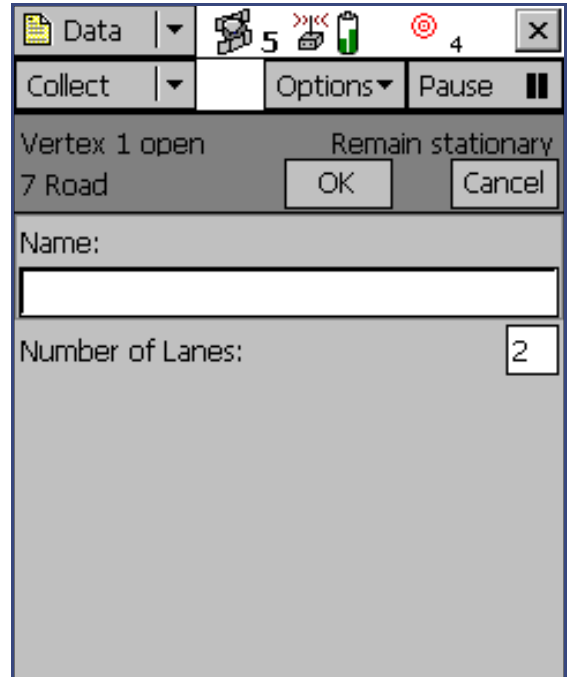

The screenshot shows the Vertex form interface. At the top, there is a status bar with a 'Data' menu, a 'Collect' menu, and icons for 'Options' and 'Pause'. Below this, the form title reads 'Vertex 1 open' and 'Remain stationary', with 'OK' and 'Cancel' buttons. The main area contains a 'Name:' label followed by an empty text input field, and a 'Number of Lanes:' label followed by a text input field containing the number '2'.

More...



To record an averaged vertex, open the attribute entry form, tap **Options**, and select New Vertex. Logging begins, the logging icon in the status bar changes to an animated circle zooming in , and the number beside it shows the number of positions logged for this vertex. Remain stationary at your current location and enter or edit attribute values if necessary. When you have recorded enough positions for this vertex, tap **OK** to close the Vertex form and return to the attribute entry form.

TIP If you want your line or area feature to contain only averaged vertices, use the **Log Later** function to pause logging before opening the feature. When you open the Vertex form, logging resumes automatically, and when you close the vertex, logging returns to the paused state. This ensures that you do not record any positions that are not associated with a vertex.

For more information, see **Recording averaged vertices**.



Logging interval form

 Data / Collect Features/Update Features / Options / Logging interval or

 Data / Collect Features / Options / Create / Logging interval or

 Data / Update Features / Options / Begin / Logging interval

You can open the Logging interval form from any of the following screens:

- **Collect Features** screen
- **Update Features** screen
- **Attribute entry form** (when logging a new feature)
- **Attribute entry form** (when updating an existing feature)

The same form appears, regardless of which screen you open it from. Any changes you make apply to the open data file throughout the software.

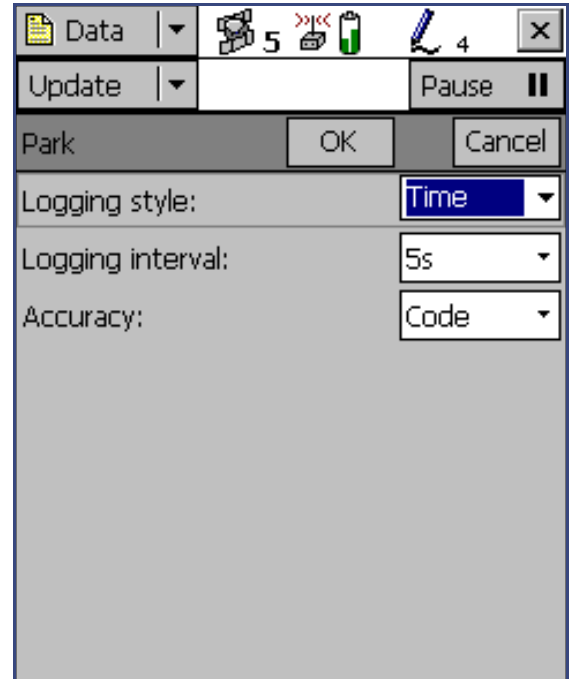

[More...](#)



TIP The logging interval is only for the highlighted or open feature type. However, you can configure logging intervals for all feature types in the open data file from the **Logging Settings** form in the Setup section.

To open the Logging interval form, tap **Options** in one of these screens, then select Logging interval.

In this form you can change the interval for all features of the type you have selected. A default logging interval for each type of feature is set in the data dictionary.

NOTE Any changes you make in this form are applied to **all** features of the selected type that you collect or update in the open data file.

The Logging interval form contains the following fields:

- **Logging style**
- **Logging interval**
- **Accuracy**

[More...](#)



Use this field ...	to ...	Default value
Logging style	<p>choose which unit of measurement to set the logging interval in.</p> <p>The options are:</p> <ul style="list-style-type: none"> • Time log a new position when a certain time since logging the last position for this feature has elapsed. • Distance log a new position when you have moved a certain distance from the last position logged for this feature. <p>NOTE This field is only available for line and area features. If the selected feature is a point, this field displays Time and the logging style cannot be edited.</p>	Time



Use this field ...	to ...	Default value
Logging interval	<p>enter the time or distance between recording GPS positions. You must enter the interval in the units specified in the Logging style field.</p> <p>TIP When the logging interval is small, the TerraSync software records more positions for the feature, but requires more storage space.</p> <p>If you do not want to log positions, select Off. No GPS data is recorded for this feature.</p>	5 s
Accuracy	<p>specify whether to log the usual code phase data from the GPS receiver, or to log more detailed but more accurate carrier phase data.</p>	Code



Continue feature form

Data / Collect Features / Options / Continue

When you select the Continue option from the **Collect Features** form, the Continue feature form appears:

This form displays a list of line and area features that can be continued. To continue a feature, select it from the list and tap **Continue**. The **Attribute entry form** for the selected feature appears, and logging of GPS positions to this feature resumes.

For more information, see **Continuing line and area features**.

This screen contains the following:

- **File**
- **Cancel**
- **Choose Feature list**
- **Continue**
- **Labels**

#	Name	Distance
4	Park	57.10 m
5	Road	32.54 m

Positions: 7
Date Visited: 10/12/00
Type: Speed Limit

[More...](#)



Use this button ...	to ...
Cancel	return to the Collect Features screen without continuing a feature.
Continue	open the selected feature on the list to continue logging positions to it. When you tap Continue the attribute entry form for the selected feature appears.

Use this field ...	to ...
File	check the filename of the open file. This field is read-only.
Choose Feature list	select the feature you want to review or update. The list contains the following columns: <ul style="list-style-type: none"> • # the feature identification number. Each feature is given a unique number in the file. • Name the name of the feature and its type, shown by the line or area icon to the left of the feature name.

[More...](#)



Use this field ...	to ...
Labels	check that you have selected the correct feature in the list. The labels show the name and value of two attributes from the selected feature. The data dictionary defines which attributes from each feature type are selected as labels.



Existing File

Data / Existing File

NOTE You cannot open imported files using the **TerraSync Standard edition software**. Imported files do not appear in the Existing File subsection.

To open the Existing File subsection, tap the Subsection list button and choose Existing File. The Existing File screen appears:

Use the Existing File subsection to open an existing data file.

This screen contains the following:

- **List of files**
- **Positions**
- **DD**
- **Features**
- **Status**

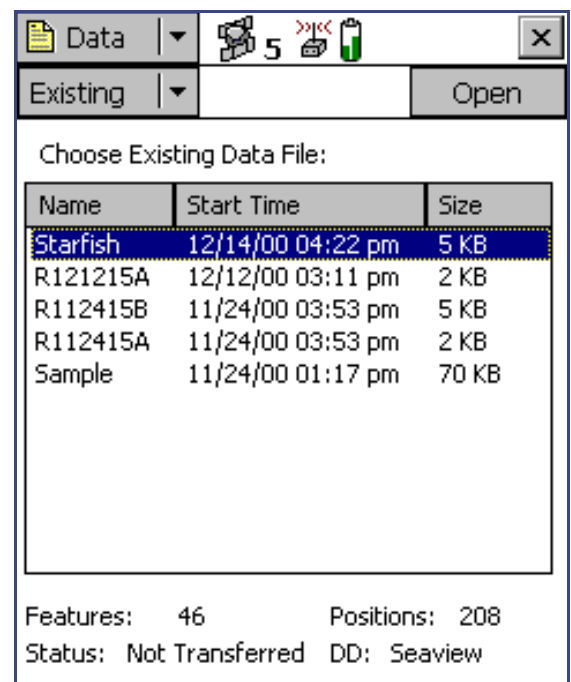

More...



When you have selected an existing data file from the list of files, tap **Open** to open this file and begin reviewing existing features in the **Update Features** screen.

NOTE This section is not available if a file is already open. To access this section, close the file.

TIP You can also switch to the **Collect Features** screen to add new features to the file. However, because of the way in which GPS times are stored, you cannot log new features to a file that is more than a week old. To maintain accurate storage, it is necessary to limit the time-span of a data file to seven days.



Field	Description
List of files	<p>A list of all the data files that are available for update. The list contains the following columns:</p> <ul style="list-style-type: none">• Name the name of the data file.• Time the date and time when the file was created or was last updated.• Size the size of the file. <p>You can drag each column heading to resize the column, or tap a column heading to sort by that column. If the list is already sorted by the column you tap, the sort order reverses.</p> <p>To open a file, highlight it in this list and tap Open. The Update Features screen appears.</p>
Features	The number of features in the selected file.
Positions	The number of position records in the selected file.



Field	Description
Status	<p>The update status of the selected file. It is one of the following:</p> <ul style="list-style-type: none"> • Transferred the file has been created or updated in the TerraSync software, has been copied to your office computer, and has not been updated in TerraSync since. • Not Transferred the file has not been copied to your office computer since it was created or last updated. • Imported the file has been transferred from your office computer, imported from Shapefiles, or received by e-mail, but has not been updated in the TerraSync software yet. <p>NOTE If you are using the TerraSync Standard edition software, files with the status Imported do not appear in this list, because they cannot be opened.</p>
DD	The data dictionary the selected file is associated with. When you create a file you associate it with a particular data dictionary. Once you have created a file, you cannot change which data dictionary it uses.



Update Features

Data / Update Features

NOTE You cannot open imported files using the **TerraSync Standard edition software**.

To open the Update Features subsection, tap the Subsection list button and select Update Features.

Use this subsection to review and maintain features and attributes you have already collected. You can update attributes, offsets, and GPS positions, or delete features. The Update Features screen lists all the features in the open data file.

You can also tap **Options** to display the **Update Features option list**.

To update a feature, highlight it in the Choose Feature list and tap **Begin**. An attribute entry form appears.

NOTE This subsection is only available when a file is open. Use the **Existing File** screen to open an existing data file, or the **New File** screen to open a new data file.

#	Name			Distance
1	Road Sign	<input checked="" type="checkbox"/>		7.22 m
2	Road Sign	<input type="checkbox"/>		1.09 m
3	Road	<input type="checkbox"/>		32.54 m
4	Park	<input type="checkbox"/>		57.10 m

More...





This screen contains the following:

- **File**
- **Positions**
- **(3D)**
- **Begin**
- **Carrier coverage**
- **Area**
- **Choose Feature list**
- **Length (2D)**
- **Labels**

Use this button ...	to ...
Begin	open the selected feature on the list for update. When you tap Begin the attribute entry form for the selected feature appears.

Use this field ...	to ...
File	check the filename of the open file. This field is read-only.



Use this field ...	to ...
Choose Feature list	<p>select the feature you want to review or update. The list contains the following columns:</p> <ul style="list-style-type: none"> • # the feature identification number. Each feature is given a unique number in the file. • Name the name of the feature and its type, shown by the point, line, or area icon to the left of the feature name • Update the Update status of the feature: <ul style="list-style-type: none"> • (blank) the feature is new. •  the feature has been imported from GPS Pathfinder Office. •  the feature has been updated. • Filter the filter status of the feature: <ul style="list-style-type: none"> • (blank) the feature does not meet the criteria of the filter, or no filter has been set. •  the feature meets the filter criteria. • Distance the distance from the feature to the GPS position.



Use this field ...	to ...
Positions	view the number of GPS and digitized positions recorded for the selected feature in the list.
Carrier coverage	<p>view the carrier phase status of the selected feature. This field only appears if the selected feature has carrier phase data collection enabled.</p> <p>Possible values are:</p> <ul style="list-style-type: none"> • <carrier time> enough carrier data has been collected for this feature. This field shows the length of the block, in mm:ss format. • Continuing the carrier block that this feature belongs to is still being collected, and may provide enough carrier data to process this feature. • Insufficient not enough carrier data has been collected for this feature.



Use this field ...	to ...
Length (2D)	view the two-dimensional length of the selected feature. This field only appears if the selected feature is a line or area feature. The two-dimensional length is calculated by adding together the horizontal distances between positions logged for the feature, ignoring height information.
(3D)	view the three-dimensional length of the selected feature. This field only appears if the selected feature is a line feature. The three-dimensional length takes the height of each position in the feature into account when it calculates distances between positions.
Area	view the (two-dimensional) area of the feature. This field only appears if the selected feature is an area feature.
Labels	check that you have selected the correct feature in the list. The labels show the name and value of two attributes from the selected feature. The data dictionary defines which attributes from each feature type are selected as labels.



Attribute entry form

Data / Update Features / Begin

To update a feature, highlight it in the Choose Feature list and tap **Begin**. Alternatively, double-tap the feature in the Map screen. An attribute entry form appears:

Use the form to edit the attribute values for the feature. You can also tap **Options** to display the **Feature option list**.

TIP To update a feature without changing its attribute values or position information, select the Mark as updated check box. For more information, see **Marking a feature as updated**.

To edit the value for an attribute, select the field on the form. The method of data entry you use will depend on the availability of physical or virtual keyboards, and on the type of field selected. To finish data entry on a field, either select another field or use the Enter key on the real or virtual keyboard to move to the next field.

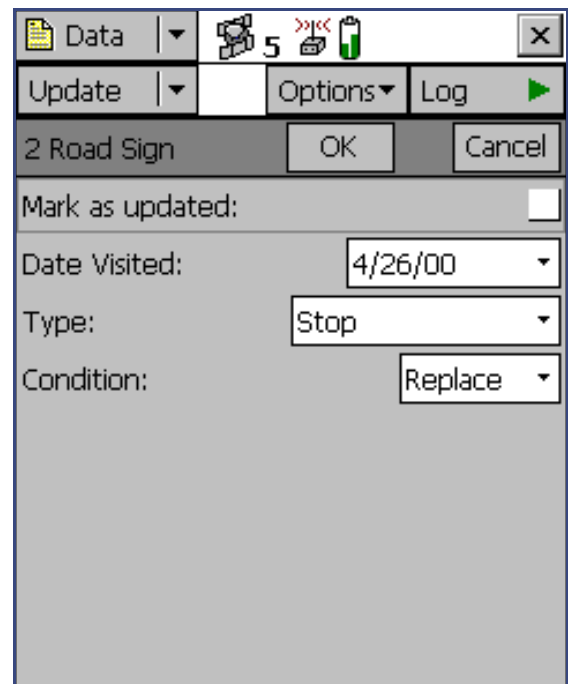

The screenshot shows the attribute entry form for a feature named "2 Road Sign". At the top, there is a "Data" dropdown menu, a "5" icon, and a battery level indicator. Below this is a bar with "Update" and "Options" dropdown menus, and a "Log" button with a green play icon. The feature name "2 Road Sign" is displayed, followed by "OK" and "Cancel" buttons. The form contains several fields: "Mark as updated:" with a checkbox, "Date Visited:" with a date picker set to "4/26/00", "Type:" with a dropdown menu set to "Stop", and "Condition:" with a dropdown menu set to "Replace".

More...



For more information on data entry techniques, see **Data entry**.

When you have edited the attribute data or marked the feature as updated, tap **OK**. The updated information is stored and the **Update Features** screen reappears. A  appears next to the feature name in the Choose Feature list. This indicates that the feature has been updated.

To abandon a feature, tap **Cancel**. You are prompted to confirm this cancellation.

Use **Log** to start, pause, or resume logging of GPS positions. By default, when you update an existing feature, new GPS positions are not logged, so logging is paused when you first open the feature for update. For more information, see **Pausing and resuming logging**.



Update status

Each feature in a data file has an update status. You can use the update status to sort or filter features in the field, so you can tell which features are new, which you have visited for data maintenance, and which you have not visited yet. In the GPS Pathfinder Office software you can use the update status to select features to export to your GIS.

The Update column of the **Choose Feature list** in the **Update Features** screen shows the status of each feature:

Icon	Update status	Description
(blank)	New	The feature has been created since the file was transferred from GPS Pathfinder Office, or the feature is in a new file that has never been transferred to GPS Pathfinder Office.
○	Imported	The feature has been transferred from GPS Pathfinder Office but has not been updated yet.
☑	Updated	The feature has been transferred from GPS Pathfinder Office and has been updated since the transfer.



When you transfer a data file from GPS Pathfinder Office to the TerraSync software, each feature in the file is given the update status Imported.

When you create a feature in the TerraSync software, it is given the update status New.

When you change an Imported feature in any way, its update status changes to Updated. Any of the following actions automatically changes a feature's status to Updated:

- Changing attribute values in the **Attribute entry form**
- **Marking a feature as updated** in the attribute entry form
- **Updating positions** with the **Log** button
- **Digitizing** positions
- Changing offset values in an offset form

NOTE When you edit a New feature, its status does not change to Updated. The update status indicates the feature's status with respect to GPS Pathfinder Office and your GIS.



Marking a feature as updated

When you change an existing feature's attribute values, offset data, or GPS position, its **Update status** changes to Updated. When you are visiting features for data maintenance, you can use the update status to identify the features you have not visited yet.

Sometimes you may want to indicate that you have visited a feature and checked its position and attributes, without making any changes to the values stored. You can do this by selecting the Mark as updated check box in the attribute entry form. The feature's status changes to Updated and the updated icon () appears beside it in the **Choose Feature list**.

If the feature has a date attribute that is set in the data dictionary to Auto Generate on Update, the date attribute's value automatically changes to the current date. No other changes to the feature information occur.

TIP After you have marked a feature as updated, you can still change its attributes or position information as usual. However, once you change attribute values or position information, you cannot unmark the feature.



Updating positions

To update the position information for a feature, select it from the **Choose Feature list** and tap **Begin**. The attribute entry form appears. Tap **Log**.

If the **Allow Position Update** field in the Setup section is configured to require confirmation, or the feature is a line or area, a dialog appears, asking you to select a logging option:

Use this option ...	to ...
Update feature (Replace)	record new positions for this feature, replacing all positions This option is always available.
Continue feature (Append)	continue the feature, appending the new positions to the existing positions. For more information, see Continuing line and area features . This option is not available if the feature is a point feature.

If you tap **OK** in this dialog, TerraSync starts logging GPS data (either replacing or appending to existing positions, depending on the option you selected). If you tap **Cancel**, the dialog closes and no GPS data is logged.



When you have finished collecting positions for a feature, tap **OK**. The updated information is stored and the **Update Features** screen reappears. The updated icon () appears next to the feature in the Choose Feature list to indicate that it is updated.

NOTE If you log new or additional position information for a feature, and that feature is currently selected as the navigation target, you cannot navigate to the new position until you reselect the feature as the navigation target.

TIP You can also use **Digitizing** to update a feature's positions.



Update Features option list

Data / Update Features / Options

In the **Update Features** screen, tap **Options** to display the available options.

The options are:





- **Show Filtered Features**
- **Show Unfiltered Features**
- **Filter**
- **Delete**
- **Undelete**
- **Set Nav Target**
- **Clear Nav Target**
- **Logging interval**
- **Continue**



Use this option ...	to ...
Show Filtered Features	display filtered features in the Choose Feature list and on the map. Filtered features are indicated by  in the Filter column. When filtered features are displayed, this option has a check mark (✓) beside it.
Show Unfiltered Features	display unfiltered features in the Choose Feature list and on the map. Unfiltered features are indicated by a blank in the Filter column. When unfiltered features are displayed, this option has a check mark (✓) beside it.
Filter	open the Filter By form where you can set or clear filtering conditions.
Delete	delete the selected feature in the Choose Feature list. A deleted feature is indicated by a horizontal line through it. Deleted features can be undeleted in the TerraSync software or in the GPS Pathfinder Office software.
Undelete	undelete the selected feature. The line through the feature is removed. This option is only available if the selected feature is deleted.

More...



Use this option ...	to ...
Set Nav Target	set the currently selected feature as the navigation target. When you set the target, the point  , line  , or area  icon beside the selected feature is replaced by the target icon  . If there was already a navigation target selected, its icon changes from the target icon back to its usual point, line, or area icon.
Clear Nav Target	TIP You can also set the navigation target in the Map section. clear the navigation target. You can use this option even when the selected feature in the list is not the navigation target. When you clear the target, the target icon  beside the existing navigation target is replaced by the feature's usual point, line, or area icon.
Logging interval	open the Logging interval form where you can configure the logging interval for all features of the selected type in the open data file.
Continue	resume logging a line or area feature that you logged previously. For more information, see Continuing line and area features .



Filter By form

Data / Update Features / Options / Filter

When you select the Filter option from the **Update Features option list**, the Filter By form appears:

In this form you can set filters that divide features into two groups: **filtered** and **unfiltered**. Once you have applied a filter, you can hide or show either group in the Data section or in **The Map section**. You can also sort features by their filter status.

NOTE Any filter you apply in the Data section applies throughout the TerraSync software while the current data file remains open.

For more information on filtering, see **Filtering features**.

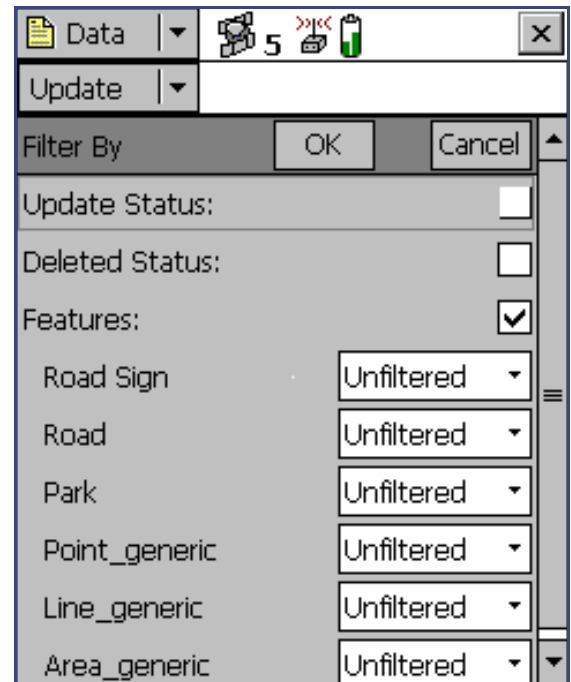

[More...](#)



The Filter By form contains the following fields:

- **Update Status**
- **Deleted Status**
- **Features**

Use this field ...	to ...
Update Status	<p>specify whether to filter by update status. If this check box is selected, the following fields appear below it:</p> <ul style="list-style-type: none"> • New • Imported • Updated <p>Use these fields to specify update status filtering conditions. If this check box is cleared, the New, Imported, and Updated fields do not appear and the filter does not select by update status.</p>

[More...](#)



Use this field ...	to ...
Deleted Status	<p>specify whether to filter by deletion status. If this check box is selected, the following fields appear below it:</p> <ul style="list-style-type: none"> • Deleted • Undeleted <p>Use these fields to specify deletion status filtering conditions. If this check box is cleared, the Deleted and Undeleted fields do not appear and the filter does not select by deletion status.</p>



Use this field ...	to ...
Features	<p>specify whether to filter by feature types or their attributes. If this check box is selected, a field for each type of feature in the data dictionary appears below it. Use these fields to specify feature filtering conditions.</p> <p>Each feature type field contains the following options:</p> <ul style="list-style-type: none"> • Unfiltered do not filter by this feature type. • All Filtered filter all features of this type. • Filter By select features of this type to filter by, using attribute values. When you select this option, the Attribute, Test, and Value fields appear below this field. Use these three fields to select the attribute values to filter by for this feature only. <p>If this check box is cleared, the feature type fields do not appear and the file is not filtered by feature type or attribute values.</p>



If the Update Status check box is selected, the following fields appear below it:

- **New**
- **Imported**
- **Updated**

Use this field ...	to ...	Default value
New	specify whether to filter New features. The options are: <ul style="list-style-type: none"> • Unfiltered do not filter new features. • Filtered filter new features. 	Unfiltered
Imported	specify whether to filter Imported features. The options are: <ul style="list-style-type: none"> • Unfiltered do not filter imported features. • Filtered filter imported features. 	Unfiltered
Updated	specify whether to filter Updated features. The options are: <ul style="list-style-type: none"> • Unfiltered do not filter updated features. • Filtered filter updated features. 	Unfiltered

[More...](#)



If the Deleted Status check box is selected, the following fields appear below it:

- **Deleted**
- **Undeleted**

Use this field ...	to ...	Default value
Deleted	specify whether to filter deleted features. The options are: <ul style="list-style-type: none"> • Unfiltered do not filter deleted features. • Filtered filter deleted features. 	Unfiltered
Undeleted	specify whether to filter undeleted features. The options are: <ul style="list-style-type: none"> • Unfiltered do not filter undeleted features. • Filtered filter undeleted features. 	Unfiltered

[More...](#)



If the Features check box is selected and Filter By is selected in a feature type field, the following fields appear below the feature type field:

- **Attribute**
- **Test**
- **Value**

Use this field ...	to ...
Attribute	select the attribute from the feature type to filter by. Each attribute of the feature type is listed here.
Test	select the comparison to perform on the attribute selected above. The options listed depend on the attribute type: <ul style="list-style-type: none"> • Menu Equal To, Not Equal To • Text or filename Containing, Not Containing • Date, time, or numeric Equal To, Not Equal To, Less Than, Greater Than
Value	select the attribute value to filter by. Select the attribute value from the list of options if the attribute type is menu, or enter the value to filter by.



Filtering features

The TerraSync software lets you filter each feature by one attribute value. However, a filter can include conditions for each feature type, as well as each deletion status or update status. You can set complex filtering conditions with a single filter, or you can select just one condition to filter.

When you apply a filter, all features are divided into two groups: filtered and unfiltered. The software does not automatically hide or show either group; it is up to you to decide which group you want to view and which, if any, you want to hide.

To define a filter, tap **Options** in the **Update Features** screen (or **The Map section**) and select Filter. The **Filter By form** appears.

The Filter By form lets you define conditions on each feature's update status, deletion status, and feature type. You can set any or all of these filters. By default, no filtering is applied.

The filter functions like a sieve. All features that satisfy the conditions you specify are moved to the filtered group. The others remain in the unfiltered group. If you want to separate a small group of features from the rest, set them to be filtered.

You can set any or all of these filters at the same time. When you set more than one filtering condition, **all** conditions must be met for a feature to be filtered. For example if you have chosen to filter deleted features that have been updated, a feature must be **both** updated **and** deleted to be included in the filtered group. If it does not meet all the conditions you set, it is grouped in the unfiltered group.

[More...](#)



To set a filter on each feature's update status, select the Update Status check box. The New, Imported, and Updated fields appear below the check box. Select the appropriate value in each field to specify filtering conditions. For example, to filter new and updated features, select Filtered in the New field and in the Updated field:

Similarly, to set a filter on each feature's deletion status, select the Deleted Status check box. The Deleted and Undeleted fields appear below the check box. Select the appropriate value in each field to specify filtering conditions.

To set a filter on feature properties, select the Features check box. A field for each feature type in the data dictionary appears in the Filter By form. By default, each of these fields is set to the Unfiltered option, so no features are selected.

If you select All Filtered from a feature type field, all features of that type are included in the filter. If you select Unfiltered, no features of this type are included. If you select Filter By, you can filter this feature type according to its attribute values.



[More...](#)

When you select Filter By in a feature type field, the Attribute, Test, and Value fields appear below it. To filter by attribute, select the attribute name from the Attribute field, select a comparison operation from the Test field, and enter or select a value in the Value field.

When you apply the filter, a feature of this type is filtered if the value in the selected attribute matches the value and comparison in the filter. For example, if you specify that the Date Visited attribute must be less than 1 January 2000, any feature visited on or before 31 December 1999 is filtered. Features visited on or after 1 January 2000 are grouped as unfiltered.

You can apply different levels of filtering to different feature types. For example you could select All Filtered for the Road and Park feature types, but specify an attribute condition for the Road Sign feature type. When you apply the filter, all of the Road and Park features, and some of the Road Sign features, are filtered, and the other Road Sign features are unfiltered.



[More...](#)

To apply a filter, simply tap **OK** in the Filter By form. The form closes and the filter icon  appears in the **Status bar**. Each feature in the **Update Features** screen that is filtered has a filter icon  beside it. Unfiltered features have no icon.

NOTE Any filter you use applies as long as the current data file remains open, and is cleared when you close the file.

Once a filter is active, you can tap the Filter column heading to sort the list by filter status. Filtered features are grouped first, followed by unfiltered features. Tap the column heading again to reverse the sort order, listing unfiltered features first.

Use the **Show Filtered Features** and **Show Unfiltered Features** options in the Update Features screen to hide or show the two groups of features. When you hide or show a group of features in the Data section, the corresponding map layer is hidden or shown. Similarly, when you hide or show features in the Map section, they are hidden or shown in the Data section. For more information, see **Map layers**.

NOTE Deleted features are never displayed on the map.

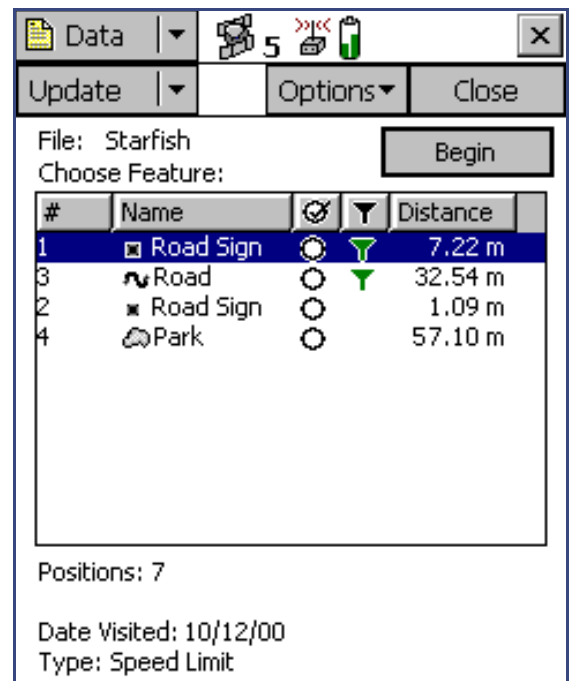

File Manager

Data / File Manager

To open the File Manager subsection, tap the Subsection list button and select File Manager. You can use this subsection to:

- copy or move files between the main memory and storage cards, or between disk drives
- delete or rename files
- e-mail files

Select the file you want, then tap **Options** and select a command from the **File Manager option list**.

This screen contains the following:

- **Choose File**
- **Location**
- **List of files**
- **Features**
- **Positions**
- **Status**
- **DD**

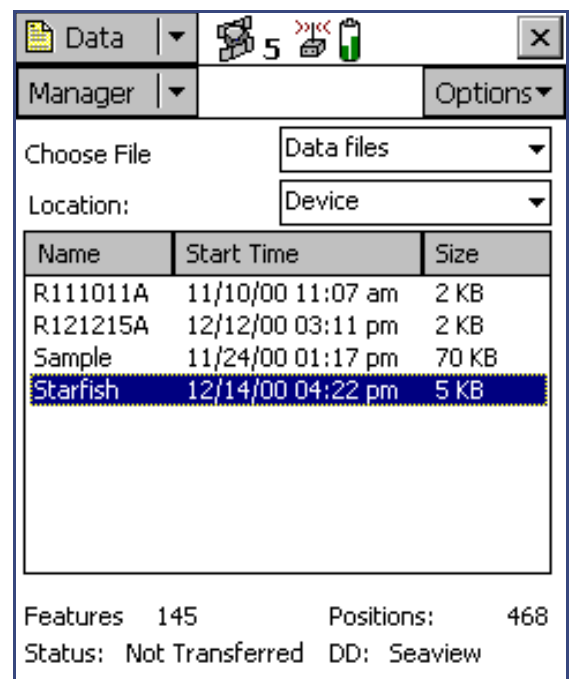

More...



Use this field ...	to ...	Default value
Choose File	<p>select the type of file to display. The options are:</p> <ul style="list-style-type: none"> • Data files SSF files (.cor, .imp, .phs, or .ssf files) containing feature and attribute information • Dictionaries data dictionary (.ddf) files containing feature definitions • Background files vector (.cor, .imp, .phs, .ssf) or raster (.bmp, .jpg, .sid) background files. • Geoid files files containing geoid definitions • Configuration files .tcf files containing TerraSync configuration information 	Data files

More...



Use this field ...	to ...	Default value
Location	<p>select the storage location to display files from. The options are:</p> <ul style="list-style-type: none"> • Device the main memory of your CE device. • Card a storage card connected to the CE device. If you have more than one card connected, there is a numbered option for each card (Card 1, Card 2, and so on). • (Drive letter) a disk drive on the PC. If the PC has more than one writable disk drive, there is an option for each drive (A:, C:, and so on). 	Device <i>or</i> C:

More...



Use this field ...	to ...	Default value
List of files	<p>select the file you want to move, copy, rename, delete, or export to Shapefiles. The list contains the following columns:</p> <ul style="list-style-type: none"> • Name the name of the file • Start Time the date and time when the file was created or last updated • Format the file format of the background file. This column appears instead of the Start Time column when Background files is selected in the Choose File field. • Size the size of the file, in kilobytes <p>You can drag a column heading to resize the column, or tap a column heading to sort by that column. If the list is already sorted by the column you select, the sort order</p>	(no default)



Use this field ...	to ...	Default value
Features	view the number of features in the selected file. This field is blank if Data files is not selected in the Choose File Type list.	(no default)
Positions	view the number of position records in the file. This field is blank if Data files is not selected in the Choose File Type list.	(no default)



Use this field ...	to ...	Default value
Status	<p>view the update status of the selected file. It is one of the following:</p> <ul style="list-style-type: none"> • Transferred the file has been created or updated in the TerraSync software, has been copied to your office computer, and has not been updated in TerraSync since. • Not Transferred the file has not been copied to your office computer since it was created or last updated. • Imported the file has been transferred from your office computer, imported from Shapefiles, or received by e-mail, but has not been updated in the TerraSync software yet. • Not Usable the file's status is Imported, but you are using the TerraSync Standard edition software so you cannot update it. 	(no default)

More...



Use this field ...	to ...	Default value
DD	<p>view the name of the data dictionary associated with the selected file.</p> <p>This field is blank if Data files or Dictionaries is not selected in the Choose File Type list.</p>	(no default)



File Manager option list

Data / File Manager / Options

In the File Manager screen, tap **Options** to display the available options.

To use a File Manager option, highlight the file in the **List of files** that you want, tap **Options**, and select the option you want. The options are:

- **Delete**
- **Rename**
- **Send via E-mail**
- **New dictionary**
- **Write data to Shape**
- **Copy to Card/A:**
- **Move to Card/A:**
- **Receive via E-mail**
- **Read dictionary from data**
- **Copy to Device/C:**
- **Move to Device/C:**
- **Edit dictionary**
- **Read data from Shape**

NOTE The options that are available depend on the selected file type, the TerraSync software edition (Professional or Standard) that is installed, and the storage locations that are available on your field computer.



Use this option ...	to ...
Delete	delete the highlighted file.
Copy to Card/A:	make a copy of the highlighted file in the main memory or hard drive, and store that copy on a storage card or removable disk in your field computer. NOTE The drive letter matches the drive letter of the removable disk. Usually the drive letter is A:. NOTE This option is only available if there is a storage card or removable disk in your field computer and you selected Device or C: from the Location field.
Copy to Device/C:	make a copy of the highlighted file on the storage card or removable disk and store that copy in the main memory or hard drive of your field computer. NOTE This option is only available if there is a storage card or removable disk in your field computer, and you selected Card or A: from the Location field.
Rename	change the name of the highlighted file.



Use this option ...	to ...
Move to Card/A:	<p>move the highlighted file from the main memory or hard drive to a storage card or removable disk in your field computer.</p> <p>NOTE This option is only available if there is a storage card or removable disk in your field computer and you selected Device or C: from the Location field.</p>
Move to Device/C:	<p>move the highlighted file from a storage card or removable disk in your field computer to the main memory or hard drive.</p> <p>NOTE This option is only available if there is a storage card or removable disk in your field computer and you selected Card or A: from the Location field.</p>
Send via E-mail	open the Send via E-mail form .
Receive via E-mail	open the Receive via E-mail form .



Use this option ...	to ...
Edit dictionary	<p>open the Edit dictionary form, where you can update the selected data dictionary, or the data dictionary embedded in the selected data file.</p> <p>If you edit a data dictionary, the changes will affect all data files that you create using this data dictionary. Changes will not affect data files already created using this data dictionary.</p> <p>If you edit a data file's embedded dictionary, the changes affect only this data file, not the data dictionary that was used when the file was created.</p>
New dictionary	open the New dictionary form , where you can specify a name for the new data dictionary.
Read dictionary from data	open the Read dictionary from data form .
Read data from Shape	open the Read from Shape form . The name of this option and the name of the form depend on the file type that is selected in the Choose File field.
Write data to Shape	open the Write to Shape form .



Send via E-mail form

Data / File Manager / Options / Send via E-mail

NOTE This option is only available on field computers that have e-mail support.

When you select the Send via E-mail option from the **File Manager option list**, the Send via E-mail form appears:

In this form you can specify a recipient and subject line for an e-mail. When you tap **OK**, an e-mail, with the selected file attached to it, is automatically generated and sent to the outbox of the Pocket Outlook application. The next time you connect to your selected e-mail service, the e-mail is sent to the address you specified.

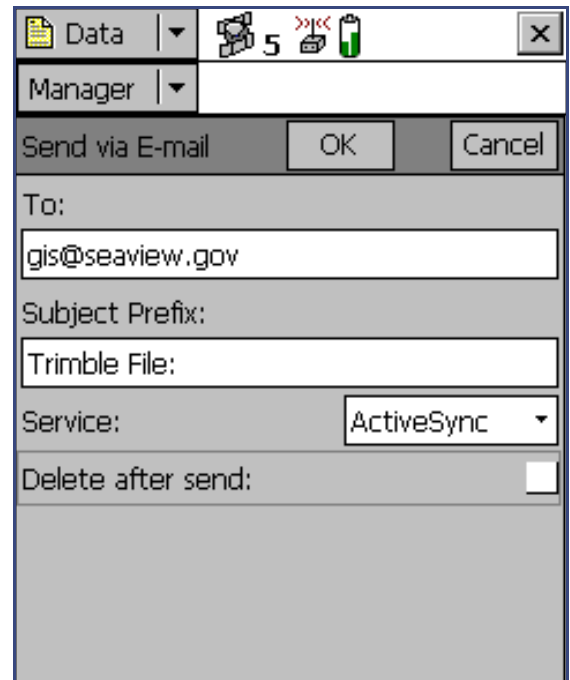

You can use different e-mail services to send data files from the TerraSync software. The default service used is synchronization with your desktop computer. However, you can set up services for connection via a network, cellphone, or modem.

NOTE To successfully send and receive files from within TerraSync, the Inbox service that you use must specify the login details for connecting to your ISP, and must be configured to download the entire message and any attachments, not just the message header.

For more information on adding and configuring services, refer to the Pocket Outlook Help.

NOTE The only file types that the TerraSync software can send by e-mail are data and data dictionary files.

NOTE Trimble is not responsible for setting up your Internet connection, or for solving any Internet problems that may occur. For questions or support concerning your Internet connection, please contact your System Administrator or Internet Service Provider (ISP).

The Send via E-mail form contains the following fields:

- **To**
- **Subject Prefix**
- **Service**
- **Delete after send**



Use this field ...	to ...
To	enter the e-mail address you want to send the selected file to. If you have sent files from the TerraSync software before, this field defaults to the last e-mail address you used.
Subject Prefix	enter a subject line for the e-mail. If you have sent files from the TerraSync software before, this field defaults to the last subject line you used.
Service	specify the e-mail service you want to use to send the message. This field lists all the services that you have defined in Pocket Outlook. By default, the selected service is synchronization with your desktop PC.



Use this field ...	to ...
Delete after send	specify whether to delete the file from the TerraSync document folder when you attach it to an e-mail message. If you select this check box, the data file is moved to the Pocket Outlook outbox. If you clear this check box, a copy of the data file is placed in the outbox, and the original file remains in the document folder. If you have limited space on your field computer, you should select this check box. Only one copy of the file will be stored on your field computer. This file cannot be opened in the TerraSync software. When you next connect to the selected e-mail service and send the e-mail, the data file is deleted.



Receive via E-mail form

Data / File Manager / Options / Receive via E-mail

NOTE This option is only available on field computers that have e-mail support.

When you select the Receive via E-mail option from the **File Manager option list**, the Receive via E-mail form appears:

Use this form to check your e-mail inbox for e-mails with Trimble data files attached to them and transfer the attached files to the TerraSync software.

NOTE You can only use this form to receive files sent by e-mail from:

- the Data Transfer utility (by transferring the files to a GIS E-mail device)
- the GPS Pathfinder Express service

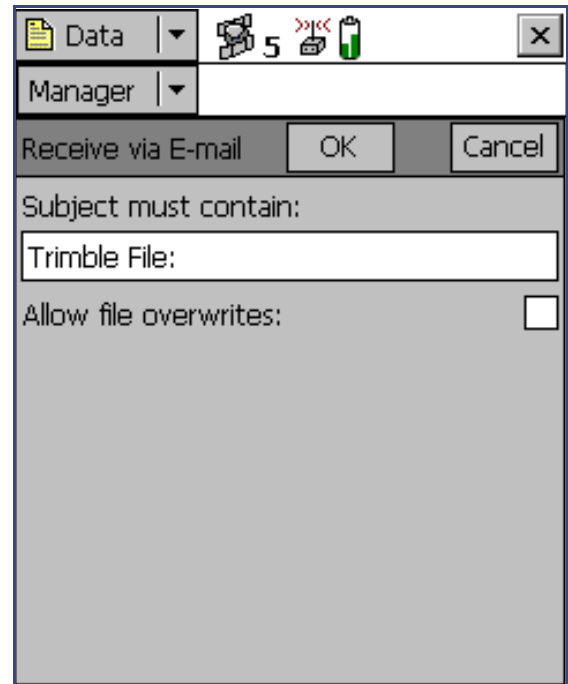

[More...](#)



To receive e-mailed files, enter a subject line in the Subject must contain field, select the Allow file overwrites check box if you want to overwrite existing files with new ones of the same name, and tap **OK**.

The TerraSync software searches the inbox of your e-mail program, selects any e-mails whose subject line includes the text you specified, and transfers any files attached to these e-mails to the TerraSync data folder. The Receive via E-mail form closes.

TIP In the Data Transfer utility in the GPS Pathfinder Office software, you can specify a subject line prefix for each e-mail you send. To transfer all data files successfully into the TerraSync software, make sure the prefix you specify in Data Transfer matches the text you specify in this form.

If you have set up your mail program to leave file attachments on your mail server until requested, the software displays a message asking you to confirm that you want to download each attached file from the server.

NOTE The TerraSync software can only receive the following file types by e-mail:

- data files
- background files
- configuration files
- waypoint files (when sent as data files)
- data dictionary files

[More...](#)



NOTE Trimble is not responsible for setting up your Internet connection, or for solving any Internet problems that may occur. For questions or support concerning your Internet connection, please contact your System Administrator or Internet Service Provider (ISP).

The Receive via E-mail form contains the following fields:

- **Subject must contain**
- **Allow file overwrites**
- **Service**

Use this field ...	to ...
Subject must contain	enter a subject line to search your e-mail inbox for. Only e-mails containing this text in their subject line will be recognized by the TerraSync software as having Trimble data files attached. If you have received files in the TerraSync software before, this field defaults to the last subject line you used.
Allow file overwrites	allow received files to overwrite existing files of the same name.
Service	specify the e-mail service you want to use to receive the message. This field lists all the services that you have defined in Pocket Outlook. By default, the selected service is synchronization with your desktop PC. This field only appears if your CE device is a Pocket PC 2002.



New dictionary form

Data / ... / New dictionary

When you select the New dictionary option from the **File Manager option list**, the New dictionary form appears:

Use this form to specify a name for the new data dictionary. When you have entered a name, tap **OK** to open the **Edit dictionary form**, where you can add features and attributes to the data dictionary.

More...



The New dictionary form contains the following fields:

- **Create dictionary file**

Use this field ...	to ...
Create dictionary file	enter a name for the new data dictionary. A default filename is provided, but you can change or replace this name.



Edit dictionary form

Data / ... / Edit dictionary

When you select the Edit dictionary option from the **File Manager option list**, or tap **OK** in the **New dictionary form**, the Edit dictionary form appears:

NOTE If the data dictionary you are editing is embedded in a data file, the title of this form is Edit embedded dictionary.

Use this form to add features or attributes to the selected data dictionary, or to edit the existing features and attributes.

NOTE Editing a data dictionary file affects all data files that you create subsequently using this data dictionary, but existing data files are not affected. Editing the data dictionary embedded in a data file affects only that data file.



The data dictionary is displayed in a Windows Explorer-style tree. Tap + beside a feature name to expand the feature, showing all its attributes. Tap - beside a feature to collapse the feature, hiding its attributes.

When a feature or attribute is selected, some of its properties are displayed at the bottom of the screen. The properties shown depend on the type of feature or attribute selected.

Use the commands on the **Edit list** to add, edit, move, duplicate, or delete features and attributes. You can also double-tap a feature or attribute to open an editing form where you can view or edit its properties. Tap **Options** to view the **Data Dictionary option list**, which contains commands for editing general properties of the data dictionary.

The Edit dictionary form contains the following:

- **Filename**
- **List of features and attributes**
- **Properties**

Use this field ...	to ...
Filename	check the filename of the open file. This field is read-only.
List of features and attributes	view the features and attributes in the data dictionary.



More...

Use this field ...	to ...
Properties	<p>check the properties of the selected feature or attribute. The information shown depends on the type of feature or attribute selected.</p> <p>If a feature is selected, the following fields appear:</p> <ul style="list-style-type: none"> • Min Positions (for point features), Offset (for line and area features) • Logging Interval • Label 1 • Label 2 <p>If an attribute is selected, the following fields appear:</p> <ul style="list-style-type: none"> • Attribute type, Default, Format • Max length, Min, Max • Generate, Auto-increment • Creation, Update <p>NOTE Only the fields that are relevant to the attribute type appear. For example, the Format field appears only for date and time attributes.</p>



Edit list

 **Data / ... / Edit dictionary / Edit or**

 **Data / ... / New dictionary / Edit**

Tap **Edit** to view the list of available commands for editing the selected data dictionary.

The commands on the Edit list are:

- **Edit Feature**
- **Edit Attribute**
- **New Feature**
- **Undo**
- **Copy**
- **Move Up**
- **Expand All Features**
- **Delete Feature**
- **Delete Attribute**
- **New Attribute**
- **Cut**
- **Paste**
- **Move Down**
- **Contract All Features**

Edit	
Edit Feature	
Delete Feature	
<hr/>	
New Feature	
New Attribute	
<hr/>	
Undo	Ctrl+Z
<hr/>	
Cut	Ctrl+X
Copy	Ctrl+C
Paste	Ctrl+V
<hr/>	
Move Up	Ctrl+U
Move Down	Ctrl+D
<hr/>	
Expand All Features	
Contract All Features	



Use this option ...	to ...
Edit Feature	display the Edit Feature form , where you can view or edit the properties of the selected feature.
Edit Attribute	display the Edit Attribute form , where you can view or edit the properties of the selected attribute.
Delete Feature	delete the selected feature. A message appears, asking you to confirm deletion. Tap Yes to continue.
Delete Attribute	delete the selected attribute. A message appears, asking you to confirm deletion. Tap Yes to continue.
New Feature	open the Edit Feature form , where you can add a new feature to the data dictionary.
New Attribute	open the New Attribute Type form , where you can specify the type of attribute to add to the selected feature.
Undo	undo the last action.
Cut	copy the selected feature or attribute and delete it from the data dictionary. Before you paste the copy, select the feature or attribute that you want to paste it after.
Copy	copy the selected feature or attribute. Before you paste the copy, select the feature or attribute that you want to paste it after.



Use this option ...	to ...
Paste	paste the cut or copied feature or attribute after the feature or attribute that is selected.
Move Up	move the selected feature or attribute one position higher in the list.
Move Down	move the selected feature or attribute one position lower in the list.
Expand All Features	expand all features in the data dictionary, so that all attributes are visible.
Contract All Features	collapse all features in the data dictionary, so that no attributes are visible.



Data Dictionary option list

Data / ... / Edit dictionary / Options

Tap **Options** to view the list of available options for the selected data dictionary.

The options are:

- **Settings for All Features**
- **Auto-generation of Labels**
- **Unique Feature Names**
- **Numeric Defaults Required**



Use this option ...	to ...
Settings for All Features	open the Settings for All Features form .
Auto-generation of Labels	automatically set each feature's labels to the first two attributes.
Unique Feature Names	specify whether duplicate feature names are allowed in the data dictionary. If this option is selected, the Data Dictionary editor checks that all feature names are unique when you save the data dictionary.
Numeric Defaults Required	require that each numeric attribute in the data dictionary has a default value.



Edit Feature form

 **Data / ... / Edit dictionary / Edit / New Feature** or

 **Data / ... / Edit dictionary / Edit / Edit Feature**

When you open a feature for editing, or open a new feature, the Edit Feature form appears. Use this form to specify the feature type (point, line, or area), its default logging settings, and its display settings.

The title of the form is New Feature or Edit Feature, depending on whether you are adding a new feature or editing an existing one.

The Edit Feature form has three tabs:

- **Properties tab**
- **Default Settings tab**
- **Symbol tab** (for point features)
- **Line Style tab** (for line and area features)



Properties tab

Use the Properties tab of the **Edit Feature form** to specify the feature's name and type.

This tab contains the following:

- **Feature**
- **Comment**
- **Feature Classification**

The screenshot shows the 'Edit Feature' dialog box with the 'Properties' tab active. It includes text input fields for 'Feature Name' and 'Comment', and a 'Feature Classification' section with radio buttons for 'Point', 'Line', and 'Area'. The 'Point' option is selected.



Use this field ...	to ...
Feature	specify the name of the feature. You can enter up to 20 characters, including spaces and underscores, but you cannot use punctuation.
Comment	enter an optional description of the feature, or any other comments. You can enter up to 40 characters, including punctuation.
Feature Classification	specify the feature type. The options are: <ul style="list-style-type: none"> • Point A single geographical location, such as a tree or road sign. • Line A connected series of positions, such as a fenceline, road, or river. • Area A polygon or closed line, such as a lake or park.



Default Settings tab

Use the Default Settings tab of the **Edit Feature form** to specify default logging settings. The fields and buttons that appear depend on the feature type (point, line, or area). If the feature is a point feature, this tab contains the following:

- **Default**
- **Logging interval**
- **Minimum Positions**
- **Label 1**
- **Time**
- **Accuracy**
- **Label 2**

If the feature is a line or area feature, this tab contains the following:

- **Default**
- **Logging interval**
- **Distance**
- **Change Format**
- **Time**
- **Accuracy**
- **Direction**

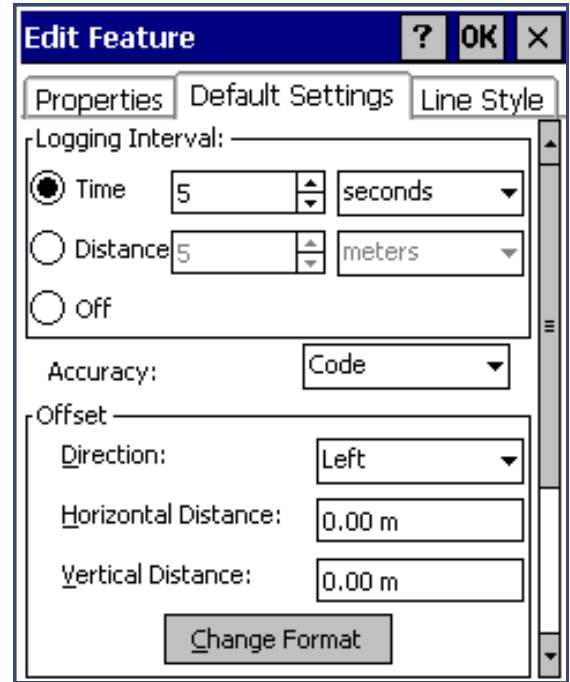

More...



- **Horizontal Distance**
- **Vertical Distance**
- **Slope Distance**
- **Inclination**
- **Label 1**
- **Label 2**

Use this button ...	to ...
Default	reset the general feature properties to their default settings, as defined in the Settings for All Features form .
Change Format	switch between displaying offsets in Horizontal/Vertical format and Distance/Inclination format.

More...



Use this field ...	to ...	Default
Logging interval	specify the default logging style. The options are: <ul style="list-style-type: none"> • Time log a new position when a certain time since logging the last position for this feature has elapsed. • Distance log a new position when you have moved a certain distance from the last position logged for this feature. • Off do not log GPS positions for this feature. 	Time
Time	specify the time between positions and the unit of measure (seconds or minutes), when Time is selected as the logging interval.	5 seconds
Distance	specify the distance between positions and the unit of measure (meters or feet), when Distance is selected as the logging interval. This field only appears if the feature is a line or area.	5 meters

More...



Use this field ...	to ...	Default
Minimum Positions	specify the minimum number of positions to log. This field only appears if the feature is a point.	1
Accuracy	specify whether to log the usual code phase data from the GPS receiver, or to log more detailed but more accurate carrier phase data.	Code
Direction	specify the default direction to the feature, relative to your path of travel. The options are: <ul style="list-style-type: none"> • Left • Right 	Left
Horizontal Distance	specify the default two-dimensional distance to the feature. The horizontal distance ignores any difference in height between your position and the feature. This field only appears if the offset format is Horizontal/Vertical. Use the Change Format button to switch between the display formats	0.00 m

More...



Use this field ...	to ...	Default
Vertical Distance	specify the default vertical distance between your position and the feature. This field only appears if the offset format is Horizontal/Vertical.	0.00 m
Slope Distance	specify the default three-dimensional distance between your position and the feature. This field only appears if the offset format is Distance/Inclination.	0.00 m
Inclination	specify the default angle of inclination between your position and the feature. This field only appears if the offset format is Distance/Inclination.	0.00°
Label 1	select the attribute that will be used as the first label for the feature. Labels appear in the Update Features section and in the position information in The Map section .	First attribute
Label 2	select the attribute that will be used as the second label for the feature.	Second attribute



Symbol tab

Use the Symbol tab of the Edit Feature form to specify the appearance of the symbol used to represent this feature in the Map section and Update Features list. This tab only appears if the selected feature is a point feature.

TIP In **The Map section**, you can choose to display the color you select in this tab, or the color of the map layer that the feature belongs to.

This tab contains the following:

- **Default**
- **Font**
- **Size**
- **Background**
- **Change**
- **Style**
- **Foreground**

More...



Use this button ...	to ...
Default	reset the symbol properties to the defaults. The default point symbol is × (symbol style 33 from the Trimble GPS Pathfinder font, black, 15 points).
Change	select a different font or symbol style.

Use this field ...	to ...	Default
Font	select the font to use for the point feature symbol. You can use any font that is installed on the field computer.	Trimble GPS Pathfinder
Style	select the symbol from the font that you want to use. Symbols are identified by their ASCII character codes, and a preview of the selected symbol is displayed.	33
Size	specify the size that the symbol is displayed at.	15
Foreground	specify the color of the point symbol.	Black
Background	specify the background color of the point symbol. When TerraSync is installed on a CE device, this field is read-only.	Transparent



Line Style tab

Use the Line Style tab of the Edit Feature form to specify the appearance of the line used to represent this feature in the Map section and Update Features list. This tab only appears if the selected feature is a line or area feature.

TIP In **The Map section**, you can choose to display the color you select in this tab, or the color of the map layer that the feature belongs to.

This tab contains the following:

- **Default**
- **Color**
- **Thickness**
- **Join**

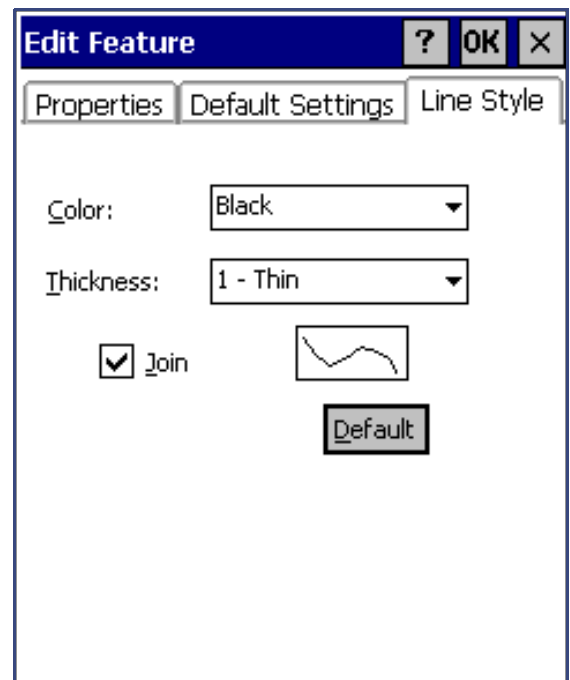

More...



Use this button ...	to ...
Default	reset the line style properties to their default settings (thin black joined line).

Use this field ...	to ...
Color	specify the color of the feature.
Thickness	specify the thickness of the line, or the diameter of the circles if the line is not joined. You can select a width from thin (1 pixel wide) to thick (6 pixels wide). TIP Thicker lines take longer for the software to draw. Use thin lines when you want to maximize the Map screen's drawing speed.
Join	specify whether to display only the positions in the line or area (as circles in the selected color and thickness), or to join all the positions into a line. NOTE In TerraSync, positions are always joined. However, when the line or area feature is viewed in GPS Pathfinder Office, this setting is used to determine its appearance.



New Attribute Type form

Data / ... / Edit dictionary / Edit / New Attribute

Use this form to select the type of attribute that you want to add to the selected feature. Select the attribute type from the list of options, and then tap **Add** to open the **Edit Attribute form**, where you can give the attribute a name and set its properties.

You can select one of the following attribute types:

- **Menu**
- **Numeric**
- **Text**
- **Date**
- **Time**
- **File Name**
- **Separator**

More...



Attribute type	Description
Menu	The value to be stored in the attribute can be selected from a predefined list. For example, the possible values for an attribute called Surface Type for the Road feature may be Asphalt, Concrete, Gravel, and Dirt. The range of possible values is stored in the data dictionary, and in the field you choose the correct value from the list.
Numeric	A set of decimal or whole numbers. For example, these values could represent the girth or height of a tree or the concentration of a pollutant at a particular location.
Text	The value to be stored in the attribute is a string of characters, such as the name of a street.
Date	The value to be stored in the attribute is a date, such as the date of installation of a power pole or the date you collected a feature.
Time	The value to be stored in the attribute is a time value, such as the time you read a meter or the time you collected a feature.

More...



Attribute type	Description
File Name	The value to be stored in the attribute is the name of a file on the field computer. For example, you can use a filename attribute to associate a digital picture of the feature with the feature being collected.
Separator	A separator attribute cannot be edited and does not store a value. It is used to group related attributes or to provide a break in a long list of attributes.



Edit Attribute form

 **Data / ... / Edit dictionary / Edit / New Attribute / Add**

 **Data / ... / Edit dictionary / Edit / Edit Attribute**

When you select Edit Attribute from the **Data Dictionary option list**, or tap **Add** in the **New Attribute Type form**, the Edit Attribute form appears:

Use this form to add a new attribute to the selected feature, or to edit an existing attribute.

The form's title depends on the attribute type, and whether that you are adding or editing the attribute. For example, if you are editing a date attribute, the title is Edit Date Attribute. If you are adding a menu attribute, the title is New Menu Attribute. The fields that appear depend on the attribute type.

More...



The following fields appear for all attribute types:

- **Attribute Name**
- **Comment**
- **On Creation**
- **On Update**

The following fields appear for menu attributes:

- **Menu Attribute Values**
- **New**
- **Edit**
- **Delete**
- **Up arrow**
- **Down arrow**

The following fields appear for numeric attributes:

- **Decimal Places**
- **Minimum**
- **Maximum**
- **Auto-Incrementing**
- **Step Value**

The following fields appear for text attributes:

- **Length**
- **Default**
- **Auto-Incrementing**
- **Step Value**

More...



The following fields appear for date and time attributes:

- **Auto Generate on Creation**
- **Auto Generate on Update**
- **Format**

Use this button ...	to ...
New	open the Edit Attribute Value form to add new attribute values.
Edit	open the Edit Attribute Value form to edit the selected attribute value.
Delete	delete the selected attribute value.
Up arrow	move the selected attribute value to the previous position in the list.
Down arrow	move the selected attribute value to the next position in the list.

Use this field ...	to ...	Default
Attribute Name	specify the name of the attribute. You can enter up to 20 characters, including spaces and underscores, but you cannot use punctuation.	(none)

[More...](#)



Use this field ...	to ...	Default
Comment	enter an optional description of the attribute, or any other comments. You can enter up to 40 characters, including punctuation.	(none)
On Creation	set editing rules for the attribute when a new feature is opened. The options are: <ul style="list-style-type: none"> • Normal Entering a value for this attribute is optional. • Required A value must be entered for this attribute. • Not Permitted The value of this attribute cannot be changed. 	Normal
On Update	set editing rules for the attribute when the feature is opened for update. The options are as for the On Creation field.	Normal
Menu Attribute Values	view the list of values for a menu attribute. Use the New and Edit buttons to add or edit values in this list.	(none)

[More...](#)



Use this field ...	to ...	Default
Decimal Places	set the number of decimal places for a numeric attribute.	0
Minimum	set a minimum value for a numeric attribute.	0
Maximum	set a maximum value for a numeric attribute.	0
Length	specify the maximum length for a text attribute. The length can be any integer from 1 to 100.	30
Default	specify a default value for the attribute.	(none)
Auto-Incrementing	specify whether the default value for the attribute is supplied by automatically incrementing or decrementing the value of the last attribute of this type that was entered. The options are: <ul style="list-style-type: none"> • No Increment No auto-incremented default value is supplied. • Increment An auto-incremented default value is supplied. 	No Increment
Step Value	specify the amount by which the attribute value increments or decrements.	+1

More...



Use this field ...	to ...	Default
Auto Generate on Creation	specify whether the attribute is automatically filled in with the current date or time when the feature is created.	Selected
Auto Generate on Update	specify whether the attribute is automatically filled in with the current date or time when the feature is opened for update.	Not selected
Format	specify the display format of the attribute. If the attribute type is Date, the options are: <ul style="list-style-type: none"> • Day - Month - Year • Month - Day - Year • Year - Month - Day If the attribute type is Time, the options are: <ul style="list-style-type: none"> • 24 Hour • 12 Hour 	Year - Month - Day (for Date attributes) or 24 Hour (for Time attributes)



Edit Attribute Value form

 **Data / ... / Edit dictionary / Edit / New Attribute / Add / New**

 **Data / ... / Edit dictionary / Edit / Edit Attribute / Edit**

When you tap New or Edit in the **Edit Attribute form**, the Edit Attribute Value form appears:

Use this form to add new attribute values, or edit existing values, for the selected menu attribute.

The title of the form is New Attribute Value or Edit Attribute Value, depending on whether you are adding a new attribute value or editing an existing one.

The Edit Attribute Value form contains the following:

- **Attribute Value**
- **Default**
- **Code Value 1**
- **Code Value 2**
- **Add/OK**
- **Cancel/Close**

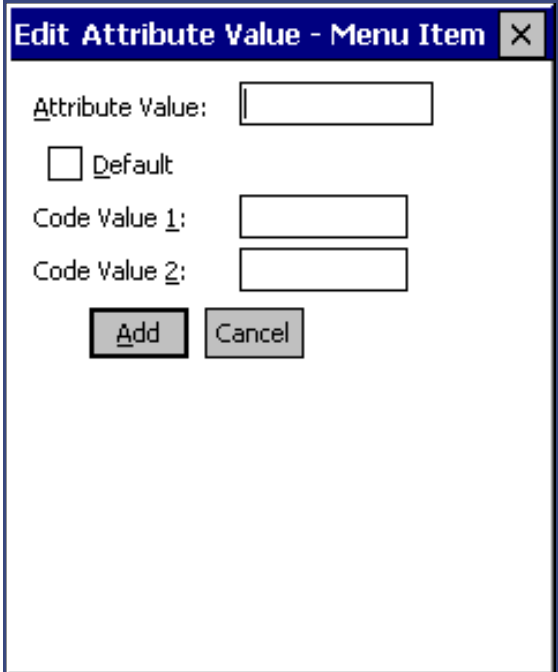

More...



Use this field ...	to ...
Attribute Value	specify the value of the attribute. The value can be up to 20 characters long.
Default	specify whether this value is the default value in the list.
Code Value 1	define a code value for this attribute value. Use code values if you want to see a list of descriptive attribute values in the field, but you need to export a code to your GIS or CAD system. Code values are optional, and can be up to 6 characters long.
Code Value 2	define a second code value for this attribute value.

More...



Use this button ...	to ...
Add/OK	<p>add the new value to the list, or confirm the changes you have made to the existing value.</p> <p>If you opened this form by tapping Add in the Edit Attribute form, this button is labeled Add. After you tap it, the form remains open so that you can add a number of values to the list without reopening this form each time.</p> <p>If you opened this form by tapping Edit in the Edit Attribute form, this button is labeled OK. After you tap it, the form closes.</p>
Cancel/Close	<p>close this form.</p> <p>If you have made changes in this form but have not yet tapped Add or OK, this button is labeled Cancel. If you use it to close the form, a message appears asking you to confirm that you want to close the form without saving your changes. Tap Yes to continue.</p> <p>If you have saved your changes by tapping Add, this button is labeled Close.</p>



Settings for All Features form

Data / ... / Edit dictionary / Options / Settings for All Features

Use this form to specify default logging settings for all features in the data dictionary. When you create a new feature, or tap **Default** in the Edit Feature form's **Default Settings tab**, the feature's logging settings are set to the values you define in this form.

The fields in the Point tab are the same as the fields in the **Default Settings tab** of the Edit Feature form when the selected feature is a point.

The fields in the Line and Area tabs are the same as those in the **Default Settings tab** when the selected feature is a line or area.

WARNING When you make changes in this form, any feature defaults that you have customized in the data dictionary are replaced with the new values defined here.



Read dictionary from data form

Data / File Manager / Options / Read dictionary from data

When you select the Read dictionary from data option from the **File Manager option list**, the Read dictionary from data form appears:

Use this form to extract the data dictionary from a TerraSync data file. Before you open the form, first make sure that the data file selected in the File Manager screen is the one that you want to extract the dictionary from.

In the Read dictionary from data form, specify an output filename in the Create dictionary file field. To create the file, tap **OK**. When the file has been created, the form closes and you are returned to the **File Manager** form. The new file appears in the **List of files** when Dictionaries is selected in the **Choose File** field.



More...



The Read dictionary from data form contains the following fields:

- **Create dictionary file**
- **Data File**

Use this field ...	to ...
Create dictionary file	specify a name for the new data dictionary file. The TerraSync software uses the name of the data file as the default filename for the new data dictionary. You can edit this default name, or enter an entirely different name. Filenames must follow the naming rules for Windows.
Data File	check that the correct data file is selected. This field is read-only. To change the selected data file, tap Cancel and select a different file in the File Manager screen.



Read from Shape form

Data / File Manager / Options / Read data from Shape

When you select the Read data from Shape option from the **File Manager option list**, the Read from Shape form appears:

Use this form to convert ArcView Shapefiles on your field computer into data, data dictionary, or **vector** background files suitable for use in the TerraSync software. You can select which input files to use, and the name of the output file, but you cannot change any other conversion settings.

Before you open the Read from Shape form, first make sure that the file type selected in the Choose File field in the File Manager screen is the file type that you want to create. For example, if you want to create a data dictionary from Shapefiles, select Dictionaries from the Choose File field, then tap **Options** and select Read data from Shape.

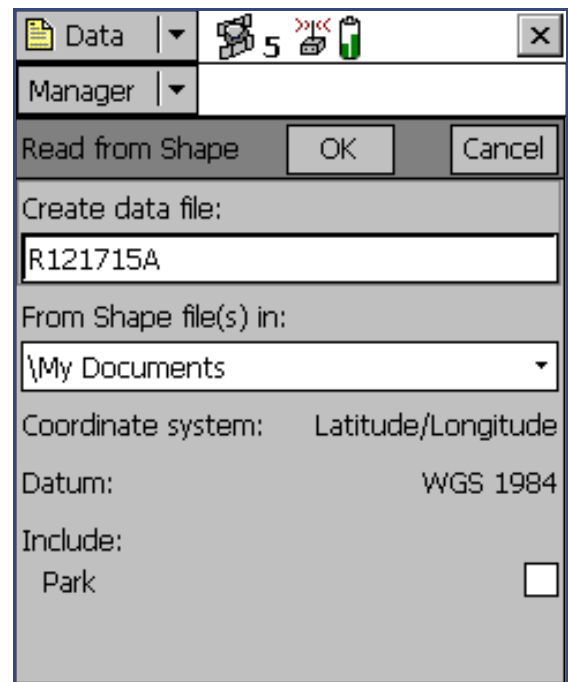

Data	5	>><<	🔋	✕
Manager				
Read from Shape	OK	Cancel		
Create data file:	R121715A			
From Shape file(s) in:	\\My Documents			
Coordinate system:	Latitude/Longitude			
Datum:	WGS 1984			
Include:	Park <input type="checkbox"/>			



Also make sure that the coordinate system that you want the output file to use is selected in the Setup section. For more information, see **Coordinate System**.

In the Read from Shape form, specify an output filename in the Create <file type> file field, and check that the coordinate system shown is correct. Then select the folder on your field computer that contains the Shapefiles you want to convert. To select the folder, enter its full path and name in the From Shape file(s) in field. Alternatively, tap the drop-down arrow and in the pop-up window that appears navigate to the folder you want.

Once you have selected an input folder, the separator field Include and a check box for each Shapefile in the folder appear in the form. To include a Shapefile in the conversion, select its check box. To exclude a file, clear its check box.



To begin the conversion, tap **OK**. The fields in the form are replaced by a progress bar and summary information about the conversion.

When the files have been converted, the message **Shape conversion complete** replaces the progress bar, and also appears in a ToolTip in the status bar:

Tap **Close** to return to the **File Manager** form. The new file appears in the **List of files**.

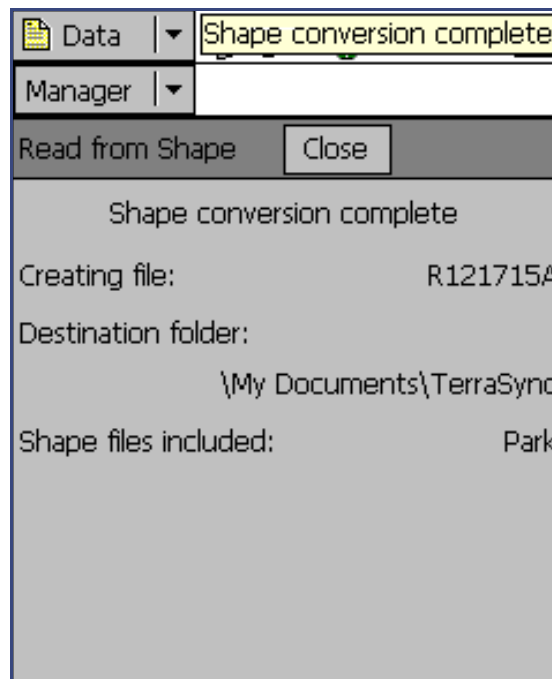

The Read from Shape form contains the following fields:

- **Create <file type> file**
- **In coordinate system**
- **From Shape file(s) in**
- **Include**



Use this field ...	to ...
Create <file type> file	specify a name for the new file. The TerraSync software automatically generates a default filename for the new data, data dictionary, or background file, using the same naming convention as in the File Name field in the New File section. You can edit this default name, or enter an entirely different name. Filenames must follow the naming rules for Windows, but you should not specify an extension.
From Shape file(s) in	select the folder where the source Shapefiles are stored.



Use this field ...	to ...
In coordinate system	check that the coordinate system that the new file will use is correct. This field shows the current coordinate system. NOTE When you create a data or background file, the current coordinate system must match the coordinate system in the input Shapefiles. Use the Setup section's Coordinate System form to change the coordinate system if necessary. NOTE When you create a data dictionary file, the coordinate system does not matter.
Include	specify which Shapefiles in the selected folder to include in the converted file. Select the check box beside each Shapefile name to include features in this Shapefile in the converted file.



Write to Shape form

Data / File Manager / Options / Write data to Shape

When you select the Write data to Shape option from the **File Manager option list**, the Write to Shape form appears:

Use this form to convert a data file from the TerraSync software into ArcView Shapefiles. You can select the location of the output files, but you cannot change any other conversion settings. The conversion creates a separate Shapefile for each feature type in the input data file.

The input data file in the **Convert file** field is the file that was highlighted in the list of files in the **File Manager** screen. To change the selected file, return to the File Manager screen and select a different file.

[More...](#)



To convert a data file to Shapefiles, select the folder on your field computer where you want to create the Shapefiles. To select the folder, enter its full path and name in the Write Shape file(s) to field. Alternatively, tap the drop-down arrow and in the pop-up window that appears navigate to the folder you want.

To begin the conversion, tap **OK**. The fields in the form are replaced by a progress bar and summary information about the conversion:

When the file has been converted, the message **Shape conversion complete** replaces the progress bar. Tap **Close** to return to the **File Manager** form.

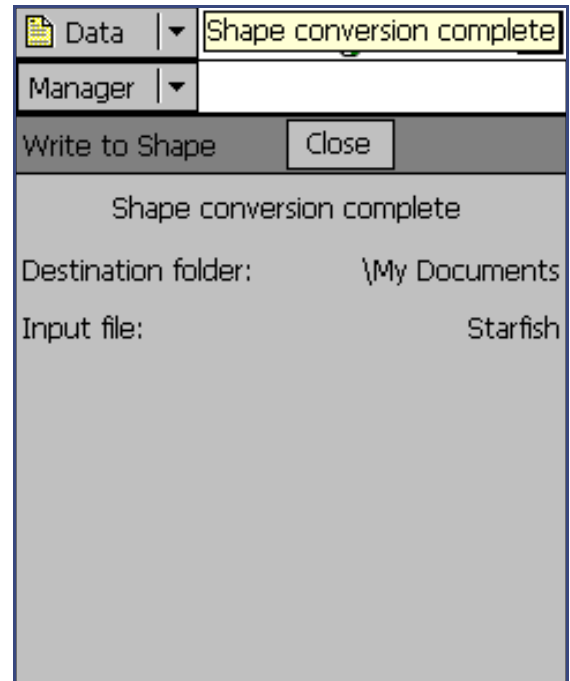

The Write to Shape form contains the following fields:

- **Convert file**
- **Write Shape file(s) to**
- **Coordinate system**
- **Zone**
- **Datum**

More...



Use this field ...	to ...
Convert file	check that you have selected the correct input data file. If this field does not show the correct filename, return to the File Manager screen, highlight the correct file in the list, and select the Write data to Shape option again.
Write Shape file(s) to	specify the folder where the Shapefile(s) will be stored.
Coordinate system	check that the coordinate system that the new data file will use is correct. This field shows the current coordinate system. Use the Setup section's Coordinate System form to change the coordinate system if necessary.
Zone	check that the coordinate system that the new data file will use is correct. This field does not appear if the selected coordinate system does not have zones.
Datum	check that the datum that the selected coordinate system and zone are associated with is correct. If the system can be associated with only one datum, this field does not appear.



The Navigation section

Use the Navigation section to:

- make sure that you follow a direct course to a target location
- revisit features you have previously mapped

Even if you do not want to navigate to a particular point, you can use the Navigation section to view information such as your current heading or the distance to the target.

There are two navigation modes, depending on how close you are to the navigation target. Use the **Direction Dial** screen to navigate to the target from a distance, and the **Close-up screen** to navigate to the exact location of the target.

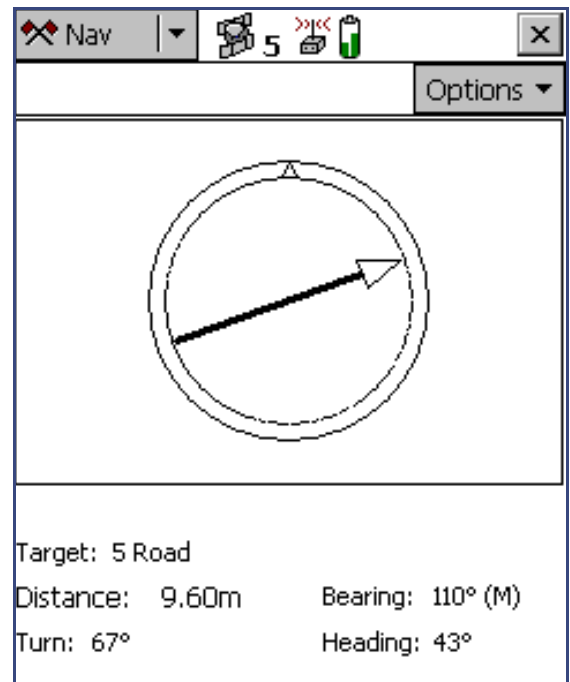

NOTE With **real-time differential GPS**, you can navigate to an accuracy of one meter or less (depending on factors such as your GPS receiver and the frequency at which corrections are received). Without any form of real-time differential corrections, you are subject to errors introduced by GPS and atmospheric conditions, which degrade the accuracy of your navigation. Autonomous navigation (without real-time corrections) can still be useful to get you close to the feature, but it may be less useful for locating a specific feature if similar features are near to each other, or the feature is underground.



Direction Dial

Navigation

When you first open the Navigation section the default screen displayed is the Direction Dial graphical screen.

The Direction Dial graphical screen provides a simple dial which shows you all the information you need to get to the target. It is very useful for navigation in open country or where you can follow a direct route to the target.

- **Using the Direction Dial**

TIP You cannot set the navigation target in the Navigation section.

Select a target from **The Data section** or **The Map section**.

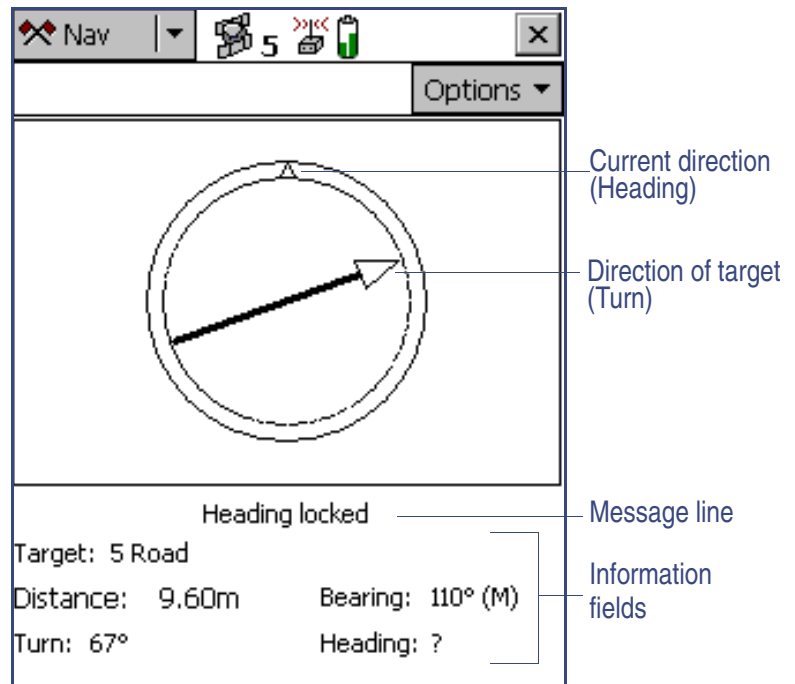

More...



The Direction Dial graphical screen contains:

- **Heading**
- **Turn arrow**
- **Message line**
- **Information fields**

Item	Description
Heading	The top of the dial indicates your direction of travel (heading).
Turn arrow	The turn arrow shows the direction you should travel in order to take the shortest path between the current GPS position and the target.
Message line	The Message line displays messages relating to navigation.
Information fields	The Information fields at the bottom of the screen provide navigational information.



Using the Direction Dial

The heading along which you are moving (your current direction of travel) is always shown at the top of the dial. The Turn arrow shows where the target is, relative to your heading. To navigate to the target, simply line up the arrow (the direction of the target) with the triangle at the top of the dial (your current direction of travel).

The arrow on the dial rotates according to your direction of travel. Consequently, the dial only provides an accurate reading when you are moving, and a direction of travel can be determined by the receiver. If you are moving too slowly, or are standing still, the Heading arrow freezes. For more information, see [Message line](#).

TIP Because the Direction Dial screen is based on your heading, it works best if you do not move backwards.

NOTE Until GPS is acquired and a target is specified, the heading cannot be calculated so the turn arrow does not appear.

To activate navigation, select a target. When you select a target, the Direction Dial displays information to assist you in navigating to it. The Direction Dial graphically displays your heading and the bearing to the target. The Information fields at the bottom of the screen display relevant text information. The message line also shows relevant information for navigation.



[More...](#)

TIP You cannot set the navigation target in the Navigation section. Select a target from [The Data section](#) or [The Map section](#).

NOTE If you log a new GPS position for the feature that is currently selected as the navigation target, you must reselect it as the navigation target before you can navigate to the new location.



Close-up screen

Navigation

When you are in the **Direction Dial** graphical screen and within the specified **Close-up Range** to the target, the navigation proximity alarm sounds, and the Close-up graphical screen replaces the Direction Dial screen.

- **Using the Close-up screen**

The Close-up graphical screen contains:

- **Bull's-eye**
- **Cross**
- **Message line**
- **Information fields**

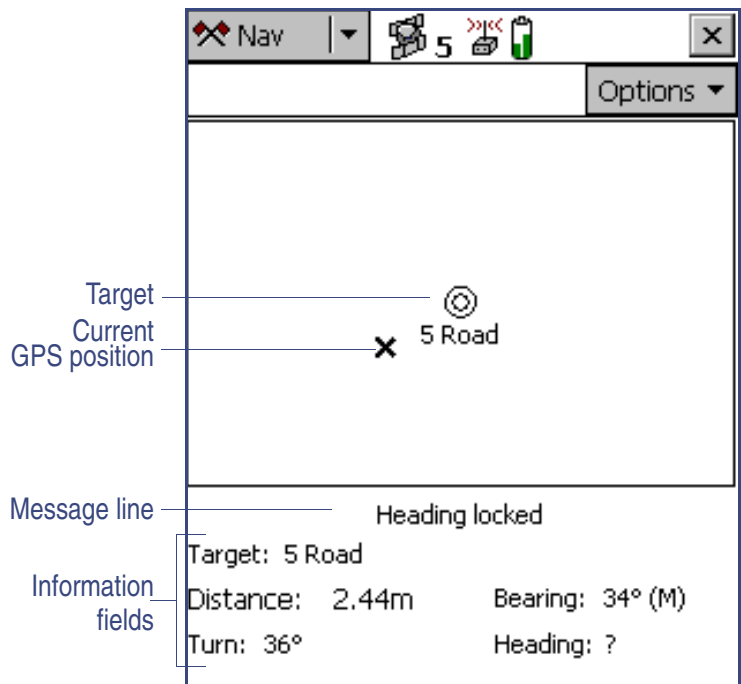

Item	Description
Bull's-eye	The bull's-eye represents the navigation target.
Cross	The cross represents the current GPS position.
Message line	The Message line displays messages relating to navigation.
Information fields	The Information fields at the bottom of the screen provide navigational information.



Using the Close-up screen

For precision navigation right up to the target, move so that the GPS position cross is in the center of the bull's-eye. Depending on the **Close-up Style** you select, either the bull's-eye or the cross remains fixed in the center of the screen, while the other moves around it.

The top of the Close-up screen is relative to the direction of travel (heading) when you entered the Close-up screen. The heading is not updated on the Close-up screen, so the screen does not move if you change the direction you are facing while using it.

All **Information fields** that depend on the heading are automatically locked as well. For more information, see **Heading locked**.

- TIP** Because the Close-up screen does not update your heading, it works best if you maintain your original direction of travel and if necessary move sideways or backwards rather than turn.
- TIP** To quickly open the feature that is set as the target for update, double-click the bull's-eye in the Close-up screen.

- **Close-up Range**
- **Close-up Style**



Close-up Range

The close-up range value controls the distance from the target at which the Direction Dial graphical screen switches to the Close-up graphical screen. You can configure the close-up range value either to control the distance at which the Close-up screen appears, or to disable it.

The close-up range also determines the scale that is represented on the Close-up screen. The distance from the edge of the screen to the center represents the close-up range distance.

- TIP** If you are zoomed in to a scale that is too close for the GPS accuracy you currently have, the GPS cross appears to leap around the screen. To minimize this effect, select a larger close-up range.

You can configure the close-up range values from the **Navigation options form**.



Close-up Style

The close-up style can be set to either **Target-centered** or **GPS-centered**. It controls which position is the fixed reference point in the center of the Close-up screen: your position or the position of the target. For the target-centered style, the target bull's-eye is fixed in the center of the screen and the GPS cross moves around it as your position changes. For GPS-centered navigation the opposite occurs; the GPS cross is fixed in the center of the screen and the bull's-eye effectively moves around it.

You can configure the close-up style from the **Navigation options form**.



Information fields

Additional information about the selected navigation target appears in information fields. These fields appear below the **Direction Dial** graphical screen or the **Close-up screen**.

NOTE If your field computer uses the landscape orientation, the information fields appear to the right of the Navigation screen.

The Navigation section contains the following information fields:

- **Target**
- **Distance**
- **Bearing**
- **Turn**
- **Heading**

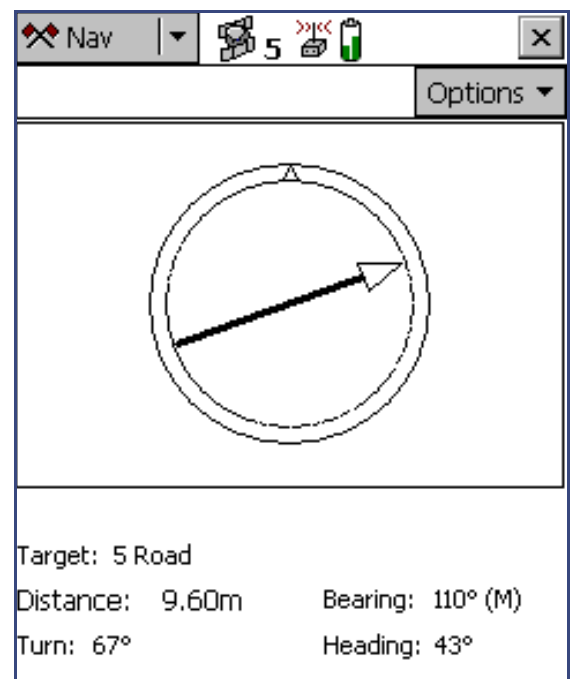

Field	Description
Target	The feature ID and feature type of the current navigation target. Alternatively, if you have selected a map point as the target, this field shows the text Map Point .
Distance	The distance to the navigation target. This is the shortest great-circle distance to the target, computed on your local datum . TIP You can use the Units form in the Setup section to change the units that the distance is displayed in.
Bearing	The compass bearing (angle) which you should follow in order to take the shortest path between the current GPS position and the target. The bearing is useful if you are navigating in open country and can travel in a direct line to the target. The bearing is displayed with a T if it is relative to true north or an M if it is relative to magnetic north .
Turn	The direction you need to turn to head towards the target. It indicates the magnitude by which your course should vary (the difference between the bearing to the target and the current heading).

More...



Field	Description
Heading	Your current direction of travel. The heading is the angle between the last two GPS positions computed. If you are stationary or moving very slowly, the heading is locked until you start moving again. The units of this field also include a T or M to indicate whether the heading is relative to true north or magnetic north . The heading is displayed whether or not you have chosen a target.

NOTE If no target has been selected, the Target field shows the text **No Target** and the Distance, Turn, and Bearing fields show the text **n/a**. If you are stationary or are not moving fast enough for the software to calculate a heading, all fields except Target show the text **?**, and the **Message line** prompts you to start moving.



Message line

The message line appears above the **Information fields**. It displays important messages relevant to navigation. The following messages may appear:

Message	Meaning
Heading locked	You are stationary or moving too slowly for an accurate heading to be computed. This message flashes alternately with the message start moving . The direction dial arrow and any Information fields affected freeze. To unlock the heading, start moving faster than the cutoff velocity . NOTE The cutoff velocity is 0.35 meters/second (1.26 kilometers/hour, or 0.78 miles/hour). NOTE The heading is always locked when the Close-up screen is visible.
Heading not available	No heading can be calculated because you have not started moving (fast enough) since the GPS receiver was connected. This message alternates with the message start moving until you begin to move.

More...



Message	Meaning
No GPS	The TerraSync software is not connected to a GPS receiver.
Old navigation	GPS position information is temporarily unavailable (for example, because one or more satellites is obscured, or satellite geometry is poor). The TerraSync software still displays the most recent navigation information. The direction dial arrow and any Information fields affected also flash.
Set your navigation target in the Map or Data section	You have not selected a navigation target. Select a target in The Map section or The Data section .
Start moving	Your speed is not sufficient for an accurate heading to be calculated: you are either stationary or are not moving fast enough. This message alternates with Heading not available , if you have not moved since connecting to GPS, or Heading locked , if you have slowed down too much since the last heading was calculated.



Navigation options form

Navigation / Options / Navigation Options

To display the Navigation options form, tap **Options** in the Direction Dial screen or the Close-up screen, and select Navigation Options.

Use this form to specify settings for the Navigation section.

These fields are available in the Navigation options form:

- **Close up Range**
- **Close up Style**

More...



Use this field ...	to ...	Default value
Close up Range	specify the distance from the target to activate the Close-up screen. Select None to stop the Close-up screen from ever appearing, or enter a value to activate the Close-up screen at that distance.	5.00 m
Close up Style	specify the style for the Close-up screen. The options are: <ul style="list-style-type: none"> • Target-centered the target remains still in the center of the screen and your GPS position is displayed relative to it. • GPS-centered your GPS position remains still in the center of the screen and the target is displayed relative to it. 	Target-centered



The Status section

To open the Status section, tap the Section list button and select Status.

Use this section to view information about external connections, including the GPS receiver and any real-time differential correction source.

The Status section has nine subsections:

- **Skyplot**
- **Plan**
- **Real-time**
- **Comms**
- **About**
- **Satellite information**
- **Receiver**
- **Sensor**
- **UTC Time**

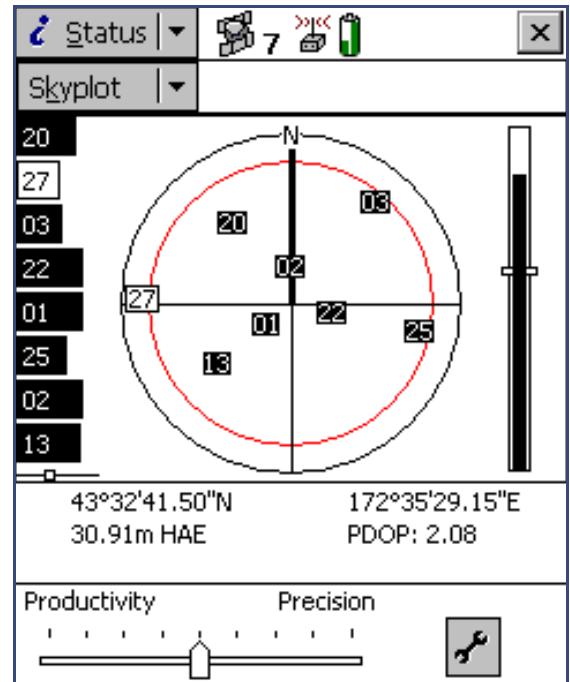

Skyplot

Status / Skyplot

The Skyplot graphical screen is the default screen displayed when you open the Status section. It provides a graphical display of the satellites available to the receiver:

To display the Skyplot when another screen in the Status section is visible, tap the Subsection list button and select Skyplot.

The Skyplot screen includes a **Skyplot**, **SNR graph**, and **Satellite geometry indicator**. **Information fields**, a **Message line**, and a **Setup area** also appear at the bottom of the screen.

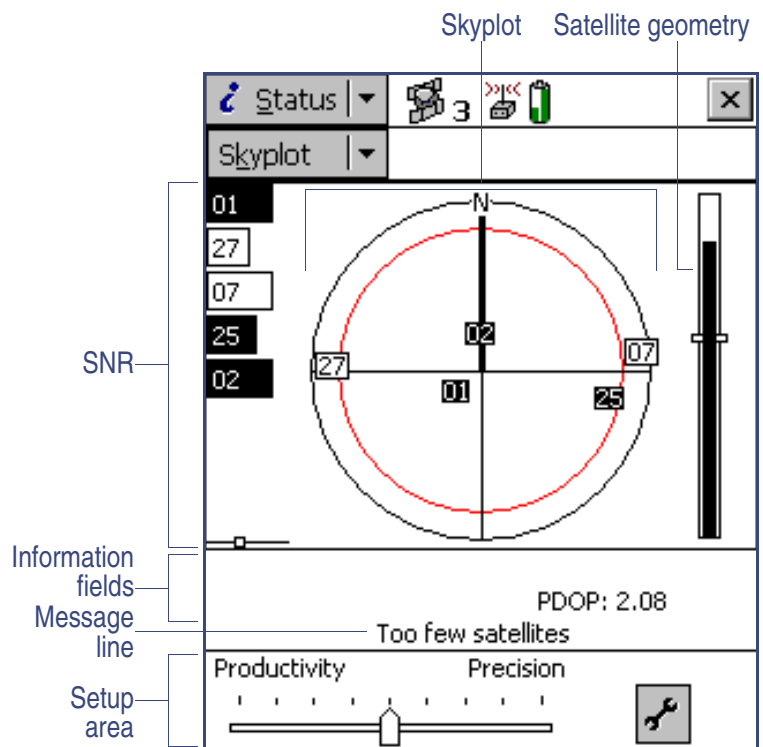

Skyplot

The black outer circle represents the **horizon** (at 0°). The inner circle, which appears in red on a color screen, represents the configured **Min Elevation**. When the minimum elevation value is changed, the inner circle of the skyplot changes diameter accordingly.

If the minimum elevation is increased, the inner circle gets smaller and only those satellites higher in the sky are used to compute GPS positions. If the minimum elevation is decreased, the inner circle gets larger and satellites closer to the horizon are used to compute GPS positions.

Numbered boxes represent the satellites currently available to the TerraSync software. The satellites near the center of the circle are higher in the sky (overhead), while those toward the edge are closer to the horizon. The location of any one satellite can be determined by noting its direction (N, S, E, W) and approximate elevation in the skyplot.

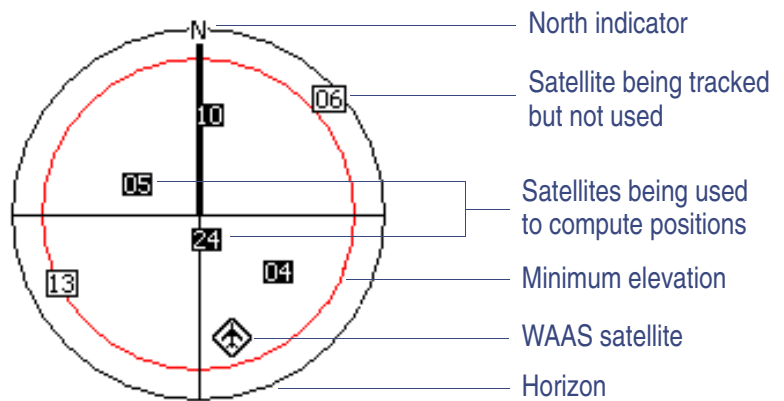

Satellites shown as filled black boxes are currently being used by the TerraSync software to compute GPS positions. Satellites with white boxes are being tracked, but are not being used to compute positions. Satellites with no boxes are available, but are not being tracked. The location of the **WAAS** satellite being tracked is indicated by this icon:

When you tap the skyplot, a ToolTip appears, showing details about the area you have tapped. For more information, see **ToolTips**.

The skyplot rotates (like a compass) to indicate the direction you are travelling in. Your direction is calculated from the last GPS positions received. If no positions have been received recently, the direction shown may not be correct.

NOTE The skyplot only rotates if you are moving.

When you turn the receiver on, it begins to track visible satellites and to calculate the current position. Once the first position is displayed, subsequent positions are updated once per second.

TIP If no positions are computed, look for obstructions that might be blocking satellite signals. Move away from any possible obstructions. If the receiver is still not computing positions, see **Troubleshooting**.



SNR graph

The SNR bar graph on the left of the **Skyplot** screen is a graphical representation of the signal quality of each satellite that the GPS receiver is currently tracking. A black bar represents a satellite with a signal strength above the configured minimum level. An empty bar represents a satellite that is not being used to compute GPS positions because its signal strength is below the configured minimum level.

The white box in the indicator at the bottom of the graph shows the configured minimum SNR value.

When you tap the SNR graph, a ToolTip appears, showing details about the area you have tapped. For more information, see **ToolTips**.

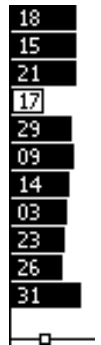

Satellite geometry indicator

The satellite geometry indicator on the right of the **Skyplot** screen is a graphical representation of the overall quality of the GPS positions computed. The white horizontal bar shows the configured minimum quality value, and the level of black inside the indicator shows the current quality value.

When you tap the satellite geometry indicator, a ToolTip appears, showing details about the area you have tapped. For more information, see **ToolTips**.

The quality of the computed positions is a function of the geometry of the visible satellites (how they are positioned in the sky relative to each other and you). When the satellites are well spaced, and cover a large portion of the sky, the GPS receiver can compute accurate positions and the level inside the indicator is high. If satellites are grouped together in the sky, the precision of the computed positions is reduced, and the level inside the indicator is low.



ToolTips

When you tap any of the elements in the Skyplot screen, a ToolTip appears. The ToolTip provides detailed information about the element that you have tapped.

When you tap this ...	the ToolTip shows this information ...
Bar on SNR graph	Satellite PRN and SNR value
White box on indicator below SNR graph	Configured minimum SNR value
Geometry indicator	Current PDOP or HDOP value
Horizontal bar on geometry indicator	Configured maximum PDOP or HDOP value
Satellite on skyplot	Satellite PRN, SNR value, elevation and bearing
Inner circle on skyplot	Configured minimum elevation value



Information fields



The following information fields appear below the Skyplot graphical screen:

- **GPS position**
- **PDOP**
- **HDOP**

NOTE If your field computer's screen uses the landscape orientation, the information fields appear to the right of the Skyplot.

Display	Description
GPS position	<p>The current GPS position is displayed in terms of the currently configured coordinate system and datum. To change this configuration, use the Coordinate System form in the Setup section.</p> <p>NOTE Positions viewed on the screen are not saved. To save them, open a data file and start a feature.</p>



Display	Description
PDOP	The Position Dilution of Precision (PDOP) is a numeric value representing the satellite geometry. If you set a Max PDOP value, and the PDOP rises above the value you set, the TerraSync software stops computing positions. To set the maximum PDOP value, use the GPS slider in the Setup area , or tap the Setup button  to open the GPS Settings form from the Setup section.
HDOP	This field only appears if you have configured a maximum PDOP. The Horizontal Dilution of Precision (HDOP) represents the vertical component of the PDOP. If you set a Max HDOP value, and the HDOP rises above the value you set, the TerraSync software stops computing positions. To set the maximum HDOP value, tap the Setup button  to open the GPS Settings form from the Setup section. This field only appears if you have configured a maximum HDOP.



Message line

The message line below the **Skyplot** graphical screen and the **Satellite information** table displays any error or warning messages. Messages only appear when there is a problem or a condition you should be aware of. For example, if the satellite geometry is good, no message appears, but when it is poor, a message appears.

The following messages may appear:

Message	Meaning
GPS disconnected	The GPS receiver is not connected.
Attempting to connect to GPS receiver	The TerraSync software is trying to establish a connection with the GPS receiver. This message appears when you start the TerraSync software and whenever you try to reconnect to GPS.
Antenna is not connected to GPS receiver	The GPS receiver cannot detect the antenna, or the antenna cable is not connected to the GPS receiver.
Heading locked	The GPS receiver is stationary or moving too slowly to calculate an accurate heading. When the heading is locked, the skyplot does not rotate.

More...



Message	Meaning
Old position	The receiver has stopped computing positions, so the GPS position displayed in the Information fields is not the current position. This message alternates with either the Poor satellite geometry message or the Too few satellites message.
Poor satellite geometry	The PDOP or HDOP is higher than the level you specified in the GPS Settings form of the Setup section. NOTE When the geometry of the satellites is poor, the satellite icon in the Status bar flashes. This icon is always visible, regardless of which section you are in.
Too few satellites	The GPS receiver is not tracking enough satellites to compute a GPS position. NOTE When there are too few satellites to compute GPS positions, the number below the satellite icon in the Status bar flashes. This icon is always visible, regardless of which section you are in.



Setup area

The Setup area at the bottom of the **Skyplot** and the **Satellite information** screens shows the current GPS settings. The Setup area has two modes: Slider and Custom.

In **Slider** mode, the Setup area displays a slider bar. The position of the slider bar indicates the current GPS settings. The GPS slider makes it easy for you to choose between productivity and precision, without needing to know the best values for each setting.

TIP The default position (in the middle of the slider bar) is the most productive setting at which the precision specifications of the GPS receiver are met.

To change GPS settings in Slider mode, move the slider bar to the left or right. The slider duplicates the GPS slider in the Setup section's **GPS Settings** form, so any changes you make to the slider position in the Setup area are also made in the GPS Settings form.

In **Custom** mode, the Setup area shows the configured limits for PDOP or HDOP, elevation, and SNR. To change to Custom mode, tap the Setup button  to open the **GPS Settings** form, then clear the Slider check box.



Satellite information

Message line

Status / Satellite Information

To display the Satellite information table, tap the Subsection list button and select Satellite Info.

Use this screen to view information about satellites in text form.

The Satellite information table displays the following information:

- Use indicator
- PRN
- SNR
- Elev
- Br(T) or Br(M)

As in the Skyplot screen, **Information fields**, a **Message line**, and a **Setup area** appear at the bottom of the screen.

	PRN	SNR	Elev	Br (T)
●	04	16.1	40°	125°
●	05	16.1	56°	297°
○	06	6.18	14°	243°
●	10	16.5	42°	8°
○	13	5.97	9°	118°
●	24	20.3	75°	159°
●	30	12.1	42°	243°

Almanac: 06/14/02 PDOP: 2.08

Productivity Precision



Column	Description
Use indicator	This column displays a filled circle (●) for a satellite that is being used to calculate positions, and an outlined circle (○) for any satellite that is visible but is not being used to calculate positions, for example because it is below the configured minimum elevation. Satellites with no circle are available, but are not being tracked by the TerraSync software.
PRN	The pseudorandom number of each satellite. A satellite is identified uniquely by its PRN.
SNR	The current signal-to-noise ratio of each satellite. A satellite that is below the configured Min SNR is not used to compute positions. NOTE If a satellite is marked as “unhealthy” by the GPS Control Segment, the characters U/H appear in the SNR column for that satellite.
Elev	The current elevation above the horizon of each satellite. A satellite that is below the configured Min Elevation is not used to compute positions.
Br(T) or Br(M)	The current bearing to each satellite. This bearing is shown relative to either true north (T) or magnetic north (M), as determined by the currently configured North Reference .



Information fields

The following information fields appear below the Satellite information table:

- Almanac
- PDOP
- HDOP

NOTE If your field computer's screen uses the landscape orientation, the information fields appear to the right of the Satellite information table.

Display	Description
Almanac	The date of the last almanac received from satellite broadcasts.
PDOP	The current PDOP value. This field only appears if you have configured a maximum PDOP.
HDOP	The current HDOP value. This field only appears if you have configured a maximum HDOP.



Plan

Status / Plan

To display the Plan screen, tap the Subsection list button and select Plan.

The Plan screen lets you plan your data collection session while you are in the field. You can view an animated skyplot and DOP graph for your current position over the next 12 hours, and use these to plan data collection around the times of the day when satellite geometry is best. For more information, see **Planning a data collection session**.

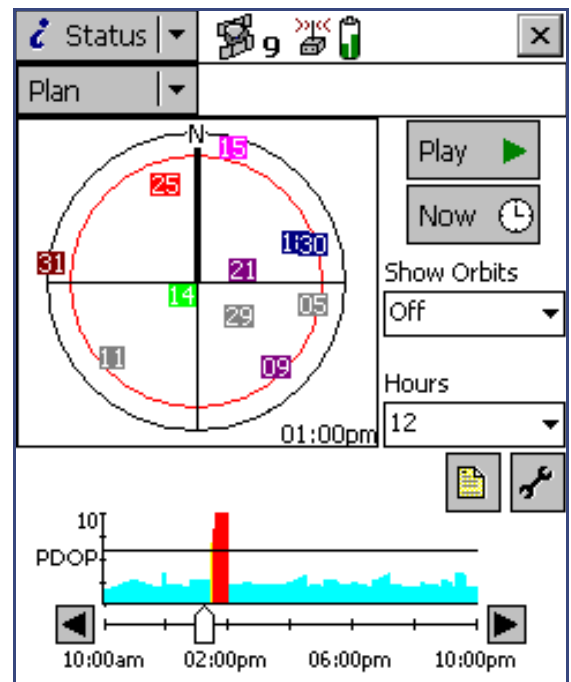

The Plan screen includes a **Planning skyplot**, **Message line**, and a **DOP graph**. It also includes the following controls:

- Play
- Now
- Show Orbits
- Hours
- Report
- Setup



More...

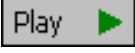
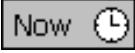

Button	Display	Description
Play		Tap Play to begin playback of a session, or to resume playback after pausing. When the session is playing, the button changes to the Pause button. Tap it to temporarily pause playback. At the end of playback, the button changes to the Home button. Tap it to return to the beginning of the session, ready for playback again.
Now		Tap Now to set the session to the current time. The time shown on the skyplot and position of the slider bar on the DOP graph change to match the current time.
Report		Tap the Report button to create a text file containing details of the current planning session.
Setup		Tap the Setup button to open the GPS Settings form from the Setup section.



Field	Description
Show Orbits	<p>Use this field to select the type of orbit information to display on the skyplot. The options are:</p> <ul style="list-style-type: none"> • Off Do not show any orbit information. • Trails Show an orbit trail for each satellite. During session playback, the trail (a solid line in the same color as the satellite) plots where the satellite has been since the beginning of the session. • Trajectories Show an orbit trajectory for each satellite. At the beginning of playback, each satellite's entire trajectory (a dashed line in the same color as the satellite) is visible, showing where the satellite will be as the session progresses. During session playback, the satellite erases its trajectory as it moves over the plotted positions.



Field	Description
Hours	Select an option from this field to specify how many hours the planning session will cover. The session begins at the last full hour before the current time (for example, if the time is 10:56, the session starts at 10:00) and can cover up to twelve hours.



Planning skyplot

The planning skyplot is similar to the skyplot shown in the **Skyplot** section. The outer black circle indicates the horizon, the inner red circle represents the minimum elevation that you have set, and each satellite that is in view is represented by a box containing the satellite's PRN (**pseudorandom number**). Each satellite is colored for easy identification.

NOTE

Unlike the main skyplot, the planning skyplot shows **all** visible satellites, even if they are below the configured minimum elevation or their current SNR value is too high. To check which satellites are currently being tracked, use the main **Skyplot**.

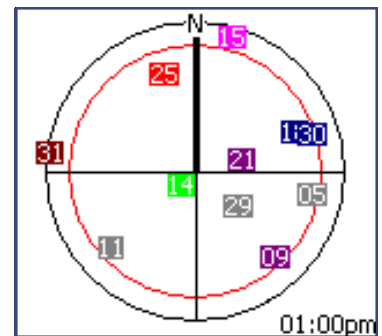

The time displayed in the lower right corner of the planning skyplot indicates the exact time that the skyplot is showing. It matches the position of the slider bar on the **DOP graph**.

When you open the Plan section, the planning skyplot's orientation matches the current heading shown in the main **Skyplot**. The planning skyplot does not rotate as your heading changes, but if your heading becomes locked (for example, if you are not moving fast enough for an accurate heading to be calculated) then the planning skyplot's orientation is updated to this locked heading.



DOP graph

The DOP graph shows the projected PDOP or HDOP values over the specified time period.

The horizontal line indicates the currently configured maximum PDOP or HDOP.

The slider bar shows the time over the selected period in the **Hours** list. Drag the slider bar across

the slider, or tap the left or right arrow button, to view the skyplot for a specific time. As the slider control's position changes, the skyplot and time display change to match the selected time.

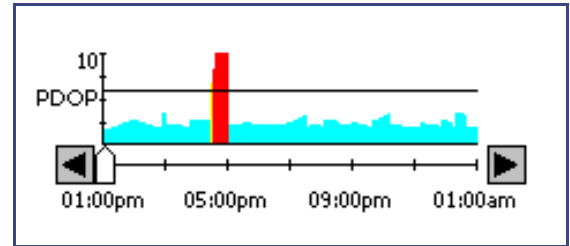

Appearance	PDOP	HDOP
Cyan bar	< 4	< 2.5
Green bar	4 – 6	2.5 – 4
Yellow bar	6 – 8	4 – 5.5
Red bar	> 8	> 5.5
Blank with black left and right borders	Not enough satellites are available to compute a position.	



Message line

The message line below the planning skyplot in the **Plan** screen displays any error or warning messages. Messages only appear when there is a problem or a condition you should be aware of.

The following messages may appear:

Message	Meaning
Recording almanac	TerraSync is downloading an almanac from the connected GPS receiver.
Need almanac	TerraSync does not have a current almanac of satellite locations.
Need position	The GPS receiver has stopped computing positions.
Heading locked	The GPS receiver is stationary or moving too slowly to calculate an accurate heading. The rotation of the planning skyplot does not reflect the current heading.



Planning a data collection session



TIP If the message **Need almanac** or **Recording almanac** appears in the message line, TerraSync does not have a current almanac of satellite positions. This may occur the first time you connect to GPS after you install TerraSync, or if the GPS receiver has not been used for a while. A current almanac is important when planning a data collection session. Wait until the message disappears before using the Plan section.

Before you use the Plan section, tap the Setup button  to open the **GPS Settings** form from the Setup section, and configure GPS settings to your data collection requirements. Any changes you make are reflected in the planning skyplot and DOP graph in the **Plan** section. For example, if you decrease the minimum elevation, the red circle on the planning skyplot gets larger.

If required, select an option from the Show Orbits list to display orbit trails (past locations within the session) or trajectories (future locations within the session) for each satellite.

Tap the **Play** button  to play back the session automatically. The **Play** button changes to a **Pause** button, the satellites move in the skyplot, and the position of the slider on the DOP graph changes to match the time shown on the skyplot. Tap the **Pause** button at any time to pause playback.

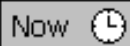

Tap the **Now** button  to show the current time, drag the slider on the **DOP graph** to fast forward to a time of interest, or use the Back  and Forwards  buttons to move in increments of ten minutes. The skyplot changes to show the constellation for the time indicated by the slider position.

To zoom in on a particular time period, use the **Pause** button, slider, or Back and Forwards buttons to stop playback at the time of interest. Select a value from the Hours list. The DOP graph zooms in to show DOP values for the specified number of hours ahead of the selected time.

NOTE The planning skyplot shows all possible satellites, using the almanac received from satellite broadcasts. It does not take into account any obstructions, such as buildings or tree canopy, that may block satellites from your line of sight.



Receiver

Status / Receiver

Tap the Subsection list button and select Receiver. The Receiver screen appears. Use this screen to view information about the GPS receiver.

The Receiver screen contains the following fields:

- **GPS**
- **Position status**
- **Almanac date**
- **Receiver type**
- **Signal processor version**
- **OmniSTAR ID**
- **Antenna**
- **Carrier time**
- **Battery**
- **Navigation version**
- **LandStar ID**

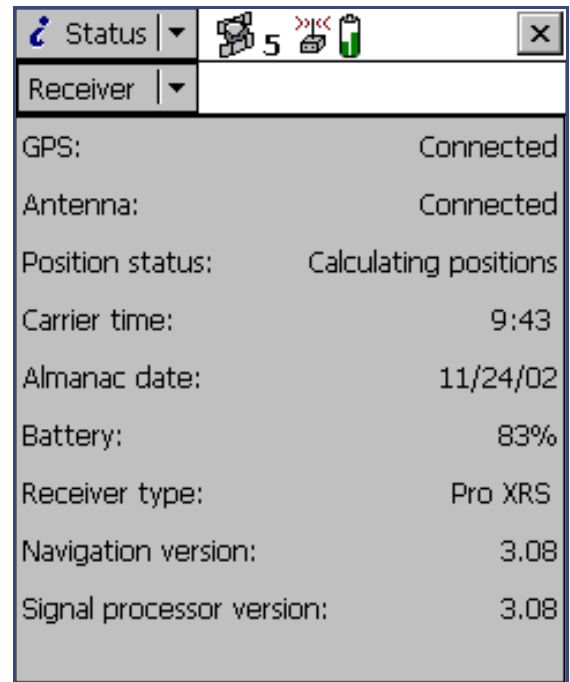

[More...](#)



Field	Description
GPS	<p>The current status of the GPS receiver connection. This field shows the text Connected if the TerraSync software is connected to the GPS receiver.</p> <p>If the software is trying to connect to the receiver, the receiver is not connected, or the receiver has no power, one of the following messages appears:</p> <ul style="list-style-type: none"> • Attempting to connect to GPS • GPS is disconnected • No GPS detected. Check cables, batteries etc <p>All other fields on the form (except the Almanac date field) are hidden.</p>
Antenna	<p>The current status of the antenna connection. Displays Connected when the TerraSync software is connected to a GPS receiver and the receiver is connected to a GPS antenna.</p> <p>When no antenna is connected, it displays Not connected, and the antenna icon also appears in the Status bar.</p>

[More...](#)



Field	Description
Position status	<p>An indicator of the GPS status. Possible values are:</p> <ul style="list-style-type: none"> • Calculating positions the receiver is computing GPS position fixes. The current satellite constellation is therefore acceptable. • Poor satellite geometry the current PDOP or HDOP value is greater than the maximum value, so the GPS receiver is not computing GPS positions. • Too few satellites the GPS receiver has acquired satellites, but too few to compute a position. • Unavailable no position is available; for example, if there is no antenna connected to the receiver.
Almanac date	The date of the almanac appears in this field.
Carrier time	The time elapsed, in minutes and seconds, since the TerraSync software began logging the current block of carrier data.
Battery	The current level of charge in the GPS receiver's battery. This value appears as a percentage.

[More...](#)



Field	Description
Receiver type	The name of the receiver model currently connected to your field computer. The TerraSync software shows the internal name supplied by the receiver, which may not exactly match the name you use for the receiver.
Navigation version	The version number of the navigation firmware installed in the connected GPS receiver.
Signal processor version	The version number of the signal processing firmware installed in the connected GPS receiver.
LandStar ID	<p>The activation code for the LandStar satellite differential service. You need this code when contacting your LandStar provider for activation.</p> <p>NOTE If the connected receiver does not support real-time corrections from a satellite differential service, this field does not appear.</p>

[More...](#)



Field	Description
OmniSTAR ID	The activation code for the OmniSTAR satellite differential service. You need this code when contacting your OmniSTAR provider for activation. NOTE If the connected receiver does not support real-time corrections from a satellite differential service, this field does not appear.



Real-time

Status / Real-time

To view real-time information, tap the Subsection list button then select Real-time.

By default, the real-time screen that appears is the **Real-time Summary screen**. Depending on your real-time configuration, the following detailed status screens may also be available:

- **External Source Status screen**
- **BoB Status screen**
- **Integrated Beacon Status screen**
- **Integrated Satellite Status screen**
- **Integrated WAAS Status screen**

Use these screens to view information about the real-time correction sources you have set up.

Use the Status Mode button to move between these real-time status screens. When you tap the Status Mode button, a list of status screens appears. Select an option to open that screen.

Status		Summary	
BoB		Frequency:	303.5 kHz
		State:	Lock
		SNR:	5.0
 Integrated Satellite		In Use	
		Service Provider:	OmniSTAR
		Frequency:	1558.510 MHz
		State:	Lock
		SNR:	5.0



Real-time Summary screen

Status / Real-time / Summary

The Real-time Summary screen contains a heading for each real-time source you have set up. This heading shows the name of the source. The headings are listed in the order of your choices in the **Real-time Settings** form in the Setup section.

The real-time source currently in use for real-time corrections has an icon beside its name. The icon used matches the icon that appears in the status bar, to provide a quick indicator of the real-time source in use.

If the icon is not shown, the TerraSync software is either waiting for real-time corrections to resume, or is logging uncorrected positions. The real-time icon in the status bar also flashes to indicate that real-time corrections are not available.

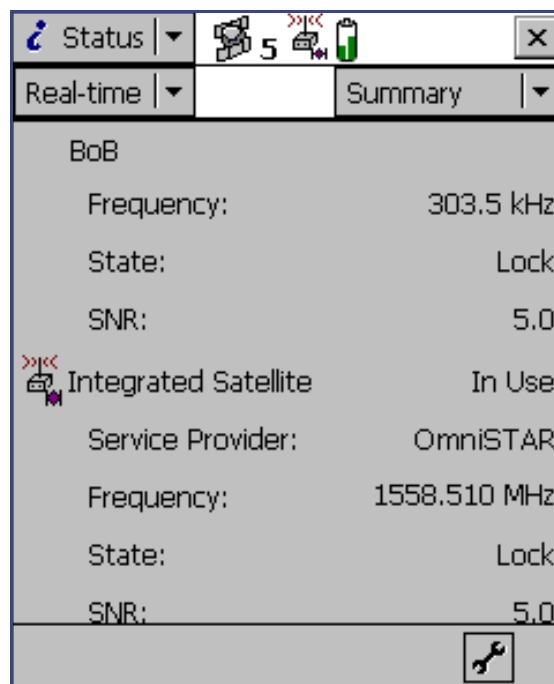

Brief summary information on each real-time source is included in this screen:

- **External Source summary fields**
- **BoB summary fields**
- **Integrated Beacon summary fields**
- **Integrated Satellite summary fields**
- **Integrated WAAS summary fields**

For full status information on any source you have configured, tap the Status Mode list button and select the source name.

The screen also includes a **Setup area** for quick access to real-time settings.



External Source summary fields

The following summary fields appear when the External Source option is configured:

- **External Source**

Field	Description
External Source	<p>The status of the External Source. The options are:</p> <ul style="list-style-type: none">• In use this source is being used for real-time corrections.• Waiting this source is configured but a lower-ranked choice is currently in use. The source's status is being monitored and the TerraSync software will switch to this source if it becomes available and it is the highest-ranked available source.• (none) this source is configured but is not being monitored or used. <p>If this is the real-time source that is currently in use, the real-time icon  appears to the left of the field name.</p>



BoB summary fields

The following summary fields appear when a Beacon-on-a-Belt (BoB) receiver is configured as an external source:

- **BoB**
- **Frequency**
- **State**
- **SNR**

Field	Description
BoB	<p>The status of the BoB receiver configured as an External Source. The options are as for the External Source field.</p> <p>If this is the real-time source that is currently in use, the real-time BoB icon  appears to the left of the field name.</p>
Frequency	<p>The current beacon frequency being tracked or locked on to by the BoB receiver.</p>
State	<p>The real-time operating status of the BoB receiver.</p>
SNR	<p>The signal-to-noise ratio of the beacon signal the BoB receiver is tracking.</p>



Integrated Beacon summary fields

The following summary fields appear when the Integrated Beacon option is configured:

- **Integrated Beacon**
- **Frequency**
- **State**
- **SNR**

Field	Description
Integrated Beacon	<p>The status of the Integrated Beacon real-time source. The options are as for the External Source field, with the addition of this option:</p> <ul style="list-style-type: none"> • Not supported the connected GPS receiver does not support real-time corrections from this source. <p>If this is the real-time source that is currently in use, the real-time beacon icon  appears to the left of the field name.</p>
Frequency	The current beacon frequency being tracked or locked on to.
State	The real-time operating status of the integrated beacon receiver.
SNR	The signal-to-noise ratio of the integrated beacon signal being monitored.



Integrated Satellite summary fields

The following summary fields appear when the Integrated Satellite option is configured:

- **Integrated Satellite**
- **Service Provider**
- **Frequency**
- **State**
- **SNR**

Field	Description
Integrated Satellite	<p>The status of the Integrated Satellite real-time source. The options are as for the Integrated Beacon field.</p> <p>If this is the real-time source that is currently in use, the real-time satellite icon  appears to the left of the field name.</p>
Service Provider	The name of the satellite differential service provider the satellite in use belongs to.
Frequency	The current satellite frequency being tracked or locked on to.
State	The real-time operating status of the integrated satellite receiver.
SNR	The signal-to-noise ratio of the satellite signal being monitored.



Integrated WAAS summary fields

The following summary fields appear when the Integrated WAAS option is configured:



- **Integrated WAAS**
- **SNR**

Field	Description
Integrated WAAS	The status of the Integrated WAAS real-time source. The options are as for the Integrated Beacon field. If this is the real-time source that is currently in use, the real-time WAAS icon  appears to the left of the field name.
SNR	The signal-to-noise ratio of the WAAS satellite signal being monitored.



Setup area

At the bottom of each screen in the Status section's Real-time subsection there is a Setup area. The Setup area provides a shortcut to the Setup section's **Real-time Settings** form. To configure real-time settings, tap the Setup button  in the Setup area. The Real-time Settings form opens. Make any changes you require, then tap **OK** to return to the Real-time subsection.

Status		Summary	
BoB	Frequency:	303.5 kHz	
	State:	Lock	
	SNR:	5.0	
 Integrated Satellite	Service Provider:	OmniSTAR	
	Frequency:	1558.510 MHz	
	State:	Lock	
	SNR:	5.0	
			



External Source Status screen

Status / Real-time / External Source

To display the External Source Status screen, tap the Status Mode button in the **Real-time** subsection, then select External Source.

This screen shows detailed information about the external real-time correction source you have set up.

The External Source Status screen contains the following fields:

- **External Source**
- **Last correction**

The screen also includes a **Setup area** for quick access to real-time settings.

NOTE If you have configured a BoB receiver as the external source, the **BoB Status screen** is available instead of the External Source screen.

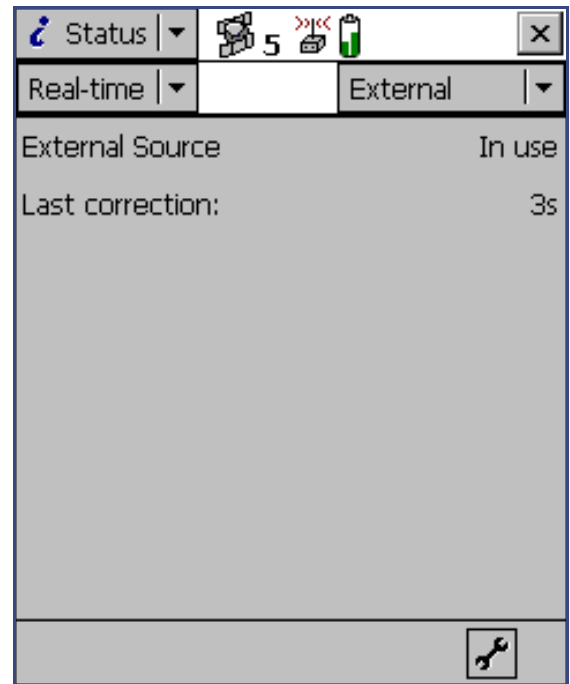

More...



Field	Description
External Source	<p>Indicates the status of this real-time source. The possible values are:</p> <ul style="list-style-type: none"> • In use the external real-time source is currently being used to correct positions in real time. • Waiting a lower-ranked choice is currently being used to correct positions in real time. The external source's status is being monitored and the TerraSync software will switch to the external source if it becomes available and it is the highest-ranked available source. • Not in use the external real-time source is set up but is not currently being used for real-time corrections.
Last correction	The time, in seconds, since the last correction message from this source was received by the GPS receiver.



BoB Status screen

Status / Real-time / BoB

To display the BoB Status screen, tap the Status Mode button in the **Real-time** subsection, then select BoB.

This screen shows detailed information about the BoB receiver you have set up as an external real-time correction source.

The BoB Status screen contains the following fields:

- **BoB**
- **State**
- **Last correction**
- **Filter applied**
- **Diagnostic Information**
- **Frequency**
- **SNR**
- **Beacon mode**
- **BoB battery level**
- **Error Rate**

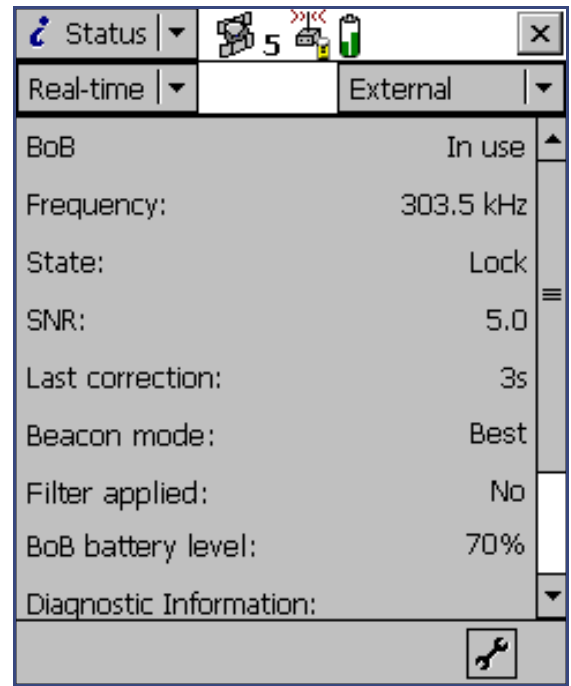

[More...](#)



- **Input Level**
- **Data Rate**
- **Health**

The screen also includes a **Setup area** for quick access to real-time settings.

NOTE If you have configured an external source which is not a BoB receiver, the **External Source Status screen** is available instead of the BoB Status screen.

[More...](#)



Field	Description
BoB	<p>Indicates the status of the BoB receiver. The possible values are:</p> <ul style="list-style-type: none"> In use the BoB receiver is currently being used to correct positions in real time. Waiting a lower-ranked choice is currently being used to correct positions in real time. The BoB receiver status is being monitored and the TerraSync software will switch to BoB if it becomes available and it is the highest-ranked available source. Not in use the BoB receiver is set up but is not currently being used for real-time corrections. Not supported the connected GPS receiver does not support real-time corrections from a BoB receiver.
Frequency	The current beacon station frequency being tracked or locked on to by the BoB receiver.

More...



Field	Description
State	<p>The state of the BoB receiver. The possible values are:</p> <ul style="list-style-type: none"> Search Track Lock Idle On Off
SNR	The signal-to-noise ratio, in decibels, of the beacon signal the BoB receiver is monitoring.
Last correction	The time, in seconds, since the last correction message from this source was received by the GPS receiver.
Beacon mode	<p>The mode the BoB receiver is operating in. The options are:</p> <ul style="list-style-type: none"> Best the BoB receiver tracks the best frequency available and automatically switches frequency if a better signal is available. Fixed the BoB receiver tracks only the frequency you specify in the PC-BoB software.
Filter applied	<p>Whether a filter has been applied to the list of frequencies the BoB receiver can track. The options are:</p> <ul style="list-style-type: none"> Yes No

More...



Field	Description
BoB battery level	The remaining battery power of the BoB receiver, as a percentage.
Diagnostic Information	A heading used to group together fields that contain information for troubleshooting the BoB receiver signal.
Error Rate	The RTCM Word Error Rate, which shows the proportion of RTCM words that have parity errors. An error rate of less than 0.1 is acceptable.
Input Level	The intensity level of the electro-magnetic field. This value should be between 10 and 100 dBuV/M.
Data Rate	The data modulation rate from the BoB receiver.
Health	The health of the BoB receiver signal. The possible values are: <ul style="list-style-type: none"> • Healthy • Unhealthy • Not tracked



Integrated Beacon Status screen

Status / Real-time / Integrated Beacon

To display the Integrated Beacon Status screen, tap the Status Mode button in the **Real-time** subsection, then select Integrated Beacon.

This screen shows detailed information about the integrated beacon source you have set up.

The Integrated Beacon Status screen contains the following fields:

- **Integrated Beacon**
- **State**
- **Last correction**
- **Error Rate**
- **Data Rate**
- **Frequency**
- **SNR**
- **Diagnostic Information**
- **Input Level**
- **Health**

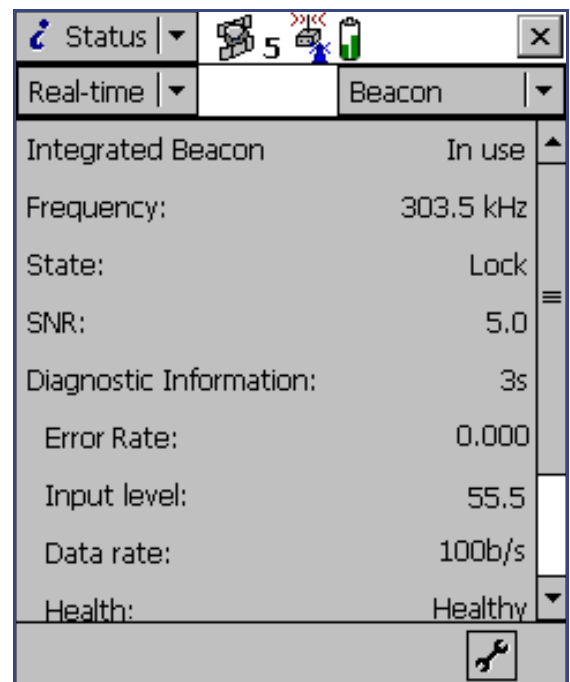

The screen also includes a **Setup area** for quick access to real-time settings.

More...



Field	Description
Integrated Beacon	<p>Indicates the status of this real-time source. The possible values are:</p> <ul style="list-style-type: none"> • In use a beacon is currently being used to correct positions in real time. • Waiting a lower-ranked choice is currently being used to correct positions in real time. The beacon status is being monitored and the TerraSync software will switch to the beacon source if it becomes available and it is the highest-ranked available source. • Not in use a beacon real-time source is set up but is not currently being used for real-time corrections. • Not supported the connected GPS receiver does not support real-time corrections from an integrated beacon receiver.
Frequency	The current beacon frequency being tracked or locked on to.

More...



Field	Description
State	<p>The current state of the integrated beacon receiver. The possible values are:</p> <ul style="list-style-type: none"> • Search • Track • Lock • Idle • On • Off
SNR	The signal-to-noise ratio, in decibels, of the beacon station being tracked. An SNR above 6.0 dB indicates that the signal is usable.
Last correction	The time, in seconds, since the last correction message from this source was received by the GPS receiver.
Diagnostic Information	A heading used to group together fields that contain information for troubleshooting the beacon service.
Error Rate	The RTCM Word Error Rate, which shows the proportion of RTCM words that have parity errors. The error rate should be 0.1 or less.
Input Level	The intensity level of the electro-magnetic field. This value should be between 10 and 100 dBuV/M.

More...



Field	Description
Data Rate	The data modulation rate from the beacon.
Health	The health of the beacon signal. The possible values are: <ul style="list-style-type: none"> • Healthy • Unhealthy • Not tracked



Integrated Satellite Status screen

Status / Real-time / Integrated Satellite

To display the Integrated Satellite Status screen, tap the Status Mode button in the **Real-time** subsection, then select Integrated Satellite.

This screen shows detailed information about the satellite differential service you have set up.

The Integrated Satellite Status screen contains the following fields:

- **Integrated Satellite**
- **Service Provider**
- **Frequency**
- **State**
- **SNR**
- **Last correction**
- **Real-time Service Information**
- **User access**

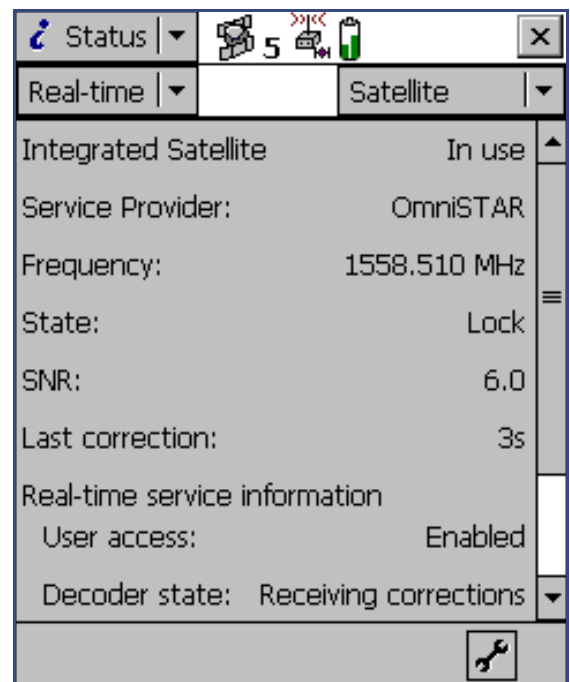

More...



- **Decoder state**
- **Expiration**
- **Diagnostic Information**
- **Quality figure**
- **Age of sync**
- **Decoder version**

The screen also includes a **Setup area** for quick access to real-time settings.



Field	Description
Integrated Satellite	<p>Indicates the status of this real-time source. The possible values are:</p> <ul style="list-style-type: none"> • In use the integrated satellite real-time source is being used to correct positions in real time. • Waiting a lower-ranked choice is currently being used to correct positions in real time. The satellite status is being monitored and the TerraSync software will switch to the satellite source if it becomes available. • Not in use an integrated satellite real-time source is set up but is not currently being used for real-time corrections. • Not supported the connected GPS receiver does not support corrections from an integrated satellite receiver.
Service Provider	<p>The name of the provider of the satellite differential service being used. The possible values are:</p> <ul style="list-style-type: none"> • LandStar • OmniSTAR
Frequency	<p>The current satellite frequency being tracked or locked on to.</p>



Field	Description
State	The current real-time state of the integrated satellite receiver. The possible values are: <ul style="list-style-type: none"> • Search • Lock • Track • Idle
SNR	The signal-to-noise ratio, in decibels, of the selected satellite signal. An SNR above 3.0 dB indicates that the signal is usable.
Last correction	The time, in seconds, since the last correction message from this source was received by the GPS receiver.
Real-time Service Information	A heading used to group together fields that contain information about the integrated satellite subscription.
User access	Indicates whether the selected correction service has been enabled for the GPS receiver. The possible values are: <ul style="list-style-type: none"> • Enabled the service is enabled. • Disabled the activation has expired. • Unknown the service has not yet been activated on this receiver, or the receiver has not yet determined the activation status.

More...



Field	Description
Decoder state	The current status of the satellite activation. The possible values are: <ul style="list-style-type: none"> • Initializing the real-time decoder is initializing. • Receiving corrections the decoder is providing corrections. • No recent data real-time data has not been received from the decoder in the last 10 seconds. • Decoder unavailable the decoder is not available or is not operating correctly. • Decoder reset a reset has been detected in the decoder. • Invalid link the decoder is using a satellite link that is not valid for the subscription. • Invalid region the decoder is being used in a region that is not covered by the current subscription. • Update required the decoder requires an update from the master station before corrections can be provided. • No offshore the decoder is being used in a marine area but the current subscription does not provide for offshore operation.

More...



Field	Description
Expiration	The date on which the satellite differential service subscription expires, or the time remaining until the subscription expires.
Diagnostic Information	A heading used to group together fields that contain information for troubleshooting the satellite service.
Quality figure	The percentage of error-free data received from the integrated satellite in the last data block. This value should be 90% or higher.
Age of sync	The number of seconds since the receiver decoded a data block from the satellite. If this value is greater than 3 seconds, this indicates that the signal from the satellite may not be valid.
Decoder version	The version number of the satellite decoder in the GPS receiver.



Integrated WAAS Status screen

Status / Real-time / Integrated WAAS

To display the Integrated WAAS Status screen, tap the Status Mode button in the **Real-time** subsection, then select Integrated WAAS.

This screen shows detailed information about the WAAS satellite differential service.

The Integrated WAAS Status screen contains the following fields:

- **Integrated WAAS**
- **SNR**
- **Last correction**

The screen also includes a **Setup area** for quick access to real-time settings.

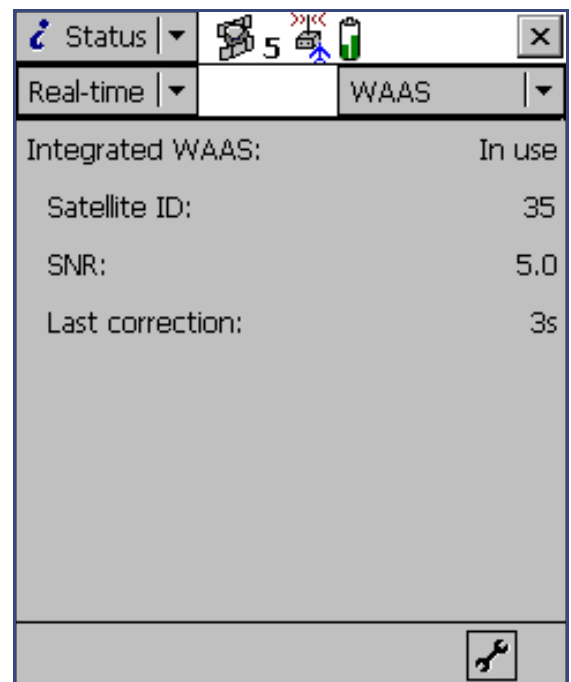

More...



Field	Description
Integrated WAAS	<p>Indicates the status of this real-time source. The possible values are:</p> <ul style="list-style-type: none"> In use: the integrated WAAS real-time source is being used to correct positions in real time. Waiting: a lower-ranked choice is currently being used to correct positions in real time. The WAAS status is being monitored and the TerraSync software will switch to the WAAS source if it becomes available. Not in use: the integrated WAAS real-time source is set up but is not currently being used for real-time corrections. Not supported: the connected GPS receiver does not support corrections from an integrated WAAS receiver.
SNR	The signal-to-noise ratio, in decibels, of the selected WAAS satellite signal. An SNR above 3.0 dB indicates that the signal is usable.
Last correction	The time, in seconds, since the last correction message from this source was received by the GPS receiver.



Sensor

Status / Sensor

NOTE The **TerraSync Standard edition software** does not support external sensors. In TerraSync Standard edition, the Sensor subsection does not appear.

To view sensor information, tap the Subsection list button and then select Sensor.

There is a sensor status screen for each sensor that you can configure. Use these screens to view information about the external sensors that you have set up.

Use the Sensor Mode button to move between the sensor status screens. When you tap the Sensor Mode button, a list of sensors appears. Select an option to open the status screen for that sensor.

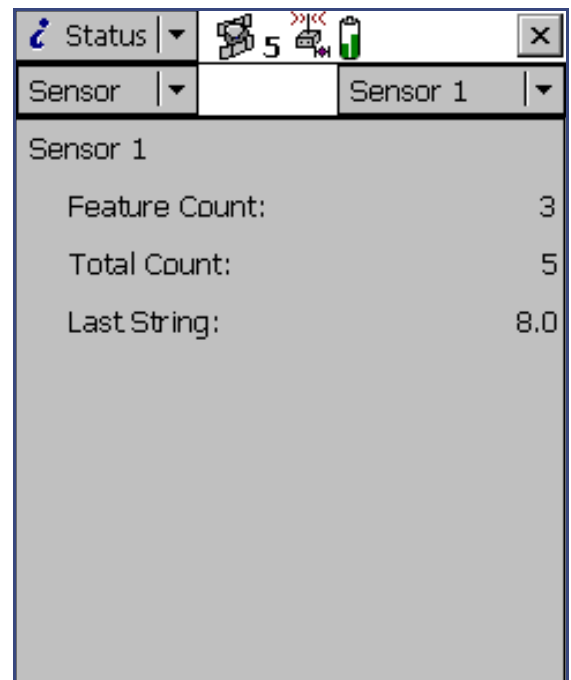

If the sensor is not enabled or connected, the message **Sensor not active** appears. If the sensor is enabled, the status screen contains the following fields:

- **<Sensor name>**
- **Feature Count**
- **Total Count**
- **Last String**

Field	Description
<Sensor name>	The name of the sensor, as defined in the Sensor Properties form .
Feature Count	The number of messages received from the sensor since the beginning of the current feature. This field is not displayed if there is no feature open.
Total Count	The total number of messages received from the sensor.
Last String	The last message string received from the sensor.



Comms

Status / Comms

To view communication port information, tap the Subsection list button and then select Comms.

The Comms screen contains a field for each serial (COM) port that is available on the field computer. Each field's value is the name of the device that is connected to it:

Value	Description
GPS	A GPS receiver is connected.
Laser	A laser rangefinder is connected.
<Sensor name>	An external sensor is connected.
Unknown Application	Another application is using the port.
None	No device is connected on the port.

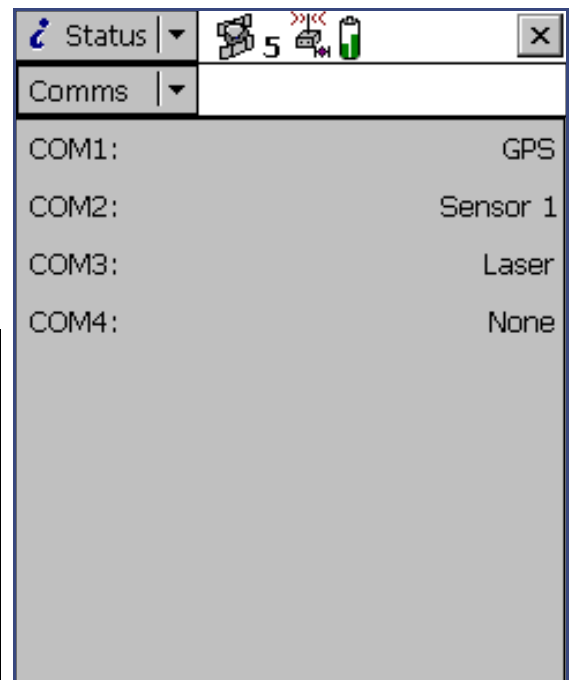

UTC Time

Status / UTC Time

To display the UTC Time screen, tap the Subsection list button and then select UTC Time.

The UTC Time screen shows the current UTC (Universal Time Coordinated) time, calculated from the GPS time reported by the connected GPS receiver. This screen is provided for use with the MediaMapper™ software.

MediaMapper georeferences digital photographs to features collected in TerraSync or other Trimble data collection software. To ensure that each photograph is georeferenced to the correct feature, you need to calibrate the digital camera's internal clock to UTC time. To do this, take a digital photograph of the UTC Time subsection.

MediaMapper compares the UTC time shown in the picture to the picture's time stamp, then calculates the offset between the camera's clock and UTC time.

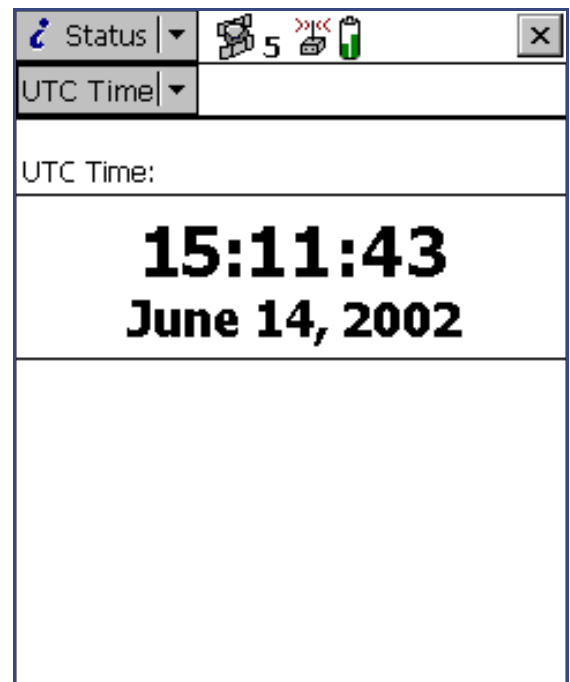

[More...](#)



To ensure an accurate calibration, it is important that the calibration photo displays the current UTC time. Whenever a GPS receiver is connected, TerraSync synchronizes its UTC time display every five seconds with the time reported by the GPS receiver. The UTC time is always up to date when TerraSync is connected to GPS.

If the receiver is disconnected, TerraSync uses the field computer's internal clock to update the UTC time display. However, because the internal clock is not as accurate as the time reported by the receiver, the time displayed becomes less and less accurate. After 24 hours without synchronization (that is, without reconnecting to GPS), the UTC time displayed is no longer accurate enough to be used for calibration, so the UTC time display is replaced with the message **Time not available. Connect to GPS.**

NOTE Before taking a calibration photograph, Trimble recommends that you connect to GPS and wait until the satellite icon with a number beside it  appears in the status bar.



About

Status / About

To display the About screen, tap the Subsection list button and select About.

Use this screen to view information about the installed copy of the TerraSync software.

The About form contains the following:

- **Version number**
- **Organization**
- **Copyright**
- **Licensed to**
- **Serial number**
- **Acknowledgments**

The About subsection also contains the **System Report** button. It lets you create a text file describing your field computer's configuration. If you encounter a problem with your field computer or the TerraSync software, this file (Report.txt) may be requested by a technical support representative to assist with troubleshooting.



Field	Description
Version number	The version and edition of the TerraSync software that is installed.
Licensed to	The name of the person or group this copy of the TerraSync software is licensed to. This is the name you entered during installation.
Organization	The name of the organization this copy of the TerraSync software is licensed to. This is the name you entered during installation.
Serial number	The serial number of this copy of the TerraSync software. This is the serial number you entered during installation.
Copyright	Copyright information.
Acknowledgments	Acknowledgments for the parts of the TerraSync software developed by other companies.



The Setup section

To open the Setup section, tap the Section list button and select Setup. The Setup screen appears:

Use this section to configure the TerraSync software. The Setup screen contains the following:

- **Current Configuration**
- **Lock icon**

It also contains the following buttons:

- **Connect**
- **Change**
- **Logging Settings**
- **Real-time Settings**
- **Units**
- **Reload**
- **Lock/Unlock**
- **GPS Settings**
- **Coordinate System**
- **External Sensors**

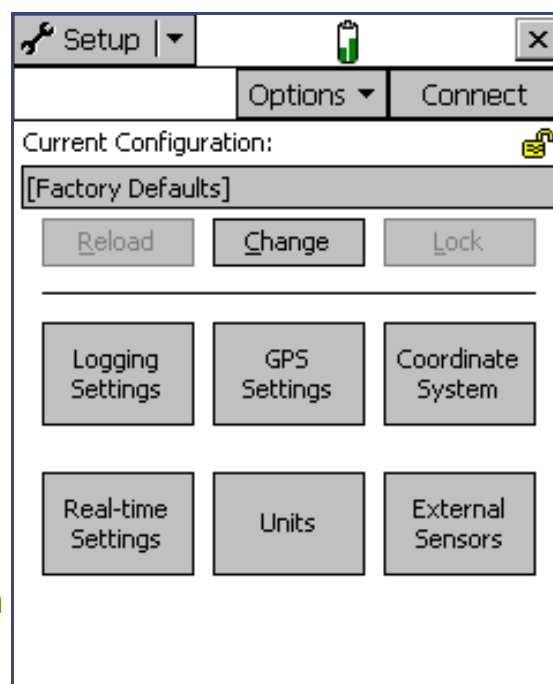

You can also tap **Options** to display the **Setup option list**.

More...



Item	Description
Current Configuration	A read-only field that shows the name of the selected configuration file. If you have changed any settings since loading the configuration file, the text Based Upon is displayed in front of the filename. For more information, see Configuration files .
Lock icon	An icon that indicates whether the loaded configuration file is locked (🔒) or unlocked (🔓).

Use this button ...	to ...
Connect	connect to or disconnect from the GPS receiver. This button is a shortcut to the Connect to GPS and Disconnect from GPS options.
Reload	re-apply the settings from the selected configuration file. Any changes to the configuration will be lost.
Change	open the Choose Configuration form , where you can change to a different configuration file. If the current configuration file specifies that you cannot change configurations, this button is not available.

More...



Use this button ...	to ...
Lock/Unlock	lock the current configuration, or open the Enter Password form where you can unlock the current configuration. For more information, see Configuration files .



Configuration files

A configuration file contains instructions that define, and optionally lock, the configuration of the TerraSync software. The configuration determines how data is collected, entered, and communicated with external devices. You can use configuration files to ensure that data collected by different field crews or on different days is collected in a consistent way.

To create a configuration file, use the Configuration Manager utility in the GPS Pathfinder Office software. For each setting, you can specify a value, and whether it is password-locked. If a setting is password-locked, you cannot change it in the TerraSync software without first unlocking the configuration file by entering the password.

In addition to configuring software settings, a configuration file can also be used to lock some tasks and options. You cannot use a locked option or perform a locked task until you unlock the configuration file.

A locked menu item or option appears grayed out, and has a locked icon (🔒) beside it. This icon also appears beside locked fields in the Setup section, which are read-only.

For more information, see:

- **Reloading a configuration**
- **Resetting to factory defaults**



Changing configuration

Although you can send any number of configuration files to the TerraSync software, only one configuration can be loaded at a time. Provided the loaded configuration file has not locked changing configurations, you can load a different configuration file at any time. You do not have to close any open files or restart the software for the changes to take effect.

To load a different configuration file, tap **Change** in the main Setup screen, select a file in the **Choose Configuration form**, and then tap **Load**.

If the **Change** button is not available, the current configuration file has locked changing configurations. You must unlock it before you can load a different file, or edit password-locked settings. To do this, tap **Unlock** and in the **Enter Password form** enter the configuration file's password.

Once you have unlocked a configuration, you can edit all settings and access all menu items. You can leave the configuration unlocked, or tap **Lock** to lock it again.

If you have made changes to settings in the software, the name of the configuration file in the **Current Configuration** field is prefixed by **Based Upon**.



Reloading a configuration

Once you have changed settings from those defined in the selected configuration file, the configuration name in the main Setup screen's **Current Configuration** field is prefixed by **Based Upon**, and the **Reload** button becomes available.

You can reload a configuration at any time after you make changes to settings. Reloading returns all settings to the values defined in the selected configuration file. To reload a configuration, tap **Reload**. A message appears, asking you to confirm that you want to discard all changes to your settings. Tap **Yes** to continue with reloading.

If you have not transferred any configuration files to the TerraSync software, the Factory Defaults configuration is still available, and you can use the **Reload** button to reset the software to the factory default values. For more information, see **Resetting to factory defaults**.



Resetting to factory defaults

The Factory Defaults configuration file is always available. Provided the current configuration allows you to change configurations, you can reload the Factory Defaults configuration at any time to reset the software to the factory default settings.

The Factory Defaults configuration file is loaded in the same way as any other configuration file. For more information, see [Changing configuration](#) and [Reloading a configuration](#).

The factory default settings include:

- layer colors and any background file that is selected in the Map section
- filtering conditions and logging intervals in the Data section
- the default data dictionary for a new file (reset to Generic)
- options in the Navigation section
- all settings in the Setup section
- window size and pane layout if the field computer displays **Panes**

Resetting does not delete data dictionaries, data files, or coordinate systems.



Setup option list

Setup / Options

In the Setup screen, tap **Options** to display the available options.

The options are:

- **Connect to GPS**
- **Disconnect from GPS**
- **Reset GPS receiver**
- **Activate Integrated Satellite**



Use this option ...	to ...
Connect to GPS	establish a connection with the GPS receiver. If the GPS receiver is already connected, this option is not available.
Disconnect from GPS	disconnect the TerraSync software from the GPS receiver. If the GPS receiver is already disconnected, this option is not available. A message box appears, asking you to confirm that you want to disconnect from GPS. Tap Yes to disconnect.
Reset GPS receiver	reset the GPS receiver to its default settings. TIP If the GPS receiver does not operate as expected after you have used it with a field computer or another data collection application, reset the receiver to clear any settings that may prevent it working properly with the TerraSync software.
Activate Integrated Satellite	enable activation of a satellite differential service using an activation code. This option is only available if a satellite differential service has been set up as a real-time choice, and you are connected to a receiver that supports this service.



Choose Configuration form

Setup / Change

To open the Choose Configuration form, tap **Change** in the Setup screen.

To load a configuration, highlight it in the list and then tap **Load**. The Choose Configuration form closes and the settings in the selected configuration file are applied.

TIP The Factory Defaults configuration file is always available. Load it to reset the software to the factory default settings.

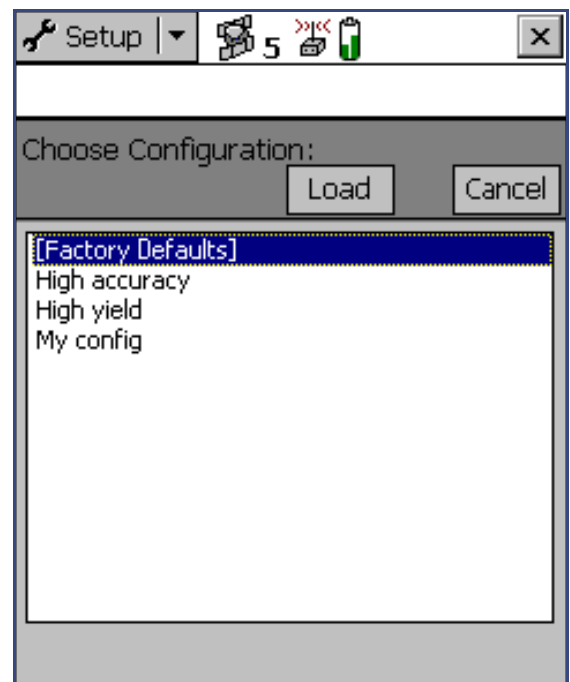

Enter Password form

Setup / Unlock

To open the Enter Password form, tap **Unlock** in the Setup screen.

Enter the password for the selected configuration file. Once you have entered the correct password, you can change settings and use options that are locked in this configuration.

NOTE Passwords are case-sensitive.

If you have forgotten the password, see **You cannot unlock a configuration file**.

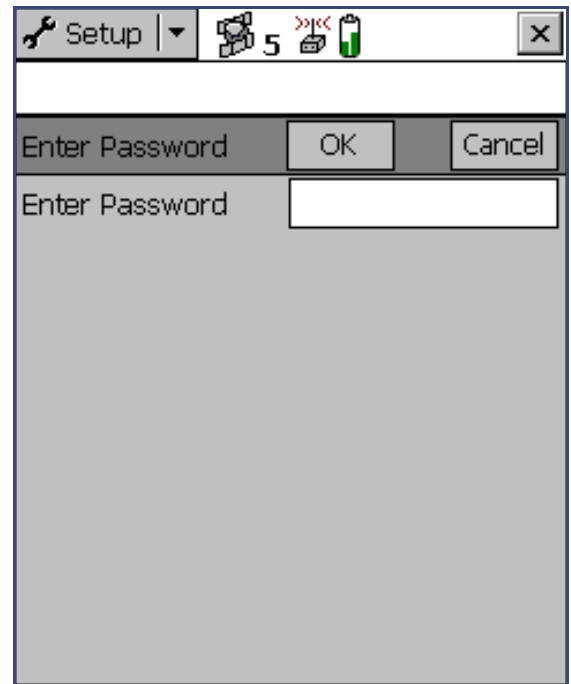

Logging Settings

Setup / Logging Settings

To open the Logging Settings form, tap **Logging Settings** in the Setup screen.

Use this form to configure settings that control what data is stored, and how.

These fields are available in the Logging Settings form:

- **Log Velocity Data**
- **Log SuperCorrect Data**
- **Log QA/QC Data**
- **Antenna Height**
- **Allow Position Update**
- **Confirm End Feature**
- **Filename Prefix**

Between Feature Logging:

- **Style**
- **Interval**

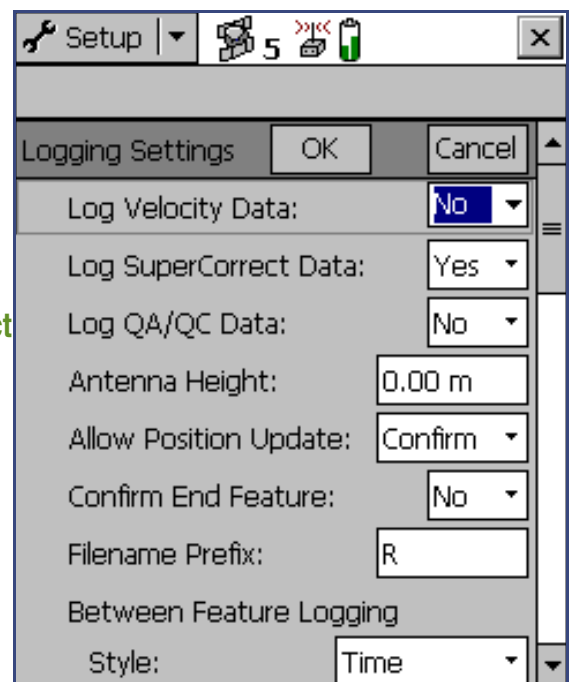

More...



If a data file is open, a separator field for each feature name in the file appears, with the following fields below it:

- **Style**
- **Interval**
- **Accuracy**

Use this field ...	to ...	Default value
Log Velocity Data	specify whether to log velocity records as well as GPS position records. If you log velocity records, you can use velocity filtering in the GPS Pathfinder Office software to reduce “spikes” in your data caused by poor autonomous GPS conditions.	No
Log SuperCorrect Data	specify whether to log SuperCorrect records as well as GPS position records. If you log SuperCorrect records, you can use the SuperCorrect option in the GPS Pathfinder Office software to process the data using different minimum elevation, minimum SNR, and maximum DOP values from those set in TerraSync.	Yes

More...



Use this field ...	to ...	Default value
Log QA/QC Data	specify whether to log any quality assurance/quality control (QA/QC) records that the GPS receiver generates. You can use QA/QC data to filter positions in the GPS Pathfinder Office software before you export the positions to a GIS. Some GPS receivers and versions of receiver firmware do not support logging of QA/QC records. If you have enabled QA/QC logging, then connect to a receiver that does not support this option, a message appears warning you that your current logging settings are not supported. If you open this form while connected to such a receiver, the only option in this field is No.	No
Antenna Height	enter the height of the GPS antenna connected to the GPS receiver. This is used as a vertical offset on each position.	0.00 m

More...



Use this field ...	to ...	Default value
Allow Position Update	specify the conditions under which updating of feature position information is allowed. The items in the drop-down list are: <ul style="list-style-type: none"> • Yes position information for existing features can always be updated • No positions cannot be updated • Confirm confirmation is required before you are allowed to update the position 	Confirm
Confirm End Feature	specify whether to display a confirmation message when you close an updated feature. The message asks you to confirm that you want to end the current feature and save any changes to the feature's attributes or position information. If you set this field to No, no confirmation message appears when you close an open feature.	No
Filename Prefix	define the prefix to be included at the beginning of the default name of each new data file. The prefix may be any alphanumeric string between 1 and 30 characters long.	R

More...



Use this field ...	to ...	Default value
Style	specify the method of measurement for between feature positions. The items in the drop-down list are: <ul style="list-style-type: none"> • Time a position is logged after a specified time has elapsed since the last position logged. • Distance a position is logged once you have traveled a specified distance from the last position logged. 	Time
Interval	specify the logging interval for the between feature positions: <ul style="list-style-type: none"> • If you selected Distance from the Style list, enter the number of meters between logging positions, or select an existing value from the list. • If you selected Time from the Style list, enter the number of seconds between logging positions, or select an existing value from the list. • Select Off to switch between feature logging off. 	Off

More...



Use this field ...	to ...	Default value
Style	specify the method of measurement for the specified feature type. The options are as for Style above. NOTE If the feature is a point feature, this field is set to Time and cannot be changed.	Time
Interval	specify the logging interval for the specified feature type. The options are as for Interval above.	Off
Accuracy	specify whether to log the usual code phase data from the GPS receiver, or to log more detailed but more accurate carrier phase data.	Code



GPS Settings

Setup / GPS Settings

To open the GPS Settings form, tap GPS Settings in the Setup screen. Alternatively, tap the Setup button at the bottom of the **Skyplot** or **Satellite information** screen in **The Status section**.

Use this form to control the precision you require for GPS positions, and to select the port on your field computer the GPS receiver is connected to. There are two configuration modes: Slider and Custom. To change modes, select or clear the check box beside the GPS slider.

GPS slider

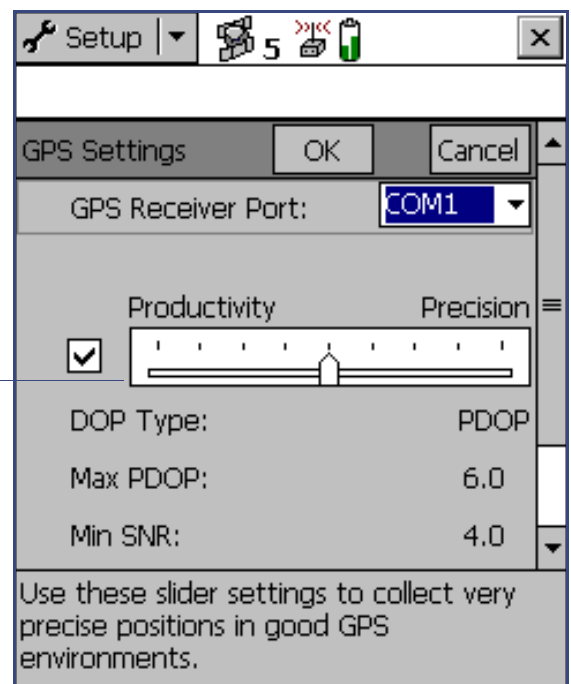

More...



The GPS Settings form contains the following fields:

- **GPS Receiver Port**
- **DOP Type**
- **Min SNR**
- **Slider check box**
- **Max PDOP**
- **Min Elevation**
- **GPS slider**
- **Max HDOP**
- **Velocity Filter**

Use this field ...	to ...	Default value
GPS Receiver Port	specify the port on your field computer the receiver is connected to.	COM1



Use this field ...	to ...	Default value
Slider check box	<p>switch between the Slider and Custom configuration modes.</p> <p>To configure GPS settings in Slider mode, select the Slider check box. The slider control appears on the GPS slider, and the other fields in the form become read-only. The values in these fields change as the slider position changes.</p> <p>To configure GPS settings in Custom mode, clear the Slider check box. The slider control disappears from the GPS slider, and the remaining fields change to editable numeric fields. Enter values in these fields to specify the GPS settings you require.</p>	Selected



Use this field ...	to ...	Default value
GPS slider	<p>configure GPS settings in Slider mode. The GPS slider makes it easy for you to change the level of accuracy without needing to know the best values for each precision setting.</p> <p>The GPS slider is a scale from Low to High. Drag the slider control to the left to decrease the GPS precision. Drag it to the right to increase the GPS precision and exclude positions that do not meet the precision requirements.</p> <p>TIP The GPS slider is the same as the slider in the Setup area in the Skyplot and Satellite information screens. If you change the slider position in the GPS Settings form, it changes in the Setup areas.</p>	



Use this field ...	to ...	Default value
DOP Type	<p>specify whether you want to set a maximum PDOP or maximum HDOP value. Depending on the value you select from this field, either the Max PDOP or the Max HDOP field appears below it.</p> <p>A low DOP value indicates that the visible satellites are widely separated in the sky, which gives better position information. When the DOP value rises above the maximum value, the TerraSync software stops logging GPS positions.</p> <p>This field does not appear in Slider mode.</p>	PDOP



Use this field ...	to ...	Default value
Max PDOP	<p>set the maximum PDOP value, or view the maximum PDOP value for the current slider position.</p> <p>A low PDOP value indicates that the visible satellites are widely separated in the sky, which gives better position information. When the PDOP value rises above the maximum value, the integrated GPS receiver stops logging GPS positions.</p> <p>Specify a lower maximum PDOP to collect fewer, more precise positions. Specify a higher maximum PDOP to collect more, less precise positions.</p> <p>In Slider mode, this field is read-only.</p>	6.0



Use this field ...	to ...	Default value
Max HDOP	<p>set the maximum HDOP value. Specifying a maximum HDOP can give greater productivity than filtering the solutions with a maximum PDOP. Setting a maximum PDOP rejects some positions that have an acceptable HDOP value, because their VDOP value is unacceptable. When you use a maximum HDOP, these positions are accepted.</p> <p>Use a maximum HDOP value when vertical precision is not particularly important, and your productivity would be decreased by excluding positions with a high vertical component in the PDOP value (for example, if you are collecting data under canopy).</p> <p>This field does not appear in Slider mode. In Slider mode, you can only change the maximum PDOP. To set a maximum HDOP, use Custom mode.</p> <p>TIP To achieve the same precision horizontally as you would achieve with a given maximum PDOP, set this value to two-thirds of the maximum PDOP.</p>	4.0



Use this field ...	to ...	Default value
Min SNR	set the minimum SNR value, or view the minimum SNR value for the current slider position. The SNR is a measure of the quality of the signal from a satellite. When a satellite's SNR falls below the minimum value, the TerraSync software stops using that satellite to calculate your position. In Slider mode, this field is read-only.	4.0
Min Elevation	set the minimum elevation, or view the minimum elevation value for the current slider position. Signals from satellites that have a low elevation from the horizon can be of poor quality. The TerraSync software does not use any satellite that is below the minimum value to calculate your GPS position. In Slider mode, this field is read-only.	15°



Use this field ...	to ...	Default value
Velocity Filter	<p>specify whether to apply velocity filtering to GPS positions. Velocity filtering reduces “spikes” in GPS data that are caused by poor GPS conditions. The options are:</p> <ul style="list-style-type: none"> • Auto apply velocity filtering if either of the following is true: <ul style="list-style-type: none"> • the Log SuperCorrect Data option is enabled (all positions are filtered) • at least one valid real-time correction source is selected in the Choice fields, and the last Choice field is set to Wait for Real-time (only real-time positions are filtered) • Off do not apply velocity filtering to any positions. <p>NOTE Trimble recommends that you do <i>not</i> use velocity filtering in good GPS conditions.</p>	Off



As you move the slider control left or right, the values in these fields change accordingly. The values associated with each slider value are as follows:

Position on slider bar	Max PDOP	Min SNR	Min Elevation
1 (Low – far left)	20.0	2.0	5°
2	12.0	2.5	10°
3	8.0	3.0	12°
4	7.0	3.5	14°
5	6.0	4.0	15°
6	5.5	4.5	15°
7	5.0	5.0	15°
8	4.5	5.5	15°
9 (High – far right)	4.0	6.0	15°



Real-time Settings

Setup / Real-time Settings

To open the Real-time Settings form, in the Setup screen tap **Real-time Settings**. Alternatively, tap the Setup button  at the bottom of any real-time status screen in **The Status section**.

Use this form to configure settings that control the sources of **real-time differential GPS** that you use, if any, and how your system communicates with each source.

The Real-time Settings form contains the following fields:

- **Choice 1**
- **Choice 2**
- **Choice 3**
- **Choice 4**
- **Real-time Age Limit**

More...



If you set a Choice field to External, Integrated Beacon, or Integrated Satellite, a Setup button  appears beside that field. Tap the Setup button to open the specified source's settings form, where you can set configuration options that are specific to that choice:

- **External Source Settings form**
- **Integrated Beacon Settings form**
- **Integrated Satellite Settings form**

NOTE No Setup button appears for the Use Uncorrected GPS, Wait for Real-time, or Integrated WAAS selections, because there are no settings to configure for these choices.

It is important that you set up all of your choices correctly, so that when the TerraSync software switches between choices it can continue to receive corrections.

NOTE The Choice 2, Choice 3, and Choice 4 fields only appear if there are further options to choose from. For example, if you choose Use Uncorrected GPS in the Choice 1 field, there are no further valid choices, and the Choice 2, Choice 3, and Choice 4 fields do not appear.

The TerraSync software always uses the highest priority real-time source available, according to your list of preferences. If the source it is currently using becomes unavailable, TerraSync switches to the next choice. Whenever the TerraSync software acquires a higher priority real-time source, it switches back to this source. For example, TerraSync will not use your third choice if your first choice is available.

[More...](#)



The Choice fields let you select up to four options for real-time corrections. However, there are restrictions on the correction combinations you can select. For example, External Source can only ever be selected in the Choice 1 field. Also, the last (least preferred) choice you make must be either Use Uncorrected GPS or Wait for Real-time. Once you select either of these options in a Choice field, there are no further logical choices you can make, so the subsequent Choice fields disappear.

TIP To record uncorrected GPS positions only, without using any real-time corrections, select Use Uncorrected GPS from the Choice 1 field. You can correct these positions back in the office using the GPS Pathfinder Office software, or online using the GPS Pathfinder Express service.

Use this field ...	to ...	Default value
Choice 1	select your preferred source of real-time corrections. The options are: <ul style="list-style-type: none"> • External Source use an external correction source such as a radio or Trimble's Beacon-on-a-Belt (BoB) receiver. 	Integrated Beacon

[More...](#)



Use this field ...	to ...	Default value
	<ul style="list-style-type: none"> Integrated Beacon use corrections from an integrated beacon receiver (Pro XR and Pro XRS receivers only). Integrated Satellite use corrections from an integrated satellite receiver (Pro XRS and Power receivers only). Integrated WAAS use corrections from the WAAS satellite differential service (Pro XR, Pro XRS, or Power receivers with firmware version 1.50 or later and WAAS option enabled, and GeoExplorer CE handhelds, only). Use Uncorrected GPS log autonomous GPS positions without applying real-time corrections. 	

More...



Use this field ...	to ...	Default value
Choice 2	<p>select the source of real-time corrections you want to use when your first choice is not available. The options are as for the Choice 1 field except that External Source is not available, and an additional option is available:</p> <ul style="list-style-type: none"> Wait for Real-time suspend logging until a real-time correction source becomes available. 	Use Uncorrected GPS
Choice 3	<p>specify what the TerraSync software should do when your first and second choices are not available. The options are:</p> <ul style="list-style-type: none"> Use Uncorrected GPS Integrated WAAS Wait for Real-time 	(not displayed)
Choice 4	<p>specify what the TerraSync software should do when none of your other preferred real-time correction sources are available. The options are:</p> <ul style="list-style-type: none"> Use Uncorrected GPS Wait for Real-time 	(not displayed)

More...



Use this field ...	to ...	Default value
Real-time Age Limit	specify the maximum age at which a correction message will be used. A message's age is the time that has elapsed since it was received. The options are: <ul style="list-style-type: none"> • 15 seconds • 20 seconds • 25 seconds • 1 min • 2 min • 4 min 	50 seconds



The following table summarizes the valid combinations of real-time correction sources:

Choice 1	Choice 2	Choice 3	Choice 4
External Source	Integrated Beacon	Integrated WAAS	Use Uncorrected GPS
			Wait for Real-time
		Use Uncorrected GPS	(none)
		Wait for Real-time	(none)
	Integrated Satellite	Integrated WAAS	Use Uncorrected GPS
			Wait for Real-time
		Use Uncorrected GPS	(none)
		Wait for Real-time	(none)
Integrated WAAS	Integrated WAAS	Use Uncorrected GPS	
		Wait for Real-time	
	Use Uncorrected GPS	(none)	
	Wait for Real-time	(none)	
Integrated Beacon	Integrated WAAS	Use Uncorrected GPS	
		Wait for Real-time	
	Use Uncorrected GPS	(none)	
	Wait for Real-time	(none)	



Choice 1	Choice 2	Choice 3	Choice 4
Integrated Satellite	Integrated WAAS	Use Uncorrected GPS	(none)
		Wait for Real-time	(none)
	Use Uncorrected GPS	(none)	(none)
Integrated WAAS	Use Uncorrected GPS	(none)	(none)
	Wait for Real-time	(none)	(none)
Use Uncorrected GPS	(none)	(none)	(none)

You do not have to remember which combinations are valid; the TerraSync software manages this for you by hiding invalid options or Choice fields depending on your previous choices. For example, you cannot use Integrated Satellite if you have already selected Integrated Beacon for a higher choice, so when you select Integrated Beacon in the Choice 2 field, Integrated Satellite is removed from the options for the Choice 3 field.



External Source Settings form

Setup / Real-time Settings /

To open the External Source Settings form, in the Real-time Settings form select External Source from the Choice 1 field, then tap the Setup button  beside the Choice 1 field.

Use this form to configure settings specific to an external real-time source.

The External Source Settings form contains the following fields:

- **Port**
- **Real-time Protocol**
- **Station ID**
- **Receiver Power Output**

TIP

You cannot use the settings in this form to change settings on the Beacon-on-a-Belt (BoB) receiver.

To change BoB receiver settings, use the PC-BoB software that is supplied with the receiver.

More...



Use this field ...	to ...	Default value
Port	<p>specify the port the external correction source connects to. The external source should always be connected to the GPS receiver, not the field computer.</p> <p>To configure communication settings for the port, tap the Setup button  beside this field.</p>	Receiver Port
Real-time Protocol	<p>Specify the type of real-time correction messages the external source is transmitting:</p> <ul style="list-style-type: none"> • CMR CMR (Compact Measurement Record) is a standard format for transmitting differential GPS corrections from a survey base station to roving GPS receivers. • RTCM RTCM (Radio Technical Commission for Maritime Services) is a standard format for transmitting differential GPS corrections from a base station to roving GPS receivers. 	RTCM

More...



Use this field ...	to ...	Default value
Station ID	<p>select the reference station you want to use to compute real-time corrections from. Select Any to use any available station, or enter a station ID number between 0 and 1023.</p> <p>If you have selected BoB from the Type field, this field is not displayed.</p>	Any

More...



Use this field ...	to ...	Default value
Receiver Power Output	<p>specify whether the connected receiver outputs power. If the connected GPS receiver can be configured to supply power, you can use this field to enable power output for an external device such as a DGPS radio. The options are:</p> <ul style="list-style-type: none"> • Auto Corresponds to the On option for a GPS Pathfinder Power receiver; corresponds to Off for all others. • On Enable power output. • Off Disable power output. <p>WARNING Enabling power output can damage some CE devices. Trimble recommends that you always select the Auto option unless you require power to another external device <i>and</i> have protected your CE device from power supplied by the GPS receiver.</p> <p>For more information, see Receiver power output.</p>	Auto



Receiver power output

Some GPS receivers from the GPS Pathfinder family can output power on their serial ports. This can be useful if you want to supply power to an external device, such as an external radio for real-time differential corrections. However, some field computers cannot accept power supplied on a serial port by a GPS receiver. Supplying power can cause problems with, or even permanent damage to, the field computer.

If you enable power output, power is supplied to both of the GPS receiver's ports. When you select the Auto or On option in the [Receiver Power Output](#) field, TerraSync displays a warning message to remind you that power will be supplied to the field computer and the external device.

If you want to supply power from the GPS receiver to an external device, you must:

- check that the GPS receiver is capable of power output on its serial ports (see the table below).
- enable power output in the [Serial Port Settings form](#).
- connect the CE device to the GPS receiver using a *non-powered* connection. Either use the curly straight-through cable P/N 45052, or connect a null modem adapter (P/N 43197) to a powered cable.
- connect the external device to the GPS receiver using a *powered* connection such as the curly straight-through cable P/N 30236.

[More...](#)



The following table shows the GPS receivers supported by TerraSync and their power output behavior:

GPS receiver	Outputs power	Auto option corresponds to	Comments
GPS Pathfinder Power	Always	On	Power output cannot be disabled, even if you select the Off option. Always protect the CE device using data/power cable PN 45052 or a null modem adapter.
GPS Pathfinder Pro XRS GPS Pathfinder Pro XR GPS Pathfinder Pro XL	Configurable	Off	If power output is required, select On and protect the CE device using data/power cable PN 45052 or a null modem adapter.
GPS Pathfinder Pocket GeoExplorer CE series (GeoXT or GeoXM) Allegro with Pod	Never	Off	These GPS receivers do not output power. When one of these receivers is connected, the On option cannot be selected.



Serial Port Settings form

Setup / Real-time Settings / External Source Settings /

To open the Serial Port Settings form, in the **External Source Settings form** tap the Setup button  beside the Port field.

Use this form to configure communication settings when your external correction source is connected to an external COM port.

NOTE When an application opens the serial port, it controls that port. You cannot access the port or change its settings from another application until the port is closed again. Settings that you define in this form are only applied if the port is not in use by another application.

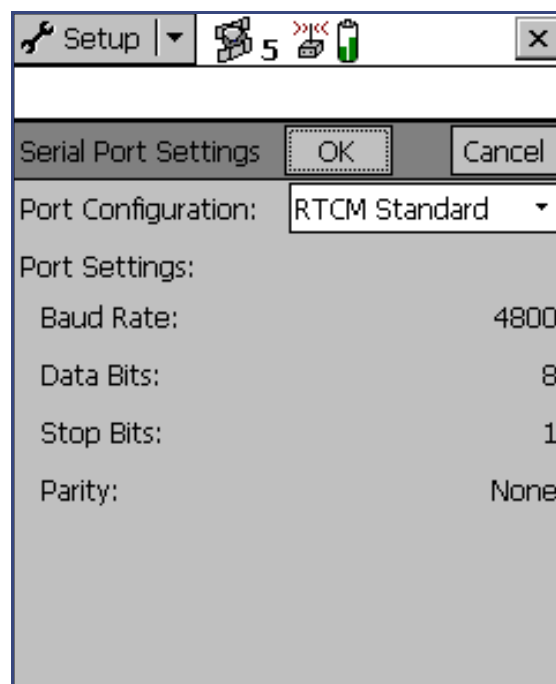

The Serial Port Settings form contains the following fields:

- **Port Configuration**
- **Data Bits**
- **Parity**
- **Baud Rate**
- **Stop Bits**



Use this field ...	to ...	Default value
Port Configuration	<p>Specify the communication settings for the port. There is an option for each communications protocol (NMEA, RTCM, and TSIP) and type of radio supported. These options define preset values which match the radio's default settings. The values defined for each option appear in this form in read-only fields.</p> <p>If the external device allows you to configure port settings, the preset values may not match the device's current settings. If this is the case, or if the device you want to use is not listed, select the Custom option. The remaining fields become available and you can select customized port settings.</p>	Custom



Use this field ...	to ...	Default value
Baud Rate	<p>specify the baud rate the GPS receiver and external source communicate at. The options are:</p> <ul style="list-style-type: none"> • 115K • 38K • 9600 • 2400 • 600 • 58K • 19K • 4800 • 1200 • 300 <p>This field is read-only unless you select Custom from the Type field.</p>	9600
Data Bits	<p>specify the number of data bits used when the external correction source and GPS receiver communicate. The options are:</p> <ul style="list-style-type: none"> • 7 • 8 <p>This field is read-only unless you select Custom from the Type field.</p>	8



Use this field ...	to ...	Default value
Stop Bits	<p>specify the number of stop bits used when the external correction source and GPS receiver communicate. The options are:</p> <ul style="list-style-type: none"> • 1 • 2 <p>This field is read-only unless you select Custom from the Type field.</p>	1
Parity	<p>specify the parity setting used when the GPS receiver and external source communicate. The options are:</p> <ul style="list-style-type: none"> • None • Even • Odd <p>This field is read-only unless you select Custom from the Type field.</p>	None



Integrated Beacon Settings form

Setup / Real-time Settings /

To open the Integrated Beacon Settings form, in the Real-time Settings form select Integrated Beacon from a Choice field, then tap the Setup button  beside the Choice field.

Use this form to configure settings specific to an integrated beacon real-time source.

The Integrated Beacon Settings form contains the following fields:

- **Mode**
- **Frequency**

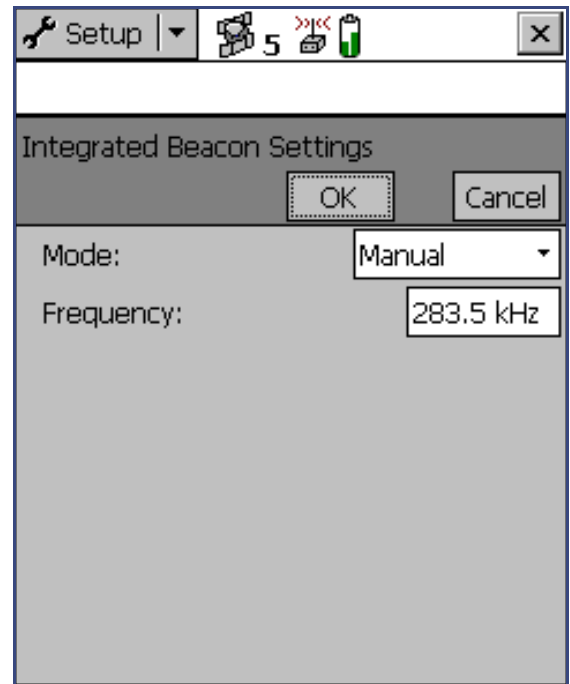



Use this field ...	to ...	Default value
Mode	specify the radiobeacon signal tracking mode to operate the integrated beacon in. The options are: <ul style="list-style-type: none"> • Auto Power the receiver tracks and locks on to the most powerful radiobeacon signal. • Auto Range the receiver tracks and locks on to the nearest radiobeacon signal. • Manual the receiver tracks only the frequency you specify in the Frequency field. 	Auto Range
Frequency	specify the frequency used when you select Manual from the Mode field.	283.5 kHz



Integrated Satellite Settings form

Setup / Real-time Settings /

To open the Integrated Satellite Settings form, in the Real-time Settings form select Integrated Satellite from a Choice field, then tap the Setup button  beside the Choice field.

Use this form to configure settings specific to an integrated satellite real-time source.

The Integrated Satellite Settings form contains the following fields:

- **Service Provider**
- **Frequency**
- **Station Preference**
- **Name**
- **Data Rate**

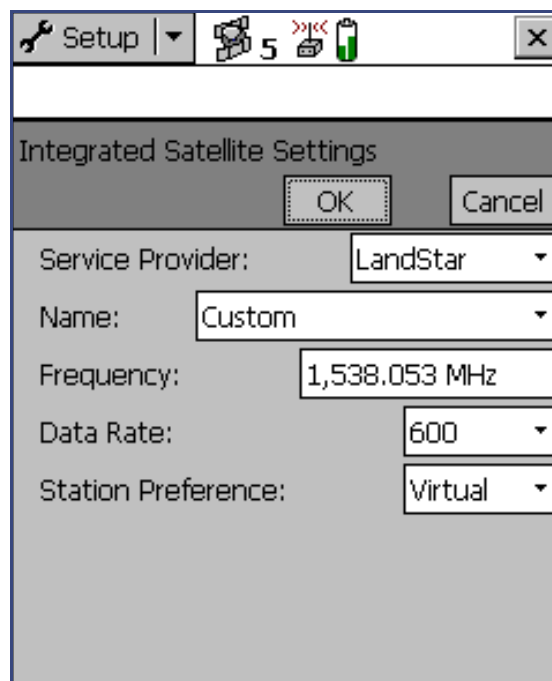

Use this field ...	to ...	Default value
Service Provider	select the satellite differential service provider. The options are: <ul style="list-style-type: none"> • OmniSTAR • LandStar • (blank) 	(blank)
Name	select the satellite used for satellite differential corrections. The options in this list will vary depending on the satellite differential service provider selected.	Custom
Frequency	specify the frequency used when you select Custom from the Name field.	1538.053 MHz
Data Rate	specify the data rate used when you select Custom from the Name field. The options are: <ul style="list-style-type: none"> • 600 • 1200 • 2400 • 4800 	



Use this field ...	to ...	Default value
Station Preference	<p>specify your preferred reference station type when you select Custom from the Name field and LandStar from the Service Provider field. The options are:</p> <ul style="list-style-type: none"> • Virtual a position that is calculated from the center of the reference station network. It provides a reference position based on the approximate position of your roving receiver. • Closest the nearest reference station position. This may be an actual reference station, a calculated reference position (a “cell”), or the center of the reference station network. 	Virtual



Coordinate System

Setup / Coordinate System

To open the Coordinate System form, in the Setup screen tap **Coordinate System**.

Use this form to specify the coordinate system you want the TerraSync software to use to display foreground and background files.

NOTE Data files are stored using the current coordinate system. If you change coordinate system, the current data file’s coordinates are recalculated, which may take some time.

NOTE A background image is referenced to a particular coordinate system and can only be opened in that coordinate system. If you change coordinate system, any open background image is unloaded.

More...



These fields are available in the Coordinate System form:

- **Select By**
- **Zone**
- **Coordinate Units**
- **Site**
- **Datum**
- **Altitude Units**
- **System**
- **Altitude Reference**
- **Display USNG**

Use this field ...	to ...	Default value
Select By	<p>specify how the coordinate system is selected. By default this field is read-only, and shows the text Coordinate system and zone. If you have transferred sites to the TerraSync software, the options are:</p> <ul style="list-style-type: none"> • Coordinate system and zone select a coordinate system and a zone within that system. • Site select a named site. Each site is associated with a coordinate system and zone that you cannot change. 	Coordinate system and zone

More...



Use this field ...	to ...	Default value
Site	<p>If you selected Site from the Select By field, select the site name from this field.</p> <p>This field does not appear if you have not transferred sites to the TerraSync software.</p>	(none)
System	<p>select the coordinate system to be used in the TerraSync software. If you selected Site from the Select By field, this field is read-only.</p>	Latitude/ Longitude
Zone	<p>select the zone in the coordinate system. This field does not appear if the selected coordinate system does not have zones. If you selected Site from the Select By field, this field appears but is read-only.</p>	(none)
Datum	<p>select the datum the selected coordinate system and zone are associated with.</p> <p>If the system can be associated with only one datum, this field is read-only.</p>	WGS 1984
Altitude Reference	<p>specify whether to display height values relative to the geoid (mean sea level, or MSL) or the ellipsoid (height above ellipsoid, or HAE).</p>	Height Above Ellipsoid (HAE)

More...



Use this field ...	to ...	Default value
Coordinate Units	<p>select the unit of measurement to be used for coordinate values. Options in the drop-down list are:</p> <ul style="list-style-type: none"> • Meters • Inches • Kilometers • Nautical Miles • Millimeters • Chains • Centimeters • Feet • Yards • Miles • US Survey Feet • Namibian Meters • Links <p>NOTE This setting is for Northing and Easting distances only. Units for direct measures of distance are controlled by the Distance Units field in the Units form.</p>	(none)
Altitude Units	<p>select the unit of measurement to be used for altitude values. Options in the drop-down list are as for the Coordinate Units field.</p>	Meters

More...



Use this field ...	to ...	Default value
Display USNG	<p>specify the level of precision for northing and easting values when displaying U.S. National Grid (USNG) coordinates. The options are:</p> <ul style="list-style-type: none"> • Off disable the display of USNG values, and display coordinates to 2 decimal places • 10,000 m display USNG coordinates to 2 digits • 1,000 m display USNG coordinates to 4 digits • 100 m display USNG coordinates to 6 digits • 10 m display USNG coordinates to 8 digits • 1 m display USNG coordinates to 10 digits 	Off



Units

Setup / Units

To open the Units form, in the Setup screen tap **Units**.

Use this form to specify the units used for measurements and display.

These fields are available in the Units form:

- **Distance Units**
- **Area Units**
- **Angle Units**
- **Offset Format**
- **North Reference**
- **Magnetic Declination**

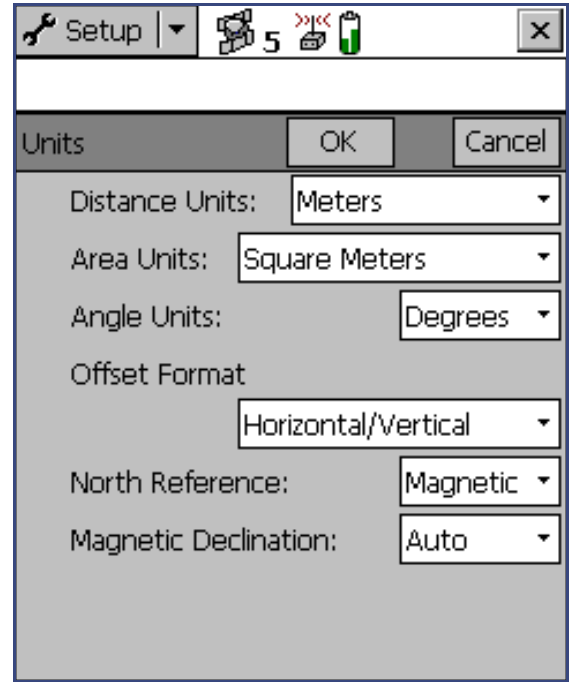

[More...](#)



Use this field ...	to ...	Default value
Distance Units	<p>specify the unit that distances are measured and displayed in. Options in the drop-down list are:</p> <ul style="list-style-type: none"> • Meters • Inches • Kilometers • Nautical Miles • Millimeters • Chains • Centimeters • Feet • Yards • Miles • US Survey Feet • Namibian Meters • Links <p>NOTE This setting is for direct measures of distance only. Units for Northing and Easting distances are controlled by the Coordinate Units field in the Coordinate System form.</p>	Meters

[More...](#)



Use this field ...	to ...	Default value
Area Units	specify the unit that areas are measured and displayed in. Options in the drop-down list are: <ul style="list-style-type: none"> • Square Meters • Square Feet • Square Kilometers • Acres • Hectares • Square Miles 	Square Meters
Angle Units	specify the unit that angles are measured and displayed in. Options in the drop-down list are: <ul style="list-style-type: none"> • Degrees • Mils • Gradians 	Degrees



Use this field ...	to ...	Default value
Offset Format	specify how offset distances are measured. The options are: <ul style="list-style-type: none"> • Horizontal/Vertical the offset is defined as the two-dimensional distance and vertical distance to the feature • Slope/Inclination the offset is defined as the three-dimensional distance to the feature and the inclination of the slope 	Horizontal/ Vertical
North Reference	specify whether north references are relative to true or magnetic north.	True
Magnetic Declination	specify the magnetic declination , in degrees. Select Auto or enter a number in the field. The number must be between -90° and 90° . This field is only available if you have selected Magnetic in the North reference field.	Auto



External Sensors

Setup / External Sensors

NOTE The **TerraSync Standard edition software** does not support external sensors. In TerraSync Standard edition, the External Sensors form is not available.

To open the External Sensors form, in the Setup screen tap **External Sensors**. Use this form to enable and configure external sensors, such as laser rangefinders and geiger counters.

The External Sensors form contains the following fields for each sensor:

- **Check box**
- **<Sensor name>**

It also contains the following button for each sensor:

- **Properties**

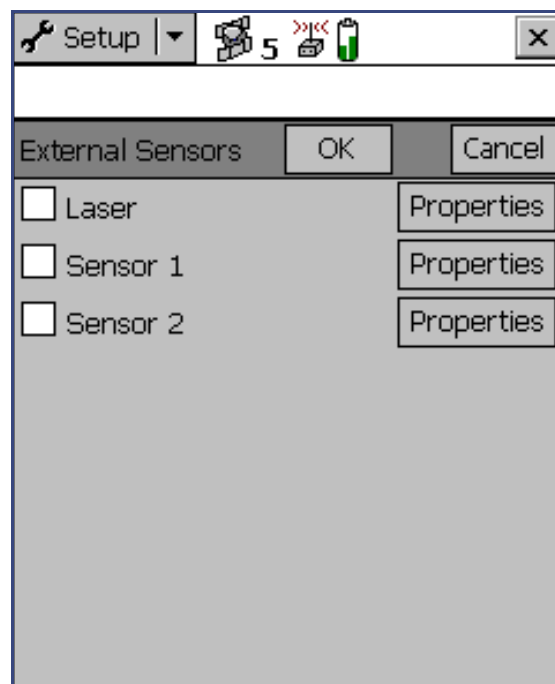

More...



Use this field ...	to ...	Default value
Check box	enable or disable input from the selected sensor or laser rangefinder. When this check box is cleared, any data received from the configured sensor is ignored by TerraSync.	(cleared)
<Sensor name>	identify the configured sensor. You cannot change the name of the Laser sensor. This is a predefined sensor for recording feature offsets. You can change the names of the other two sensors in the Sensor Properties form . TIP To use a laser rangefinder to record attribute values instead of offsets (for example, to record the heights of trees), configure it using Sensor 1 or Sensor 2.	Laser or Sensor #

Use this button ...	to ...
Properties	display the Sensor Properties form for the selected sensor or laser rangefinder, where you can configure communication, data, and logging properties.



Sensor Properties form

Setup / External Sensors / Properties

To open the Sensor Properties form, in the **External Sensors** form tap one of the **Properties** buttons.

Use this form to configure the selected sensor. If Laser is selected, the following fields appear:

- **Port**
- **Baud Rate**

If Sensor 1 or Sensor 2 is selected, the following fields appear:

- **Name**

Communications:

- **Port**
- **Baud Rate**
- **Data Bits**
- **Stop Bits**

[More...](#)



- **Parity**

Data Identification:

- **Prefix String**
- **Suffix String**
- **Max Bytes**
- **Time Out**

Receive Mode:

- **Receive Mode**
- **Request String**
- **Point Feature**
- **Line/Area Feature**
- **Not in Feature**

Data Destination:

- **Data Destination**
- **Attribute Name**

[More...](#)



Use this field ...	to ...	Default value
Name	specify a name for the sensor.	(none)
Port	select the serial (COM) port that the sensor is connected to.	None
Baud Rate	specify the baud rate the field computer and external sensor communicate at. The options are: <ul style="list-style-type: none"> • 115K • 38K • 9600 • 2400 • 600 • 58K • 19K • 4800 • 1200 • 300 <p>If the selected sensor is the Laser sensor, the only options are 4800 and 9600.</p>	9600 (external sensor) or 4800 (laser)
Data Bits	specify the number of data bits used when the field computer and external sensor communicate. The options are: <ul style="list-style-type: none"> • 7 • 8 	8

More...



Use this field ...	to ...	Default value
Stop Bits	specify the number of stop bits used when the field computer and external sensor communicate. The options are: <ul style="list-style-type: none"> • 1 • 2 	1
Parity	specify the parity setting used when the field computer and external sensor communicate. The options are: <ul style="list-style-type: none"> • None • Even • Odd 	None
Prefix String	specify a prefix to be added to the data. The prefix may be up to 30 characters long.	(none)
Suffix String	specify a suffix to be added to the data. The suffix may be up to 30 characters long.	(none)
Max Bytes	set the maximum length of a data message. This value may be up to 242.	(none)

More...



Use this field ...	to ...	Default value
Time Out	set the maximum time that may elapse between receiving characters of the same message. If a character is received after the timeout period has elapsed, it is considered to be the start of a new message. The timeout value may be between 0 and 0.5 seconds.	0.10s
Receive Mode	<p>specify how the TerraSync software receives data from the sensor. The options are:</p> <ul style="list-style-type: none"> • Unsolicited the sensor emits data continuously. Positions are logged at the configured interval for the current feature type, and whenever a sensor record is received. 	Unsolicited

More...



Use this field ...	to ...	Default value
Request String	<ul style="list-style-type: none"> • Requested data is only logged from the sensor when it is requested by TerraSync. You can configure request intervals for each feature type, or use the Trigger <sensor name> option in the Data section to request data when you need it. <p>define the string that TerraSync sends to the sensor to request data.</p> <p>This field only appears if the Receive Mode field is set to Requested.</p> <p>TIP You can include non-printable characters (for example, line feeds) and system commands in the request string. For more information, see Request Codes.</p>	(none)

More...



Use this field ...	to ...	Default value
Point Feature	<p>specify the interval at which data is requested or read from the sensor for point features. The options are:</p> <ul style="list-style-type: none"> • Off data from this sensor is not recorded for point features. • 5s data from this sensor is requested or read every five seconds. • All all data sent by the sensor is read. This option is only available if the Receive Mode field is set to Unsolicited. • Trigger data is requested when the Trigger <sensor name> option is selected in the Data section. This option is only available if the Receive Mode field is set to Requested. <p>You can also enter an interval, in seconds, in this field.</p>	All

More...



Use this field ...	to ...	Default value
Line/Area Feature	specify the interval at which data is requested or read from the sensor for line and area features. The options are as for Point Feature above.	All
Not in Feature	specify the interval at which data is requested or read from the sensor for between feature positions. The options are as for Point Feature above.	All
Data Destination	<p>specify how the sensor data should be saved in the data file. The options are:</p> <ul style="list-style-type: none"> • Uninterpreted the data is stored in the data file in independent UNINTERPRETED_SENSOR_DATA records. • As attribute the data is stored in an attribute of the current feature. Use the Attribute Name field to specify which attribute to use. 	Uninterpreted

More...



Use this field ...	to ...	Default value
Attribute Name	<p>specify the name of the attribute that the sensor data is to be saved in. If the feature does not contain an attribute with this name, the data is ignored.</p> <p>TIP You can store sensor data in a text or numeric attribute. However, if you use a numeric attribute, any data that cannot be interpreted as a number or is not in the attribute's value range will be ignored. To ensure that no data is lost, use a text attribute that is as long as the longest possible message from the sensor.</p>	(not displayed)



Request Codes

To include a non-printable character (for example, a line feed) or a system command in a sensor request string, enter a backslash (\) followed by a hexadecimal code. The following codes are supported:

Code	Value	Code	Value	Code	Value	Code	Value
\00	nul	\08	bs	\10	dle	\18	can
\01	soh	\09	tab	\11	dc1	\19	em
\02	stx	\0a	lf	\12	dc2	\1a	sub
\03	etx	\0b	vt	\13	dc3	\1b	ec
\04	eot	\0c	ff	\14	dc4	\1c	fs
\05	enq	\0d	cr	\15	nak	\1d	gs
\06	ack	\0e	so	\16	syn	\1e	rs
\07	bel	\0f	si	\17	etb	\1f	us

TIP If you enter a single backslash, TerraSync treats the next two characters as hexadecimal. To include a backslash character, enter \\.



TROUBLESHOOTING

This section lists potential problems and describes how to solve them. They are grouped into the following categories:

- **Communications**
- **Field computer**
- **GPS**
- **Real-time**
- **Using the TerraSync software**
- **Position accuracy**



Communications

This section lists possible causes of, and solutions for, the following communication problems:

- **ActiveSync does not connect to the CE device**
- **Data transfer is slow**
- **Your desktop PC does not connect to the CE device**
- **You cannot send or receive data files by e-mail from within TerraSync**



ActiveSync does not connect to the CE device

Possible cause	Solution
The device is not connected securely to the cradle or data cable.	Check cabling and then try to connect again.
ActiveSync has timed out.	Lift the device out of the cradle and then replace it, or unplug its data cable and then plug it in again.
The TerraSync software is trying to connect to the GPS receiver on the same COM port as ActiveSync.	Disconnect from GPS , or exit the TerraSync software.
The serial (COM) port is configured in the TerraSync software for use with a laser rangefinder.	Exit the TerraSync software, or change the selected port in the Laser port field in the Logging Settings form.
An ActiveSync partnership with another CE device is interfering with connection to the device.	In ActiveSync, delete any partnerships with other CE devices. If you are using a TSCe field device or a GeoExplorer CE handheld, use a guest relationship, not a partnership.



Data transfer is slow

Possible cause	Solution
The CE device is not configured to connect at the maximum baud rate available.	Increase the connection speed. For more information, see ActiveSync .

Your desktop PC does not connect to the CE device

Possible cause	Solution
The CE device is not set up to establish a PC connection.	Open the Communications Properties dialog on your CE device. For information on how to do this, refer to the documentation for your CE device. Select the PC Connection tab and check that the Allow connection with desktop computer when device is attached check box is selected.
Another application is using the COM port.	Exit the other application, or disconnect it from the COM port.



You cannot send or receive data files by e-mail from within TerraSync

Possible cause	Solution
TerraSync cannot connect to your ISP because it does not have your account login details.	In the settings for the Inbox service that you are using, specify the login details for connecting to your ISP.
The data files attached to e-mails are not being downloaded from the mail server.	Configure the Inbox service that you are using to download the entire message and any attachments, not just the message header.
The field computer does not support e-mail.	Use the Data Transfer utility to transfer files to or from TerraSync.



Field computer

This section lists possible causes of, and solutions for, the following field computer problems:

- **The field computer does not turn on, or turns off immediately after being turned on**
- **The message Not enough memory appears**
- **The screen is not visible outdoors or in bright light**
- **A file attached to a filename field does not open or play on a desktop computer**
- **A TerraSync data file has been corrupted**



The field computer does not turn on, or turns off immediately after being turned on

Possible cause	Solution
The field computer's batteries are dead.	Replace or recharge the field computer batteries, or power the field computer externally.

The message **Not enough memory** appears

Possible cause	Solution
Not enough memory on the CE device is allocated to programs (because too much is allocated for storage).	Adjust memory allocation. For more information, see Changing memory allocation .
There is not enough free memory on the field computer.	Delete unwanted files.



The screen is not visible outdoors or in bright light

Possible cause	Solution
The screen contrast is too low.	Adjust the screen contrast. For more information, see Adjusting the screen contrast .

A file attached to a filename field does not open or play on a desktop computer

Possible cause	Solution
The file has been recorded in a special file format that is used only under Windows CE or on a specific brand of CE device. For example, there are a number of ways of encoding WAV (.wav) audio files that are specific to one brand of device.	In the software that you use to record or create the file, change the settings to record files in a format that can be read on a desktop computer.



A TerraSync data file has been corrupted

Possible cause	Solution
The field computer was reset or the batteries were removed while the software was logging data.	Open the file in the TerraSync software. The software automatically repairs and rebuilds the file. NOTE If you suspect that a file is corrupted, rebuild it before transferring it to your office computer or sending it by e-mail.



GPS

This section lists possible causes of, and solutions for, the following problems with GPS or your GPS receiver:

- The message **No GPS detected** appears
- The receiver has not acquired a satellite within three minutes of starting the TerraSync software
- The receiver is not able to compute a GPS position within one minute of starting the TerraSync software



The message No GPS detected appears

Possible cause	Solution
The cable connecting the field computer to the GPS receiver has not been connected, has been connected incorrectly, or is faulty.	Check that the cable is connected correctly. If it appears to be correct and all other equipment appears to be correct, the cable may require servicing.
The COM port on the field computer is faulty.	Check that the COM port is undamaged. If it appears to be damaged, the field computer may require servicing.
The GPS receiver's battery is dead, or has not been connected correctly.	Check that the battery is correctly connected and is charged, or connect to an external power source.



The receiver has not acquired a satellite within three minutes of starting the TerraSync software

Possible cause	Solution
The receiver is still looking for satellites.	Check the Satellite information screen to see how many satellites are being tracked by the receiver.
The expected satellites are being obstructed.	The obstruction may be a building, a tree, or a large vehicle. Identify the obstruction and move away from it. GPS does not work indoors.
Your GPS receiver's external antenna (or antenna cable) has not been connected, has been connected incorrectly, or is faulty.	Check that the external antenna is connected correctly. If your receiver still fails to acquire signals from a satellite, then your antenna and/or antenna cable may require servicing.
The receiver has not been used for a very long time, and the almanac stored in the receiver is outdated.	Wait for up to 15 minutes until a new almanac has been recorded. Subsequent restarts should then be rapid.
The receiver has been set to Base mode by another application.	Reset the GPS receiver. In The Setup section , tap Options and select Reset GPS receiver.



The receiver is not able to compute a GPS position within one minute of starting the TerraSync software

Possible cause	Solution
There are not enough satellites available. Four SVs are required to compute a position.	Use mission planning to check that there are sufficient satellites visible at this time.
	In the GPS Settings form, check that the minimum elevation value is not too high.
	In the GPS Settings form, check that the minimum SNR value is not too high.
The current DOP value is too high.	Use mission planning to check for times when the PDOP or HDOP value will be below your configured maximum value.
	In the GPS Settings form, check that the configured maximum DOP value (PDOP or HDOP) is not too low.



Real-time

This section lists possible causes of, and solutions for, the following problems with real-time corrections or correction sources:

- **Not all positions are corrected in real time**
- **The TerraSync software is not using your first choice real-time correction source**
- **Your integrated beacon component (Pro XR or XRS receiver only) does not appear to work**
- **Your integrated satellite component (Pro XRS or Power receiver only) does not appear to work**
- **Your real-time differential correction link does not appear to work**



Not all positions are corrected in real time

Possible cause	Solution
You have chosen to use uncorrected GPS if no real-time corrections are available.	In the last Choice field in the Real-time Settings form, select Wait for real-time.

The TerraSync software is not using your first choice real-time correction source

Possible cause	Solution
Your first choice correction source is not available, so your second or third choice is being used.	In the Real-time screen, check the status of your preferred correction source. Change the configuration in the Real-time Settings form if necessary, or wait until this source is available again.
The correction source you expected is not set up as your preferred source.	In the Real-time Settings form, select your preferred real-time correction source from the Choice 1 field.



Your integrated beacon component (Pro XR or XRS receiver only) does not appear to work

Possible cause.	Solution
You have set the real-time source incorrectly.	In the Real-time Settings form, set one of the Choice fields to Integrated Beacon. If integrated beacon is your preferred correction source, set the Choice 1 field to Integrated Beacon.
You have set the mode or frequency incorrectly.	In the Real-time Settings form, select appropriate options from the Mode and Frequency fields.



Your integrated satellite component (Pro XRS or Power receiver only) does not appear to work

Possible cause	Solution
You have set the real-time source incorrectly.	In the Real-time Settings form, set one of the Choice fields to Integrated Satellite. If integrated beacon is your preferred correction source, set the Choice 1 field to Integrated Satellite.
You have not enabled the integrated satellite component of your receiver.	For information on how to enable your integrated satellite component, refer to the GPS Pathfinder Systems Receiver Manual.
You have entered the incorrect provider, satellite, and/or frequency.	In the Real-time Settings form, select appropriate options from the Service Provider, Name, and Frequency fields.
Your satellite differential subscription has expired or has not yet been activated.	In the Integrated Satellite Status screen , check the expiry date of your satellite differential subscription. For information on how to renew or acquire a subscription, refer to the GPS Pathfinder Systems Receiver Manual.



Your real-time differential correction link does not appear to work

Possible cause	Solution
Your telemetry link has been incorrectly installed, powered, cabled or configured.	Install the telemetry link as specified by the supplier. Consult the supplier if necessary.
You have set the station ID incorrectly.	In the Real-time Settings form, check that you have set the Station ID field correctly.
You have configured the real-time settings incorrectly.	In the Real-time Settings form, check that the settings under the External Source heading match the telemetry link and the transmitted RTCM data stream.



Using the TerraSync software

This section lists possible causes of, and solutions for, the following operational problems:

- You cannot update a feature, add new features, or open a data file
- You cannot change settings or use some menu items
- You cannot unlock a configuration file
- Automatically generated time attributes are incorrect
- File dates are incorrect
- Some or all features are missing from the Update Features screen or the Map section
- The coordinates displayed by the TerraSync software seem to be incorrect
- You cannot select some coordinate system datums, zones, or ellipsoids
- The target icon is not at the location of the feature you selected as the navigation target
- The message The system time of this device does not match GPS time appears



You cannot update a feature, add new features, or open a data file

Possible cause	Solution
You are using the TerraSync Standard edition software , which does not allow you to open imported files. In this edition of the software, any file that you transfer from your office computer, create from Shapefiles, or receive by e-mail is marked Not Usable.	Upgrade to the fully functional TerraSync Professional edition.
The file is already open in the background of the Map section.	Set the map background file to None, or select another file for the map background.
Position updates are not allowed.	Set the Allow Position Update field in the Logging Settings form to Yes or Confirm.



You cannot change settings or use some menu items

Possible cause	Solution
The setting or menu item is locked by the current configuration. A locked icon (🔒) appears beside locked settings and menu items.	Unlock the configuration file.

You cannot unlock a configuration file

Possible cause	Solution
You have forgotten the configuration file's password.	Use the manager's password, TrimbleTerraSync .



Automatically generated time attributes are incorrect

Possible cause	Solution
The field computer's internal clock has been set incorrectly, or the selected time zone is incorrect.	Before you open any data files, use the World Clock utility on your field computer to set your local time and time zone correctly. For more information, refer to the documentation for your field computer.

File dates are incorrect

Possible cause	Solution
The field computer's internal clock has been set incorrectly, or the selected time zone is incorrect.	Before you open any data files, use the World Clock utility on your field computer to set your local time and time zone correctly. For more information, refer to the documentation for your field computer.



Some or all features are missing from the Update Features screen or the Map section

Possible cause	Solution
There is no data file open.	Use the New File screen to create a new file, or the Existing File screen to open an existing file.
There are no features in the file to display.	Open the Collect Features form and collect some features.
The layer in the Map section that the features belong to has been turned off, or the group in the Data section that the features belong to has been hidden.	In The Map section , tap Layers and select Filtered Features, or Unfiltered Features, to display the appropriate layer.
	In the Update Features screen, tap Options and select Show Filtered Features, or Show Unfiltered Features, to display the appropriate group.
The background file in the Map section is turned off or has not been selected.	If the data you want to see is in a background file, use the Background File form to check that the map is set to display this file. Then tap Layers and make sure that the Background option has a check mark beside it.



Possible cause	Solution
Your zoom scale is incorrect.	Check that you are not zoomed in too close or out too far to see your data. If you have distant items to display, the zoom extents of the map will be at a more distant scale.
You are viewing the wrong area in the Map screen.	Use the Pan map tool or the Pan button on the Command bar to pan the display to the appropriate area.
	Use the Zoom Extents option or the Zoom Extents button on the Command bar to zoom to a scale where all features are visible.
The features have been filtered out.	Check the Status bar to see if a filter is active. If the filter icon  is visible, open the Filter By form where you can disable or change the criteria for filters.
The features have been deleted.	Deleted features are never shown in the Map section. In the Update Features screen, highlight a deleted feature (a feature with a line through it), tap Options , and select Undelete.



The coordinates displayed by the TerraSync software seem to be incorrect

Possible cause	Solution
You have selected the wrong coordinate system or zone.	In the Coordinate System form, select the correct coordinate system and zone.
You have selected the wrong coordinate units.	In the Coordinate System form, select the coordinate system, then select the correct coordinate units.
You are using the Latitude/Longitude coordinate system and have selected the wrong datum.	In the System field in the Coordinate System form, select Latitude/Longitude and specify the correct datum.
You are using the UTM coordinate system and have selected the wrong UTM zone or datum.	In the System field in the Coordinate System form, select UTM, then specify the correct zone and datum. The traditional UTM datum for the U.S.A. is NAD-27.
You have defined a custom coordinate system, datum and/or zone incorrectly in the Coordinate System Manager utility in the GPS Pathfinder Office software.	Check the definition of the coordinate system, datum and/or zone carefully.



You cannot select some coordinate system datums, zones, or ellipsoids

Possible cause	Solution
You transferred a single coordinate system to TerraSync, or a coordinate system export file that did not include all the coordinate systems you want. When you transfer coordinate systems to TerraSync, the transferred data overwrites the existing data, so you must make sure you transfer all the coordinate systems you require.	Create a coordinate system export file that contains all the coordinate systems that you want to use, and transfer this file to TerraSync.
The required coordinate system files have been deleted from your field computer.	Transfer the files from the GPS Pathfinder Office software again.
	To restore default coordinate systems, re-install TerraSync.



The target icon is not at the location of the feature you selected as the navigation target

Possible cause	Solution
You re-recorded the GPS position of the feature, or digitized its position. The navigation target remains at the feature's old position.	Reselect the feature as the navigation target.

The message **The system time of this device does not match GPS time** appears

Possible cause	Solution
The field computer's selected time zone is incorrect.	Before you open any data files, you should use the World Clock utility on your field computer to set your local time zone correctly. For more information, refer to the documentation for your field computer.



Position accuracy

This section lists possible causes of, and solutions for, the following problems with positional accuracy:

- **The accuracy of recorded GPS positions is not as good as you expect**
- **You are unable to differentially correct your GPS positions (either in real time or in postprocessing)**



The accuracy of recorded GPS positions is not as good as you expect

Possible cause	Solution
You did not record sufficient positions to achieve the required accuracy.	In the GPS Pathfinder Office Data Dictionary Editor utility, increase the value in the Minimum Positions field to make sure that the TerraSync software records enough positions. Collect more positions at each point feature.
Your maximum DOP value was too high. If you record positions when the Dilution of Precision is high, this has a detrimental effect on the accuracy of these positions.	In the GPS Settings form, lower your maximum PDOP or HDOP value to make sure that the TerraSync software only logs accurate positions.
Your minimum SNR or elevation value was too low. If you let the receiver use satellites with a low SNR or elevation, this may have a detrimental effect on the accuracy of positions calculated by the receiver.	In the GPS Settings form, raise your minimum SNR and/or elevation value to make sure that the receiver uses satellites with a strong signal.

More...



Possible cause	Solution
You are operating in an area of high multipath.	Move to an area with better GPS coverage and use offsets. Apply velocity filtering. <ul style="list-style-type: none"> Set the Velocity Filter field in the GPS Settings form to Auto to apply velocity filtering to positions as they are recorded. If the Log SuperCorrect Data option is enabled, all positions are filtered. If at least one valid real-time correction source is selected in the Real-time Settings form, and the last Choice field is set to Wait for Real-time, then only real-time positions are filtered. If you intend to postprocess your data, set the Log Velocity Data field in the Logging Settings form to On, and use the velocity filtering option to smooth uncorrected positions when you differentially correct your data in the GPS Pathfinder Office software.
No configured real-time source is available, so TerraSync is using uncorrected positions.	In the last Choice field in the Real-time Settings form, select Wait for Real-time, to use differentially corrected positions only.



You are unable to differentially correct your GPS positions (either in real time or in postprocessing)

Possible cause	Solution
The TerraSync software used satellites that were not visible to the GPS base station.	If the Log SuperCorrect Data option was enabled when the data was collected, use the SuperCorrect feature in the Differential Correction utility to postprocess your data using only those satellites that were common to the rover and base station.
	Make sure that the minimum elevation value in the TerraSync software is set sufficiently high that the software only uses satellites which are also visible to the GPS base station.
You reset the receiver and began logging data before a new almanac was collected, causing TerraSync to use satellites that were not visible to the base station.	Try correcting your data using another base station file.
	Wait until the receiver has collected a new almanac before you log data.
	If the Log SuperCorrect Data option was enabled when the data was collected, use the SuperCorrect feature in the Differential Correction utility to postprocess your data using only those satellites that were common to the rover and base station. This option is enabled by default.



Glossary

Select a word from the following list to view its definition.

- | | | |
|----------------------------|---|--------------------------------|
| almanac | attributes | base station |
| baud rate | bearing | carrier phase |
| C/A code | CE device | Coarse Acquisition code |
| code phase | data dictionary | datum |
| declination | DGPS | differential correction |
| differential GPS | digitizing | Dilution of Precision |
| DOP | ellipsoid | feature |
| field computer | geoid | great-circle distance |
| guest | H/PC Pro | H/PC 2000 |
| HAE | handheld PC (Professional) | handheld PC 2000 |
| HDOP | heading | Height Above Ellipsoid |
| horizon | Horizontal Dilution of Precision | IMS |
| Internet Map Server | ionospheric noise | laser rangefinder |
| latitude | longitude | magnetic declination |
| magnetic north | Mean Sea Level | MSL |
| multipath | NAD-27 | NAD-83 |
| P/PC | palm-size PC | parity |
| partnership | PC | PDOP |
| Pocket PC | Position Dilution of Precision | postprocessing |

[More...](#)



PRN
real-time differential GPS
signal-to-noise ratio
SSF file
UTC
velocity
waypoint

pseudorandom number
rover
site
synchronize
UTM
vertex
Web map server

raster
RTCM
SNR
true north
vector
WAAS
WGS-84



almanac

An almanac is data, transmitted by a GPS satellite, which includes orbit information on all the satellites, clock corrections, and atmospheric delay parameters. The almanac is stored on the CE device. It is used to facilitate rapid acquisition of GPS signals when you turn on the TerraSync software, or when you have lost track of satellites and are trying to regain GPS signals.

attributes

Attributes are the characteristics of a **feature** in a Geographic Information System (GIS). For example, a road may have a name, surface type, or a number of lanes. Each of these factors are attributes of the road feature and could have a range of possible values.

The value chosen to describe a particular feature is called the attribute value. In our example of a road feature, Main Street could be the value of the name attribute and 4 could be the value of the number of lanes attribute.



base station

A base station is a GPS antenna and receiver positioned on a known location specifically to collect data for **differential correction**. Base data needs to be collected at the same time as you collect data on a rover unit. Base stations can be permanent stations that collect base data for provision to multiple users, or a rover unit that you locate on known coordinates for the duration of your datalogging session.

baud rate

A baud is a unit used to measure the speed of electronic code transmissions, generally one bit per second. The higher the baud rate, the faster the transfer of data. However, both the input and output device must be configured to the same baud rate for data to be successfully transferred.



bearing

A bearing is the direction from one point to another, usually measured clockwise from north. In the TerraSync software, the bearing indicates the direction from your current position to the target.

carrier phase

The time taken for the L1 or L2 carrier signal generated by the satellite to reach the GPS receiver. Measuring the number of carrier waves between the satellite and receiver is a very accurate method of calculating the distance between them.

C/A code

See **code phase**.



CE device

A small, usually palm-size or handheld, computer that is capable of running the Microsoft Windows CE operating system. A CE device usually has a small screen, and limited memory and storage space.

Coarse Acquisition code

See **code phase**.



code phase

(also known as Coarse Acquisition code, or C/A code)

The difference between the **pseudorandom number** code generated by the TerraSync software and the pseudorandom number code coming in from the satellite. The code phase data is used to quickly compute the distance to a satellite and therefore calculate your position.

data dictionary

A data dictionary is a description of the objects to be collected for a particular project or job. It is used in the field to control the collection of the spatial and attribute information about these objects. The elements of a data dictionary could include point, line, and area **features**.



datum

A datum is a mathematical model of the earth's surface. World geodetic datums are typically defined by the size and shape of an **ellipsoid** and the relationship between the center of the ellipsoid and the center of the earth.

Because the earth is not a perfect ellipsoid, any single datum will provide a better model in some locations than others. Therefore, various datums have been established to suit particular regions.

For example, maps in Europe are often based on the European datum of 1950 (ED-50). Maps in the United States are often based on the North American datum of 1927 (**NAD-27**) or 1983 (**NAD-83**).

All GPS coordinates are based on the **WGS-84** datum surface.

For more information, refer to the Mapping Systems General Reference or see **Coordinate systems**.

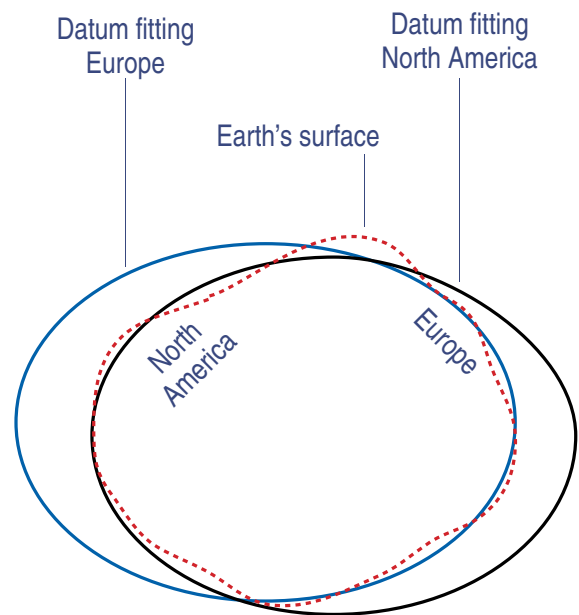

declination

See **magnetic declination**.

DGPS

See **real-time differential GPS**.

differential correction

Differential correction is the process of correcting GPS data collected on a **rover** with data collected simultaneously at a **base station**. Because it is on a known location, any errors in data collected at the base station can be measured, and the necessary corrections applied to the rover data.

Differential correction can be done in real time, or after the data has been collected by **postprocessing**.



differential GPS

See [real-time differential GPS](#).

digitizing

The process of creating positions manually by selecting a point on a map.

Dilution of Precision

(DOP)

A measure of the quality of GPS positions, based on the geometry of the satellites used to compute the positions. When satellites are widely spaced relative to each other, the DOP value is lower, and position accuracy is greater. When satellites are close together in the sky, the DOP is higher and GPS positions may contain a greater level of error.



PDOP (Position DOP) indicates the three-dimensional geometry of the satellites. Other DOP values include **HDOP** (Horizontal DOP) and **VDOP** (Vertical DOP), which indicate the accuracy of horizontal measurements (latitude and longitude) and vertical measurements respectively. PDOP is related to HDOP and VDOP as follows:

$$PDOP^2 = HDOP^2 + VDOP^2$$

For more information, refer to the Mapping Systems General Reference.

DOP

See [Dilution of Precision](#).



ellipsoid

An ellipsoid is the three-dimensional shape that is used as the basis for mathematically modeling the earth's surface. The ellipsoid is defined by the lengths of the minor and major axes. The earth's minor axis is the polar axis and the major axis is the equatorial axis.

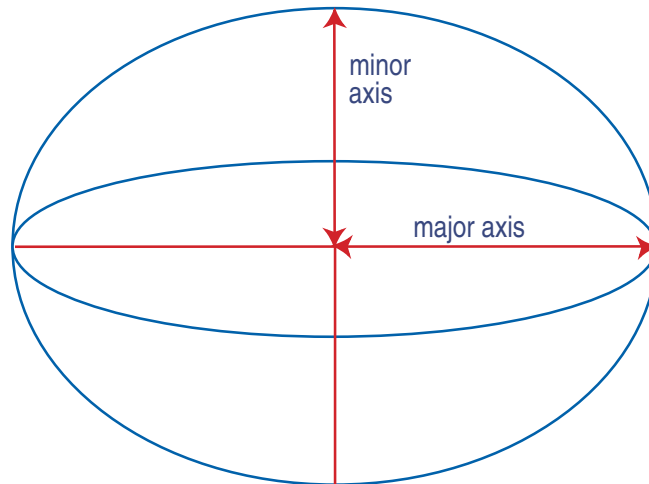

For more information, refer to the Mapping Systems General Reference or see [Coordinate systems](#).



feature

A feature is a physical object or event that has a location in the real world, which you want to collect position and/or descriptive information (**attributes**) about. Features can be classified as points, lines, or areas. For example, a road sign is a point feature, a road is a line feature, and a park is an area feature.

Features are defined in a **data dictionary**.

field computer

In TerraSync documentation, a field computer is any computer that has the TerraSync software installed. The computer must either be a PC running a supported Windows desktop operating system (for example, a laptop or notebook computer running Windows 2000), or be a supported **CE device**.



geoid

A geoid is a 3D surface representing **Mean Sea Level** (MSL) if it was projected to extend through the continents. Unlike an **ellipsoid** or **datum**, which have a symmetrical surface, the geoid undulates perpendicular to the force of gravity.

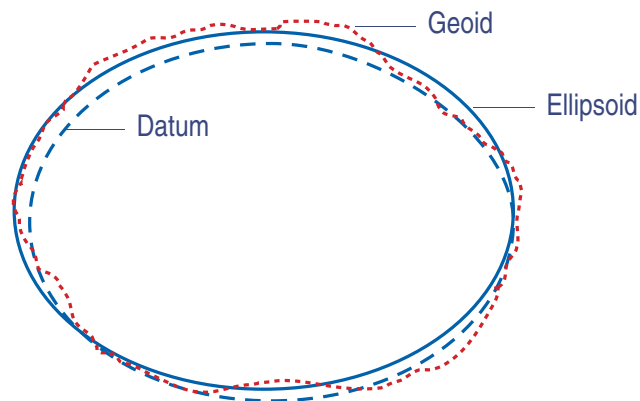

For more information, refer to the Mapping Systems General Reference or see [Coordinate systems](#).



great-circle distance

The great-circle distance is the shortest distance between two points on the surface of a sphere.

guest

A guest connection lets a **CE device** exchange and share information with a desktop computer. You need a **guest** connection or a **partnership** to transfer data between the TerraSync software on your CE device and the GPS Pathfinder Office software on your desktop computer.

When you connect as a guest, you can:

- move or copy files between the two computers
- back up files on your CE device
- install or uninstall programs on your CE device

However, you cannot **synchronize** data between the two computers when you connect as a guest. To synchronize data you must set up a partnership.



A guest connection is temporary. When the guest CE device is disconnected from the desktop computer, any settings for the guest connection are lost. The next time you connect the CE device to the desktop computer, you must set the guest connection again.

If the TerraSync software is installed on a **GeoExplorer CE handheld** or **TSCe field device**, Trimble recommends that you use a guest connection to connect your desktop computer. Use a partnership for other types of CE device.

For more information, refer to the ActiveSync Help.

H/PC Pro

See **handheld PC (Professional)**.

H/PC 2000

See **handheld PC 2000**.



HAE

See **Height Above Ellipsoid**.

handheld PC (Professional)

(H/PC Pro)

A lightweight personal computer that is small enough to be carried. H/PC Pros use the Windows CE operating system, which is based on the Windows operating system, but customized for computers with a limited screen size and memory.

A handheld PC is similar to a **palm-size PC**, but is larger, and usually has a keyboard.



handheld PC 2000

(H/PC 2000)

A lightweight personal computer that is small enough to be carried. H/PC 2000 devices use the Windows CE 3.0 operating system, which is based on the Windows operating system, but customized for computers with a limited screen size and memory.

HDOP

See **Horizontal Dilution of Precision**.



Horizontal Dilution of Precision

(HDOP)

Dilution of Precision (DOP) is a measure of the quality of GPS positions, based on the geometry of the satellites used to compute the positions. When satellites are widely spaced relative to each other, the DOP value is lower, and position accuracy is greater. When satellites are close together in the sky, the DOP is higher and GPS positions may contain a greater level of error.

HDOP is a DOP value that indicates the accuracy of horizontal measurements. Other DOP values include VDOP (vertical DOP) and **PDOP** (Position DOP).

The TerraSync software lets you specify either a maximum HDOP value or a maximum PDOP. It uses this maximum value as an upper bound on DOP values. You can configure the desired level of accuracy, and make sure that the positions logged are of a certain quality. When the DOP exceeds this maximum, the TerraSync software stops computing GPS positions.

Using a maximum HDOP is ideal for situations where vertical precision is not particularly important, and your position yield would be decreased by the vertical component of the **PDOP** (for example, if you are collecting data under canopy).

For more information, refer to the Mapping Systems General Reference.



heading

The heading is the direction you are facing or traveling, usually measured clockwise from north.

Height Above Ellipsoid

(HAE)

HAE is a method for referencing altitude. Altitudes expressed in HAE are actually giving the height above the **datum**, not the **ellipsoid**. GPS uses the **WGS-84** datum and all heights are collected in relation to this surface. It is important to use the same datum when comparing altitudes in HAE.

horizon

The line at which the earth and sky seem to meet.



IMS

See **Web map server**.

Internet Map Server

(IMS)

See **Web map server**.

ionospheric noise

The effects that the ionosphere has on GPS signals. The ionosphere is the band of charged particles 100 to 200 kilometers (60 to 125 miles approximately) above the surface of the earth.



laser rangefinder

An instrument that uses a laser beam to accurately measure the distance to a target. Some rangefinders also measure the **bearing** to the target. Use a laser rangefinder to measure offsets when you are unable to record positions at the exact location of the feature.

latitude

Latitude is an angular measurement made from the center of the earth to north or south of the equator. It comprises the north/south component of the latitude/longitude coordinate system, which is used in GPS data collection.

Traditionally, north is considered positive, and south is considered negative.



longitude

Longitude is an angular measurement made from the center of the earth to the east or west of the Greenwich meridian (London, England). It comprises the east/west component of the latitude/longitude coordinate system, which is used in GPS data collection.

Traditionally, east is considered positive, and west is considered negative.

magnetic declination

Magnetic declination is the difference between **magnetic north** and **true north**. Declination is expressed as an angle and differs between locations.

magnetic north

A bearing that is relative to magnetic north uses the north magnetic pole as its north reference.



Mean Sea Level

(MSL)

Mean Sea Level is a method of altitude reference. Altitudes expressed in relation to MSL actually give a height above the **geoid**.

It is important to use the same geoid when comparing altitudes in MSL.

MSL

See **Mean Sea Level**.



multipath

Multipath occurs when GPS signals arrive at the receiver having traveled different paths. For example, this may happen if some signals are reflected off a building before reaching the receiver. If a signal takes a longer path it will show a larger distance to the satellite and therefore decrease position accuracy.

For more information, refer to the Mapping Systems General Reference.

NAD-27

North American Datum of 1927. A horizontal **datum** employing the Clarke 1866 **ellipsoid**. Height values of this era are expressed in NGVD (National Geodetic Vertical Datum) of 1929.



NAD-83

North American Datum of 1983. A horizontal **datum** employing the GRS-80 **ellipsoid**. Its geometric definition is almost identical to the **WGS-84**. For GPS purposes, the NAD-83 and WGS-84 datums are identical.

P/PC

See **Pocket PC**.

palm-size PC

A lightweight personal computer that is small enough to fit in your hand or pocket. Palm-size PCs use the Windows CE operating system, which is based on the Windows operating system but is customized for computers with a limited screen size and memory.

The palm-size PC platform has been superseded by the **Pocket PC**.



parity

A digital message is composed of 0's and 1's. Parity is a form of error checking that sums the 0's and 1's of the digital message. A parity error results when one of the bits is changed so that the parity calculated at message reception is not the same as it was at message transmission. Options for parity checking include even, odd, and none.

Typically you should have the same parity setting on your CE device as on the external device you are communicating with.

partnership

A partnership lets a **CE device** exchange and share information with a desktop computer. You need a partnership or a **guest** connection to transfer data between the TerraSync software on your CE device and the GPS Pathfinder Office software on your desktop computer.



A partnership stores information about:

- how to connect to the device
- what types of files you can send and receive
- what files you can **synchronize**, and how to manage synchronization
- how to convert files for transfer

Unlike a guest connection, a partnership is stored on the desktop computer and remains when the CE device is disconnected from the desktop computer.

Trimble recommends that you use a guest connection to connect your desktop computer and a **TSCe field device** running the TerraSync software. Use a partnership for other types of CE device.

For more information, refer to the ActiveSync Help.

PC

In TerraSync documentation, a field computer that is running a supported Windows desktop operating system.



PDOP

See **Position Dilution of Precision**.

Pocket PC

(P/PC)

A lightweight personal computer that is small enough to fit in your hand or pocket. Pocket PCs use the Windows CE 3.0 operating system, which is based on the Windows operating system but is customized for computers with a limited screen size and memory.



Position Dilution of Precision

(PDOP)

Dilution of Precision (DOP) is a measure of the quality of GPS positions, based on the geometry of the satellites used to compute the positions. When satellites are widely spaced relative to each other, the DOP value is lower, and position accuracy is greater. When satellites are close together in the sky, the DOP is higher and GPS positions may contain a greater level of error.

PDOP is a DOP value that indicates the accuracy of three-dimensional measurements. Other DOP values include VDOP (vertical DOP) and **HDOP** (Horizontal DOP).

The TerraSync software lets you specify either a maximum HDOP value or a maximum PDOP. It uses this maximum value as an upper bound on DOP values. You can configure the desired level of accuracy, and make sure that the positions logged are of a certain quality. When the DOP exceeds this maximum, the TerraSync software stops computing GPS positions.

Using a maximum PDOP value is ideal for situations where both vertical and horizontal precision are important.

For more information, refer to the Mapping Systems General Reference.



postprocessing

Postprocessing is the processing of satellite data after it has been collected in order to eliminate error. This involves using PC software to compare data from the rover to data collected at the base station.

Because the base station is on a known location, any errors can be determined and removed from the rover data.

PRN

See **pseudorandom number**.



pseudorandom number

(PRN)

The pseudorandom number is the code of 0's and 1's transmitted by GPS satellites, which appears to be random “noise”, but is actually a complex pattern that can be exactly reproduced. Each satellite has its own unique PRN code, which together are used by the GPS receiver to calculate **code phase** positions.

raster

A raster graphic is a graphical image consisting of rows and columns of dots. The color of each dot is represented by the value of one or more data bits in the image file. A bitmap (.bmp file) is a type of raster image.



real-time differential GPS

(also known as real-time differential correction, DGPS)

Real-time differential GPS is the process of correcting GPS data as you collect it. This is achieved by having corrections calculated at a base station sent to the receiver via a radio link. As the rover receives the position it applies the corrections to give you a very accurate position in the field.

Real-time differential correction is usually applied to **code phase** positions.

rover

A rover is any mobile GPS datalogger collecting or updating data in the field, typically at an unknown location. Data collected on a rover can be differentially corrected relative to base station data.



RTCM

Radio Technical Commission for Maritime Services (RTCM).

A commission established to define a differential data link for the real-time differential correction of roving GPS receivers. There are two types of RTCM differential correction message. However, all Trimble GPS receivers use the newer version 2 RTCM protocol.

signal-to-noise ratio

(SNR)

The signal strength of a satellite is a measure of the information content of the signal, relative to the signal's noise. The typical SNR of a satellite at 30° elevation is between 10.0 and 15.0. The quality of a GPS position is degraded if the SNR of one or more satellites in the constellation falls below 4.0.

The TerraSync software lets you set a minimum SNR value. This value is used to determine whether the signal strength of a satellite is sufficient for that satellite to be used by the GPS receiver. If a satellite's SNR is below the configured minimum SNR, that satellite is not used to compute positions.



site

A site consists of an existing coordinate system plus an extra set of parameters for horizontal and vertical adjustments. Together these provide the best fit of GPS data to a specific area or site. Because the additional corrections are only valid for a limited area, that area is called a **site**, or **local site**.

A coordinate system is designed to apply over a large area and does not provide for variations that occur in local coordinates. When you create a site, you shift coordinates obtained using GPS so that they better fit coordinates in the existing map grid that were obtained using traditional surveying methods.

SNR

See **signal-to-noise ratio**.



SSF file

(Standard Storage Format file)

A Trimble data file that stores GPS data from a mapping receiver. Usually these files have the filename extension .ssf. A corrected SSF file has a .cor or .phs extension; an SSF file created by importing data has the extension .imp.

synchronize

Synchronization is the process where ActiveSync compares information on your CE device with the corresponding information on your desktop computer, and then updates either computer with the latest information.

The data stored by the TerraSync software is not synchronized by ActiveSync. Use the Data Transfer utility in the GPS Pathfinder Office software to transfer data to and from the TerraSync software.

For more information, refer to the ActiveSync Help.



true north

A bearing that is relative to true north uses the north celestial pole as its north reference.

UTC

Universal Time Coordinated.

UTC is a time standard based closely on local solar meantime at the Greenwich meridian (GMT). GPS time is directly related to UTC.

UTM

Universal Transverse Mercator Map Projection.

A special case of the Transverse Mercator projection. Abbreviated as UTM, it consists of 60 north/south zones, each 6 degrees wide in longitude.



vector

A vector graphic is a graphical image consisting of mathematical descriptions of lines, points, and areas.

When you transfer an SSF data file to the TerraSync software as a **background file**, its attribute information is removed, leaving only the vector information. You can view the features in the map, but you cannot select them, view their attributes, or edit them.

velocity

Velocity is essentially a measure of speed that takes into account direction of travel as well as the distance traveled over a period of time.



vertex

A point on a line or area feature where two adjacent segments of the feature join. Each position that you collect for a line or area feature is a vertex of that feature.

WAAS

(Wide Area Augmentation System)

WAAS was established by the Federal Aviation Administration (FAA) for flight and approach navigation for civil aviation. WAAS improves the accuracy and availability of the basic GPS signals over its coverage area, which includes the continental United States and outlying parts of Canada and Mexico.

The WAAS system provides correction data for visible satellites. Corrections are computed from ground station observations and then uploaded to two geostationary satellites. This data is then broadcast on the L1 frequency, and is tracked using a channel on the GPS receiver, exactly like a GPS satellite.

Use WAAS when other correction sources are unavailable, to obtain greater accuracy than autonomous positions. For more information on WAAS, refer to the [FAA website](#).



waypoint

A waypoint is a geographical point that, unlike a feature, holds no attribute information beyond a name and location. Typically, waypoints are used to denote objects whose locations are of primary interest, such as a survey mark. Waypoints are most often used for navigation.

NOTE The TerraSync software does not support waypoints explicitly. However, if you transfer a waypoint file to a CE device running the TerraSync software, it is converted during transfer into a data file which contains only Waypoint point features. You can open this file as a data file or as a background file.

Web map server

An Internet site that lets users download GIS data, background, and other files for a specified geographical area. The TerraSync software can download **raster** background files from a Web map server.



WGS-84

WGS-84 is an abbreviation for World Geodetic System 1984. WGS-84 has superseded WGS-72 as the **datum** used by GPS since January 1987.

The WGS-84 datum is based on the **ellipsoid** of the same name.



Index

Symbols and Numerics

- .bmp files
 - deleting
 - using as background files
- .cse files
- .imp files
- .jpg files
 - deleting
 - using as background files
- .shp files

- .sid files
 - deleting
 - using as background files
- .ssf files
- .tcf files, deleting
- .wav files
 - customizing
 - deleting
- .wld files
- 3D GPS position



A

- About screen
- accelerator keys
- ActiveSync. *See* Microsoft ActiveSync
- adjusting contrast
 - on GeoExplorer CE handheld
 - on TSCe field device
- advanced logging options
- Allegro with pod, power output from
- almanac
 - date
 - definition
- animated skyplot
- antenna height, setting
- antenna icon
 - overview
 - ToolTip
- Antenna is not connected to GPS receiver message

- ArcIMS protocol
- ArcView Shapefiles
 - reading from
 - writing to
- area features
 - collecting
 - collecting point features as well
 - continuing
 - offsets
 - offsets, setting
- associating data dictionary with new data file
- Attempting to connect to GPS receiver message
- attribute entry form
 - for existing feature
 - for new feature
 - options
- attribute values
 - editing
 - filtering by
 - filtering by (tutorial)

[More...](#)

attributes

- adding to data dictionary
- auto-generating
- auto-incrementing
- auto-incrementing options
- definition
- deleting from data dictionary
- editing in data dictionary
- entering values
- menu values
- naming
- storing filenames in
- types
- updating

Authorization form

authorization key

auto-generating

- attributes
- feature labels

auto-incrementing attributes

- overview
- setting options

automatically panning in Map screen

averaged vertices

- overview
- recording



B

background file

- creating from Shapefiles
- downloading from map server
- selecting

Background map layer

backing up data on GeoExplorer CE handheld

backlight icon

backlight on GeoExplorer CE handheld

base files

- logging in TerraSync
- selecting

base station, definition

Batch Processor utility

battery icon

- color
- overview
- ToolTip

baud rate

- communicating with ActiveSync
- definition
- setting
- setting for external sensor

Beacon-on-a-Belt receiver

- configuring
- status
- troubleshooting

Bearing information field

bearing to go arrow

bearing to satellite

bearing, definition

bearing-bearing offsets

- creating
- overview

Between Feature GPS map layer

between feature GPS positions

- displaying on map
- recording



- bitmap files
 - deleting
 - using as background files
- blocks of data
- blue text in Operation Guide
- BoB Status screen
- BoB. *See* Beacon-on-a-Belt receiver
- Br(M)
- Br(T)
- bull's-eye in Close-up screen
- buttons

C

- C/A code, definition
- calibrating
 - digital camera to UTC
 - GeoExplorer CE screen
- calibration photograph
- carrier phase
 - blocks of data
 - configuration
 - definition
 - logging data
 - logging settings
 - minimum number of satellites
 - using to log base files
- carrier time
 - in Receiver status screen
 - in status bar

[More...](#)



- CE device
 - changing memory allocation
 - changing screen contrast
 - connecting to desktop computer
 - definition
 - GeoExplorer CE handheld
 - locking
 - requirements
 - storage cards
 - supported types
 - switching between applications
 - TSCe field device
 - See also* field computer
- cellphone, using to connect to e-mail service
- changing
 - configuration file
 - coordinate system
 - map scale to display all selected layers

- checking
 - equipment before going into the field
 - GPS status
 - real-time status
- Choice fields in Real-time Settings form
- clearing main memory of GeoExplorer CE handheld
- clearing navigation target
 - in Data section
 - in Map section
- close-up range
- Close-up screen
 - close-up range
 - close-up style
 - information fields
 - message line
 - overview
 - tutorial

[More...](#)



- close-up style
 - GPS-centered
 - overview
 - target-centered
- closing
 - data file
 - TerraSync software
- Coarse Acquisition code, definition
- code phase, definition
- Collect Features screen
- collecting
 - area feature
 - line feature
 - new data
 - new data (tutorial)
 - point feature
- color
 - battery icon
 - in the TerraSync software

- map layers
 - map layers, changing
- columns, sorting
- COM ports, status
- command bar
 - overview
 - panning
 - zooming
- Comms screen
- communication ports, status
- communications
 - problems
 - status
- complex offsets
 - bearing-bearing
 - distance-distance
 - triple bearing
 - triple distance

More...



- configuration
 - changing
 - reloading
- configuration files
 - deleting
 - overview
 - troubleshooting
- Configuration Manager utility
- configuring
 - Beacon-on-a-Belt receiver
 - carrier phase data collection
 - coordinate system
 - external correction source
 - integrated beacon
 - integrated satellite
- connect icon
 - overview
 - ToolTip

- connection between CE device and office computer
 - establishing
 - troubleshooting
- connection between PC and office computer,
 - establishing
- Connection Manager utility
- connection speed
- context-sensitive help, accessing
- Continue feature form
- continuing line and area features
 - overview
- contrast, changing
 - on CE device
 - on GeoExplorer CE handheld
 - on TSCe
- coordinate system
 - changing
 - configuring
 - Coordinate System Manager utility
 - datum transformation

More...



- datums
- default geoid in TerraSync
- geoid
- map projection
- problems with
- selecting for import
- selecting when reading from Shapefiles
- selecting when writing to Shapefiles
- transferring
- coordinate system export files
 - creating
 - transferring
- Coordinate System form
- Coordinate System Manager utility
- coordinate systems supplied with the TerraSync software
- copying files
- copyright
- corrupted data files, repairing
- Create Feature button
- creating
 - features from the Map section
 - manual positions
 - new data file
 - new data file (tutorial)
 - project using GPS Pathfinder Office
- criteria for filtering
- critical power level
- current configuration file
- current GPS position
 - icon in Map section
 - in Navigation section
- Custom mode
- customizing sounds



D

- data
 - collecting new features
 - differentially correcting
 - updating existing features
- data collection, planning
- data dictionary
 - adding attributes
 - adding features
 - auto-generating labels
 - creating
 - creating from data files
 - creating from Shapefiles
 - definition
 - deleting attributes
 - deleting features
 - editing
 - editing attributes
 - editing features
 - overview
 - resetting to default
 - selecting
 - selecting (tutorial)
 - transferring to TerraSync
 - unique feature names
- Data Dictionary Editor utility
- data entry
 - date fields
 - filename fields
 - menu fields
 - overview
 - text fields
 - time fields
- data files
 - corrupted
 - creating
 - creating data dictionary from
 - creating from Shapefiles



creating Shapefiles from
exporting to GIS
opening
receiving by e-mail
sending by e-mail
transferring from the field computer
using as background files
viewing in GPS Pathfinder Office

Data section

attribute entry form
clearing navigation target
continuing features
creating a new file
e-mailing files
filtering
list of feature types
list of features in file
logging intervals
logging positions later
opening existing file

overview
reading data dictionaries from files
reading Shapefiles
receiving files by e-mail
reference
resetting filters to defaults
resetting logging intervals to defaults
setting navigation target
setting navigation target (tutorial)
writing Shapefiles

Data Transfer utility

transferring coordinate system export files
transferring files from the field computer
transferring files to the field computer

data update, preparing for
date attributes, adding to data dictionary
date fields
date, of current almanac
dates, incorrect

[More...](#)



datums
available
changing
definition
overview
transformations
declination, definition
decreasing contrast on GeoExplorer CE handheld
decrementing attribute values
default filename
for converted files
for data dictionary files
for data files
default logging settings for all features
delaying logging
overview
tutorial
deleting
.wav files
features (Data section)

features (Map section)
files
files sent via e-mail
deletion status, filtering by
overview
tutorial
Device Lock utility
DGPS, definition
differential correction
definition
selecting base files
tutorial
differential GPS, definition
digital camera, calibrating to UTC time
Digitize mode
leaving
overview
Digitize tool in Map section

[More...](#)



- digitizing
 - definition
 - overview
 - undoing positions
- digitizing icon
 - overview
 - Tooltip
- Dilution of Precision, definition
- Direction Dial screen
 - close-up range
 - heading arrow
 - information fields
 - message line
 - overview
 - tutorial
 - using
- Disk
 - GeoExplorer CE handheld
 - See also* storage card
- display, refreshing (Map screen)
- displaying all map layers
- Distance information field
- distance-bearing offsets
- distance-distance offsets
 - creating
 - overview
- DOP graph
- DOP type, selecting
- DOP, definition
- downloading background file from map server



E

- Elev column, in Satellite information table
- elevation
 - setting minimum value
 - viewing
- elevation mask. *See* minimum elevation
- ellipsoid, definition
- e-mail
 - receiving files by
 - sending files by
- e-mail service
- End Feature button
- Enter Coordinates form
- Enter Password form
- entering manual coordinates for a position
- equipment
 - required for installation on CE device
 - required for installation on different PC
 - required for installation on PC
 - what to check before going into the field
- error messages
- existing file
 - opening
 - opening (tutorial)
- Existing File screen
- exiting the TerraSync software
- Export utility
- exporting, data to a GIS
- extents, zooming to
- external correction source
 - configuring
 - troubleshooting
- external real-time icon
 - overview
 - ToolTip
- External Sensors form
- External Source Status screen



F

Factory Defaults configuration file
factory defaults, resetting to

feature types

- filtering by
- filtering by (tutorial)
- list of

features

- adding to data dictionary
- attaching files to
- attribute entry form
- auto-generating labels
- automatically panning to
- collecting (Data section)
- collecting (Map section)
- collection and update options
- collection options
- continuing

- definition
- deleting (Data section)
- deleting (Map section)
- deleting from data dictionary
- editing in data dictionary
- filtering
- filtering (tutorial)
- logging immediately
- logging interval
- logging later
- marking as updated
- missing
- offsets
- opening for update (Map section)
- opening for update (Navigation section)
- repeating
- segmenting
- selecting in Map screen
- sorting
- troubleshooting

[More...](#)



- undeleting
- unique names
- update options
- update status
- updating
- updating positions

field computer

- battery level
- definition
- troubleshooting
- See also* CE device
- See also* PC

fields, moving between

file management

File Manager screen

file status

filename attributes

- adding to data dictionary
- filling in

filename, default

- for data file created from Shapefile
- for new data dictionary
- for new data file

files

- attaching to features
- copying to memory
- copying to storage card
- corrupted
- creating
- deleting
- deleting after e-mailing
- moving
- naming
- naming converted files
- naming data dictionary files
- opening
- receiving by e-mail
- renaming
- sending by e-mail

[More...](#)



- troubleshooting
- See also* data files
- Filter By form
- filter icon
 - overview
 - ToolTip
- filter settings
- filtered features
 - showing or hiding
 - tutorial
- Filtered Features map layer
- filtered group
- filtering
 - by attribute values
 - by deletion status
 - by feature type
 - by update status
 - overview
 - resetting criteria to defaults
 - setting criteria (Data section)

- setting criteria (Map section)
- setting criteria (tutorial)
- tutorial
- flashing number below satellite icon
- flashing satellite icon
- fonts
- formatting of map layers
- forms
 - data entry
 - moving between fields
 - overview
- full hard reset, of TSCe



G

- Generic data dictionary
- GeoExplorer CE handheld
 - adjusting backlight
 - adjusting volume
 - backing up data
 - calibrating screen
 - clearing main memory
 - connecting to ActiveSync
 - licensing TerraSync software
 - overview
 - power output
 - resetting
 - switching between applications
 - using
 - using TerraSync on

- geoid
 - default
 - definition
 - overview
- geoid files
- georeferencing digital photographs
- GeoXM handheld. *See* GeoExplorer CE handheld
- GeoXT handheld. *See* GeoExplorer CE handheld
- GIS data
 - converting to SSF format
 - exporting to a GIS
 - transferring to TerraSync
 - viewing
- GIS TSCe field device. *See* TSCe field device
- global shortcuts
- glossary links in Operation Guide
- good power level
- GPS data
 - logging options
 - updating



- GPS disconnected message
- GPS Pathfinder Office software
 - using with the TerraSync software
 - viewing data files in
- GPS Pathfinder Office utilities
 - Batch Processor
 - Connection Manager
 - Coordinate System Manager
 - Data Dictionary Editor
 - Data Transfer
 - Export
 - Import
- GPS Pathfinder receivers
 - power output
 - supported
- GPS position information field
- GPS position, current
 - automatically panning to
 - in Navigation section
 - updating in feature with

- GPS positions
 - precision settings
 - recording uncorrected
- GPS receiver
 - battery level
 - connecting to
 - power output
 - status
 - supported types
 - troubleshooting
- GPS settings
 - displayed in Satellite information screen
 - displayed in Skyplot
- GPS Settings form
- GPS slider
 - in Setup area
 - precision settings
 - setting (tutorial)
- GPS status, checking
- GPS trail

More...



- GPS Trail map layer
- GPS, troubleshooting
- GPS-centered close-up style
- graphical screens, overview
- great-circle distance, definition
- green text in Operation Guide
- guest connection
 - definition
 - for CE device
 - for GeoExplorer CE handheld
 - for TSCe

H

- H/PC 2000, definition
- H/PC Pro, definition
- handheld PC (Professional)
 - accessing help
 - definition
- handheld PC 2000
 - accessing help
 - definition
 - TSCe field device
- hard reset
 - of GeoExplorer CE handheld
 - of TSCe
- HDOP
 - definition
 - setting maximum value

More...



HDOP graph
 HDOP information field
 heading
 definition
 direction of travel
 showing on Direction Dial
 heading arrow
 Heading information field
 Heading locked message
 in Navigation section
 in Status section
 Heading not available message
 Height Above Ellipsoid, definition
 height, of antenna
 help

hiding
 filtered features (Data section)
 filtered features (Map section)
 map layers
 unfiltered features (Data section)
 unfiltered features (Map section)
 horizon, definition
 Horizontal Dilution of Precision, definition



I

icons

antenna
 battery
 connect
 digitizing
 filter
 logging
 logging carrier
 logging vertex
 memory
 pause
 real-time beacon
 real-time BoB
 real-time external
 real-time satellite
 real-time WAAS
 satellite

import (.imp) file
 Import utility
 importing data from a GIS
 starting
 Imported file status
 Imported update status
 IMS. *See* Web map server
 Inbox, on CE device
 increasing contrast on GeoExplorer CE handheld
 incrementing attribute values
 information fields
 Bearing
 Distance
 GPS position
 HDOP (Satellite Information screen)
 HDOP (Skyplot screen)
 Heading
 in Satellite Information screen
 in Skyplot
 Navigation section

More...



PDOP (Satellite Information screen)
PDOP (Skyplot screen)
Target
Turn

installation

equipment required
instructions for CE device
instructions for PC
onto TSCe

integrated beacon

configuring
status
troubleshooting

Integrated Beacon Status screen

integrated satellite

configuring
status
troubleshooting

Integrated Satellite Status screen

integrated WAAS

configuring
status
troubleshooting

Integrated WAAS Status screen

internal storage card in TSCe field device

Internet address of Web map server

Internet Map Server. *See* Web map server

Internet, downloading files from

introduction to the TerraSync software

ionospheric noise, definition



J

JPEG files

deleting
using as background files

K

keyboard

on TSCe
on-screen
Trimble numeric

keyboard accelerators

keyboard shortcuts



L

labels

- auto-generating in data dictionary in Data section
- in Map section

landscape orientation

LandStar ID

languages

- installing on CE device
- installing on PC

laser rangefinder

- definition
- using to record offsets

latitude, definition

Layers menu button

layers. *See* map layers

licensing TerraSync software

line features

- collecting
- collecting point features as well
- continuing
- offsets
- offsets, setting
- segmenting

line thickness, in Map section

list buttons

lists

- overview
- sorting
- sorting (overview)

loading configuration

local shortcuts

Lock utility

locked configuration file

locked icon

locked menu items

locked options

More...



locking configurations

Log button

- Data section
- Map section

logging

- advanced options
- carrier phase data
- immediately
- later
- pausing and resuming (Data section)
- pausing and resuming (Map section)
- pausing and resuming (tutorial)
- uncorrected GPS positions

logging carrier icon

- overview
- ToolTip

logging carrier phase data

- settings (Data section)
- settings (Setup section)

logging code phase data

- settings (Data section)
- settings (Setup section)

logging icon

- overview
- ToolTip

Logging interval form

logging intervals

- resetting to defaults
- setting (Data section)
- setting (Setup section)

Logging Settings form

logging style

logging vertex icon

- overview
- Tooltip

longitude, definition

low power level



M

magnetic declination

definition

setting

magnetic north, definition

main memory

backing up

clearing

of GeoExplorer CE handheld

See also RAM

managing files

manual positions

map display, refreshing

map layers

colors

displaying all

formatting

showing or hiding

map points

appearance

automatically panning to

selecting

map projection

Map section

background file

command bar

controlling logging from

creating features from

current position

deleting features from

filtering

map layers

map tools

missing features

navigating in

option list

overview

panning

[More...](#)



reference

scale

selecting features

selecting map points

setting and clearing navigation target

updating features from

zooming

map server

definition

downloading background files from

map tools

Digitize

Pan

Select

Zoom In

Zoom Out

Map Tools list button

Map window (in GPS Pathfinder Office)

displaying attributes in

viewing data in

Mark as updated check box

marking features as updated

overview

tutorial

maximum HDOP, setting

maximum PDOP

setting in Custom mode

setting with GPS slider

Mean Sea Level

definition

geoids

MediaMapper

memory allocation, changing

on CE device

on TSCe

memory icon

overview

ToolTip

menu attributes, adding to data dictionary

menu buttons

[More...](#)



- menu fields
- message line
 - Navigation section
 - Plan screen
 - Status section
- messages
 - Antenna is not connected to GPS receiver
 - Attempting to connect to GPS receiver
 - GPS disconnected
 - Heading locked (Navigation section)
 - Heading locked (Status section)
 - Heading not available
 - in ToolTips
 - No GPS
 - Old navigation
 - Old position
 - Poor satellite geometry
 - pop-up

- Set your navigation target in the Map or Data section
- Start moving
- Microsoft ActiveSync
 - connecting to GeoExplorer CE handheld
 - connecting to TSCe field device
 - connection speed
 - guest connection
 - installing
 - overview
 - partnership
 - required version
 - synchronizing data
 - troubleshooting
- mini Section button
- minimum elevation
 - in Skyplot screen
 - setting with GPS slider
- minimum SNR
 - setting with GPS slider

More...



- missing features
- mission planning
- modem, using to connect to e-mail service
- More... indicator in Operation Guide
- moving around the TerraSync Operation Guide
- moving files
- MrSID files
 - deleting
 - using as background files
- MSL, definition
- multipath, definition

N

- NAD-27, definition
- NAD-83, definition
- navigating
 - around the TerraSync Operation Guide
 - in the Map section (tutorial)
 - in the Navigation section
 - in the Navigation section (tutorial)
- navigation bearing to go arrow
- Navigation options form
- navigation proximity alarm
- Navigation section
 - Close-up screen
 - Direction Dial screen
 - information fields
 - message line
 - option list
 - overview

More...



- reference
- resetting options to defaults
- navigation target
 - clearing (Data section)
 - clearing (Map section)
 - icon
 - problems with
 - setting (Data section)
 - setting (Map section)
 - setting (tutorial)
- nesting. [See](#) continuing line and area features
- network, using to connect to e-mail service
- new data dictionary file, default filename
- new data file
 - creating
 - creating (tutorial)
 - default filename
 - default filename when reading from Shapefiles
 - selecting data dictionary
 - selecting data dictionary (tutorial)
- New File screen
- New update status
- NMEA messages
- No GPS message
- Not Transferred file status
- notes in Operation Guide
- number of satellites for carrier phase data
- numeric attributes, adding to data dictionary
- numeric keyboard



O

- obstructions blocking satellite signals
- office computer
 - connecting to CE device
 - connecting to PC running TerraSync
- offsets
 - adding to features
 - bearing-bearing
 - distance-bearing
 - distance-distance
 - for line and area features
 - overview
 - recording with laser rangefinder
 - triple bearing
 - triple distance
- Old navigation message
- Old position message
- OmniSTAR ID
- online help, accessing
- on-screen keyboards
- Open GIS protocol
- opening existing file
 - overview
 - tutorial
- option lists
 - attribute entry form
 - Collect Features screen
 - File Manager screen
 - Map section
 - Navigation section
 - Setup section
 - Update Features screen
- options for logging GPS data
- Options menu buttons
- orange text in Operation Guide
- orbit trails, displaying in Plan section



P

P/PC, definition
 palm-size PC
 accessing help
 definition
 Pan tool in Map section
 panning
 parity, definition
 partnership
 definition
 setting up
 password for configuration file
 passwords, troubleshooting
 Pause button
 Data section
 Map section

pause icon
 overview
 ToolTip
 pausing logging
 in the Data section
 in the Map section
 overview
 tutorial
 PC
 connecting to desktop computer
 requirements
 See also field computer
 PDOP
 definition
 setting maximum value
 PDOP graph
 PDOP information field
 in Satellite Information screen
 in Skyplot screen

[More...](#)



Plan screen
 animated skyplot
 DOP graph
 message line
 overview
 planning a data collection session
 planning skyplot
 Pocket PC
 accessing help
 definition
 point features
 bearing-bearing offsets
 collecting while recording line or area features
 distance-bearing offsets
 distance-distance offsets
 offsets
 triple bearing offsets
 triple distance offsets
 Point offset type form
 point symbol
 Poor satellite geometry message
 pop-up messages
 portrait orientation
 Position Dilution of Precision, definition
 position information
 position, updating
 positions
 accuracy
 logging later
 postprocessing
 definition
 overview
 power output from GPS receiver
 precision level, setting
 precision mode
 Slider
 predicting satellite geometry
 preparing
 for data collection
 for data update

[More...](#)



primary pane
 PRN, definition
 problems

- using the TerraSync software with CE device
- with communications
- with GPS
- with position accuracy
- with real-time corrections

 program memory, changing allocation

- on CE device
- on GeoExplorer CE handheld
- on TSCe

 project, creating using GPS Pathfinder Office
 proximity alarm
 pseudorandom number

- definition
- of satellite

Q

QA/QC data, logging
 questions



R

radio, troubleshooting
 RAM
 RAM backup of TSCe
 rangefinder. *See* laser rangefinder
 raster graphics

- as background files
- definition

 Read dictionary from data form
 Read from Shape form
 reading from Shapefiles
 real-time

- checking status
- settings
- status

 real-time age limit

real-time beacon icon

- overview
- ToolTip

 real-time BoB icon

- overview
- ToolTip

 real-time differential correction

- definition
- sources
- troubleshooting

 real-time differential correction sources

- Beacon-on-a-Belt receiver
- external
- integrated beacon
- integrated satellite
- integrated WAAS
- valid combinations

 real-time icons

- beacon
- BoB



- external satellite WAAS
- real-time satellite icon
 - overview
 - ToolTip
- Real-time Settings form
- Real-time Summary screen
- real-time WAAS icon
 - overview
 - ToolTip
- recalibrating GeoExplorer CE touch screen
- Receive via E-mail form
- receiver
 - power output
 - setup
 - status
 - troubleshooting
- Receiver screen
- receiving files by e-mail

- recording area/line/point features together
- recording between feature positions
- red text in Operation Guide
- refreshing map display
- release notice
- reloading configuration file
- renaming files
- repairing corrupted files
- repeating features
- requirements
 - CE device
 - PC
 - Windows CE
- resetting
 - GeoExplorer CE handheld
 - TerraSync to factory defaults
 - TSCe field device
- Resume button
 - Data section
 - Map section

More...



- resuming logging
 - from the Data section
 - from the Map section
 - tutorial
- rover, definition
- RTCM age limit *See* real-time age limit
- RTCM, definition

S

- satellite
 - bearing to
 - current elevation
 - SNR
- satellite constellation, predicting
- satellite differential service, troubleshooting
- satellite icon
 - flashing
 - number below flashing
 - overview
 - ToolTip
 - using to check the GPS status
- Satellite information screen
 - information fields
 - message line
 - overview
 - use indicator

More...



- satellite signals
 - losing
 - obstructions blocking
- satellites
 - geometry
 - minimum number for carrier phase data
 - positions not being computed
- scale, in Map section
- screen contrast, changing
 - CE device
 - on GeoExplorer CE handheld
 - on TSCe
- screens, overview
- Seaview Authority tutorial
- Seaview data dictionary
- secondary pane
- Section list button
- section structure
- segmenting line features
- Select tool in Map section

- selected feature, automatically panning to
- selected map point, automatically panning to
- selecting
 - background file
 - base files
 - features in Map screen
 - map points
- Send via E-mail form
- sending files by e-mail
- Sensor Mode list button
- Sensor Properties form
- separators, adding to data dictionary
- serial number
 - entering
 - viewing
- Set your navigation target in the Map or Data
 - section message
- setting navigation target
 - in Data section
 - in Map section

More...



- setting precision level
- Setup area
 - in real-time status screens
 - in Satellite information screen
 - in Skyplot screen
- Setup section
 - Beacon-on-a-Belt receiver setup
 - coordinate system
 - external source setup
 - GPS settings
 - integrated beacon setup
 - integrated satellite setup
 - logging settings
 - option list
 - overview
 - real-time
 - real-time Choice fields
 - reference
 - Satellite information table
 - units

- Shapefiles
 - reading from
 - using as background files
 - writing to
- shortcut keys
- showing
 - filtered features (Data section)
 - filtered features (Map section)
 - map layers
 - unfiltered features (Data section)
 - unfiltered features (Map section)
- shp files
- signal-to-noise ratio. *See* SNR
- simple offsets
 - for line and area features
 - for point features
- site, definition
- sky, getting a clear view

More...



- Skyplot graphical screen
 - checking GPS status with information fields
 - message line
 - minimum elevation
 - overview
 - SNR graph
 - ToolTips
 - WAAS icon
- skyplot in Plan screen
- Slider mode
- SNR
 - definition
 - setting minimum value
 - viewing
- SNR graph
- soft reset
 - of GeoExplorer CE handheld
 - of TSCe
- software structure

- sorting
 - features
 - lists
- sound
 - adjusting volume on GeoExplorer CE handheld
 - adjusting volume on TSCe
 - customizing
 - disabling
 - overview
- sources of real-time corrections
- speaker volume, changing
 - on GeoExplorer CE handheld
 - on TSCe
- specifications
 - of CE device
 - of PC
- spikes, reducing effect of

More...



- SSF file format
 - .imp extension
 - conversion from GIS data format
 - conversion into format suitable for GIS systems
 - definition
- Starfish Bay tutorial
- Start moving message
- starting the TerraSync software
- status
 - Beacon-on-a-Belt communications
 - external real-time source
 - filtering by
 - GPS receiver
 - integrated beacon
 - integrated satellite
 - integrated WAAS
 - of communication ports
 - of files

- real-time TerraSync software
- status bar
 - antenna icon
 - battery icon
 - connect icon
 - digitizing icon
 - external real-time icon
 - filter icon
 - icons
 - logging carrier icon
 - logging icon
 - logging vertex icon
 - memory icon
 - overview
 - pause icon
 - real-time beacon icon
 - real-time BoB icon
 - real-time satellite icon
 - real-time WAAS icon

More...



- satellite icon
- ToolTips
- Status Mode list button
- Status section
 - about the TerraSync software
 - BoB real-time status
 - external real-time status
 - integrated beacon real-time status
 - integrated satellite real-time status
 - integrated WAAS real-time status
 - message line
 - mission planning
 - overview
 - real-time status
 - real-time status summary
 - receiver status
 - reference
 - skyplot

- storage card
 - copying files from
 - copying files to
 - in TSCe field device
 - moving files from
 - moving files to
 - selecting background files from
- storage memory, changing allocation
 - on CE device
 - on TSCe
- structure
 - of Data section
 - of Map section
 - of Navigation section
 - of Setup section
 - of Status section
- stylus, calibrating (GeoExplorer CE handheld)
- Subsection list button
- subsections
- SuperCorrect

[More...](#)



- supported
 - CE devices
 - GPS receivers
 - PCs
- symbols, for point features
- synchronization
 - definition
 - overview
 - using to connect to e-mail service
 - using to receive files by e-mail
 - using to send files by e-mail
 - with UTC time
- system report
- system time, incorrect
- system tray
 - backlight icon

T

- target
 - clearing (Data section)
 - clearing (Map section)
 - navigating to
 - opening for update
 - problems with
 - setting (Data section)
 - setting (Map section)
 - setting (tutorial)
- target icon
 - in Close-up screen
 - in Map section
- Target information field
- target-centered close-up style

[More...](#)



- task-switching
 - on CE device
 - on GeoExplorer CE handheld
 - on TSCe
- tcf files, deleting
- TerraSync online Help
- TerraSync Operation Guide
 - navigating
 - online
- TerraSync Professional edition software
- TerraSync software
 - accessing online help
 - color
 - data entry
 - display
 - exiting
 - installing translations on CE device
 - installing translations on PC
 - licensing
 - overview

- Professional edition
- resetting to factory defaults
- screens and controls
- section overview
- sound
- Standard edition
- starting
- status
- troubleshooting
- using
 - See also* TerraSync Standard edition software
- TerraSync Standard edition software
 - overview
 - troubleshooting
- TerraSync Tutorial project
 - creating
 - opening
- text attributes, adding to data dictionary
- text fields
- three-dimensional GPS position

More...



- time
 - calibrating digital camera
 - incorrect
- time attributes
 - adding to data dictionary
 - incorrect
- time fields
- tips in Operation Guide
- tooggling backlight
- tools
 - Digitize
 - Map section
 - Pan
 - Select
 - Zoom In
 - Zoom Out
- ToolTips
 - in Skyplot
 - in status bar
 - transient messages

- touch screen, calibrating
- trademarks
- trajectories, displaying in Plan section
- transfer, problems with
- Transferred file status
- transferring
 - coordinate system export file
 - coordinate system files
 - data dictionary from GPS Pathfinder Office to TerraSync
 - files from the field computer
- transient messages
- translations
 - installing on CE device
 - installing on PC
- Trimble numeric keyboard
- triple bearing offsets
 - creating
 - overview

More...



triple distance offsets

- creating
- overview

troubleshooting

- communications problems
- configuration files
- field computer problems
- GPS problems
- position accuracy
- real-time corrections
- TerraSync software

true north, definition

TSCe field device

- adjusting volume
- connecting to ActiveSync
- installing software
- licensing TerraSync software
- overview
- RAM backup
- resetting

storage card

- switching between applications
- using
- using the keyboard

TSIP messages

Turn information field

tutorial

- data collection
- data update
- preparing for data collection
- preparing for data update
- processing the data
- scenario

type of DOP



U

unable to update features

uncorrected GPS positions

undeleting features

underlined letters in menus

Undo button

undoing digitized positions

Unfiltered Features map layer

unfiltered features, showing or hiding in Data section

unfiltered group

unique names, for features

units

Units form

unlocked

- configuration file
- menu item
- option

unlocking configurations

Update Features screen

- missing features
- overview
- update status

update status

- filtering by
- filtering by (tutorial)
- Imported
- marking feature as updated
- marking feature as updated (tutorial)
- New
- overview
- Updated

Updated update status

updating

- attributes
- attributes from the Map section
- existing data
- GPS position



URL

- in Operation Guide
- of Web map server
- use indicator, in Satellite information table
- using the TerraSync Operation Guide
- using the TerraSync software
 - overview
 - problems with

USNG coordinate system

- entering coordinates in
- using

UTC

- definition
- synchronizing with

UTC Time screen

utilities

- Batch Processor
- Connection Manager
- Coordinate System Manager
- Data Transfer
- Export
- Import
- UTM, definition



V

- valid combinations of real-time correction sources
- values, entering for attributes
- vector graphics
 - as background files
 - definition
- velocity filtering
- velocity, definition
- vertex
 - definition
 - overview
 - recording
- Vertex form
- vertex icon. *See* logging vertex icon

viewing

- attributes of a feature in the Map window
- data files in GPS Pathfinder Office
- features on the map
- GIS data
- Skyplot screen
- virtual keyboards
- volume, changing
 - on GeoExplorer CE handheld
 - on TSCe



W

WAAS

definition

See also integrated WAAS

WAAS satellite icon in skyplot

warning messages

warnings in Operation Guide

waypoint, definition

Web map server

definition

downloading background files from

Web pages in Operation Guide

Web, downloading files from

WGS-84, definition

Windows CE

changing memory allocation

changing screen contrast

requirements

switching between applications

troubleshooting

using

World files

Write to Shape form

writing to Shapefiles



Z

zone, changing

zoom extents

Zoom In tool in Map section

Zoom Out tool in Map section

zooming, in Map screen



Legal information

Copyright

© 2000–2002 Trimble Navigation Limited. All rights reserved.

For STL support, the TerraSync software uses the Moscow Center for SPARC Technology adaptation of the SGI Standard Template Library. Copyright © 1994 Hewlett-Packard Company, Copyright © 1996, 97 Silicon Graphics Computer Systems, Inc., Copyright © 1997 Moscow Center for SPARC Technology.

Portions of this computer program are copyright © 1995-1999 LizardTech, Inc. All rights reserved. MrSID is protected by U.S. Patent No. 5,710,835. Foreign Patents Pending.

Release Notice

This is the July 2002 release (Revision A) of the TerraSync Operation Guide. It applies to version 2.20 of the TerraSync software.

Trademarks

The Globe & Triangle logo, Trimble, BoB, GeoXM, GeoXT, TerraSync, Trimble Survey Controller, and TSCe are trademarks of Trimble Navigation Limited. The Sextant logo with Trimble, GeoExplorer, and GPS Pathfinder are trademarks of Trimble Navigation Limited, registered in the United States Patent and Trademark Office.

MediaMapper is a trademark of Red Hen Systems, Inc. and is used under license.

All other trademarks are the property of their respective owners.



