

MS Series

Operation Manual

Part Number: 40868-00

Revision: A

Date: January 2000

*Trimble Navigation Limited
Surveying & Mapping Division
645 North Mary Avenue
Post Office Box 3642
Sunnyvale, CA 94088-3642
U.S.A.*

+1-800-827-8000 in North America

+1-408-481-8000 International

FAX: +1-408-481-7744

www.trimble.com

*Trimble Navigation Europe Limited
Trimble House, Meridian Office Park
Osborn Way, Hook
Hampshire RG27 9HX
ENGLAND
+44-1256-760-150
FAX: +44-1256-760-148*

*Trimble Navigation Singapore PTE Limited
300 Beach Road
#34-05, The Concourse
Singapore 199555
SINGAPORE
+65-296-2700
FAX: +65-296-8033*

*Trimble Japan K.K.
Sumitomo Hamamatsu-cho, Building 10F
1-18-16 Hamamatsu-cho Minato-ku
Tokyo 105
JAPAN
+81-3-5472-0880
FAX: +81-3-5472-2326*

*Trimble Navigation New Zealand Limited
11 Birmingham Drive
P.O. Box 8729 Riccarton
Christchurch
NEW ZEALAND
+64-3-339-1400
FAX: +64-3-339-1417*

Copyrights

© 2000 Trimble Navigation Limited. All rights reserved. No part of this manual may be copied, photocopied, reproduced, translated, or reduced to any electronic medium or machine-readable form without prior written consent from Trimble Navigation Limited.

Printed in the United States of America. Printed on recycled paper.

Revision Notice

This is the first release of this manual, MS Series Operation Manual, Part Number 40868-00, Revision A, January 2000. This manual describes receiver firmware version 1.05.

Trademarks

MS750, MS860, BD750, BD860, 7400DSi, 7400RSi, 7400MSi, 4000MSK, 4000MSK DGPS Reference Station, 4000RS, 4000RSR, 4000SSi, 4700, 4800, TSC1, Asset Surveyor, Geodetic System Surveyor SSi, DSM, ProBeacon, Site Surveyor SSE, Site Surveyor SSi, Super-trak, Survey Controller, TRIMMARK, TRIMMAP, TRIMNET Plus, TRIMTALK 450, TSIP, TAIP, and WAVE are trademarks of Trimble Navigation Limited. All other brand names are trademarks of their respective holders.

Patents

The MS Series receivers are covered by the following U.S. patents: 4754465, 4847862, 5148179, 5202694, 5296861, 5357527, 5359332, and other patents pending.

Disclaimer of Warranty

EXCEPT AS INDICATED IN “LIMITED WARRANTY” HEREIN, TRIMBLE HARDWARE, SOFTWARE, FIRMWARE AND DOCUMENTATION IS PROVIDED “AS IS” AND WITHOUT EXPRESS OR LIMITED WARRANTY OF ANY KIND BY EITHER TRIMBLE NAVIGATION LIMITED OR ANYONE WHO HAS BEEN INVOLVED IN ITS CREATION, PRODUCTION, OR DISTRIBUTION INCLUDING BUT NOT LIMITED TO THE IMPLIED WARRANTIES OF MERCHANTABILITY AND FITNESS FOR A PARTICULAR PURPOSE. THE ENTIRE RISK, AS TO THE QUALITY AND PERFORMANCE OF THE TRIMBLE HARDWARE, SOFTWARE, FIRMWARE AND DOCUMENTATION, IS WITH YOU. SOME STATES DO NOT ALLOW THE EXCLUSION OF IMPLIED WARRANTIES, SO THE ABOVE EXCLUSION MAY NOT APPLY TO YOU.

Limitation of Liability

IN NO EVENT WILL TRIMBLE NAVIGATION LIMITED OR ANY PERSON INVOLVED IN THE CREATION, PRODUCTION, OR DISTRIBUTION OF THE TRIMBLE SOFTWARE BE LIABLE TO YOU ON ACCOUNT OF ANY CLAIM FOR ANY DAMAGES, INCLUDING ANY LOST PROFITS, LOST SAVINGS, OR OTHER SPECIAL, INCIDENTAL, CONSEQUENTIAL, OR EXEMPLARY DAMAGES, INCLUDING BUT NOT LIMITED TO ANY DAMAGES ASSESSED AGAINST OR PAID BY YOU TO ANY THIRD PARTY, ARISING OUT OF THE USE, LIABILITY TO USE, QUALITY OR PERFORMANCE OF SUCH TRIMBLE SOFTWARE AND DOCUMENTATION, EVEN IF TRIMBLE NAVIGATION LIMITED OR ANY SUCH PERSON OR ENTITY HAS BEEN ADVISED OF THE POSSIBILITY OF DAMAGES, OR FOR ANY CLAIM BY ANY OTHER PARTY. SOME STATES DO NOT ALLOW THE LIMITATION OR EXCLUSION OF LIABILITY FOR INCIDENTAL OR CONSEQUENTIAL DAMAGES SO, THE ABOVE LIMITATIONS MAY NOT APPLY TO YOU.

Software and Firmware Limited Warranty

Trimble warrants that Software and Firmware products will substantially conform to the published specifications provided it is used with the Trimble products, computer products, and operating system for which it was designed. For a period of ninety (90) days, commencing thirty (30) days after shipment from Trimble, Trimble also warrants that the magnetic media on which Software and Firmware are distributed and the documentation are free from defects in materials and workmanship. During the ninety (90) day warranty period, Trimble will replace defective media or documentation, or correct substantial program errors at no charge. If Trimble is unable to replace defective media or documentation, or correct program errors, Trimble will refund the price paid for The Software. These are your sole remedies for any breach in warranty.

Hardware Limited Warranty

Trimble Navigation Limited products are warranted against defects in material and workmanship for a period of one year. The warranty period shall commence thirty (30) days after shipment from Trimble's factory. Warranty service will be provided at a designated Trimble Service Center. Trimble will at its option either repair or replace products that prove to be defective. The Customer shall pay all shipping charges for products returned to Trimble for warranty service. Trimble shall pay all shipping charges for the return of products to the Customer. The above warranty shall not apply to defects resulting from:

1. Improper or inadequate maintenance by the buyer
2. Buyer-supplied software or interfacing
3. Unauthorized modification or misuse
4. Operation outside of the environmental specifications of the product
5. Improper installation, where applicable
6. Lightning or other electrical discharge
7. Fresh or salt water immersion or spray
8. Normal wear and tear on consumable parts (for example, batteries)

No other warranty is expressed or implied. Trimble Navigation Limited specifically disclaims the implied warranties of fitness for a particular purpose and merchantability.

Contents

About This Manual

Scope and Audiencexxi
Organizationxxi
Related Informationxxiii
• Update Notesxxiii
• Other Informationxxiv
World Wide Web (WWW) Sitexxiv
File Transfer Protocol (FTP) Sitexxiv
Technical Assistance.xxiv
Reader Comment Form.xxiv
Document Conventions.xxv
Notes, Tips, Cautions, and Warningsxxv

1 Overview

1.1 Features1-2
1.2 Use and Care1-3
1.3 COCOM Limits.1-3
1.4 Real-Time Kinematic Positioning1-4
1.4.1 What is RTK?1-4
1.4.2 Carrier Phase Initialization1-5
1.4.3 Update Rate and Latency1-7
1.4.4 Data link1-9
1.4.5 RTK Positioning Modes1-11

	Synchronized RTK (1 Hz)1-11
	Fast Update Synchronized RTK (5 or 10 Hz)1-12
	Low Latency RTK.1-13
	Moving Baseline RTK.1-16
	Enhancing Moving Baseline RTK.1-17
	Summary of RTK Positioning Modes1-19
1.4.6	Critical Factors Affecting RTK Accuracy1-20
	Reference Station Receiver Type1-20
	Reference Station Coordinate Accuracy.1-21
	Number of Visible Satellites1-22
	Elevation Mask1-22
	Environmental Factors.1-23
	Operating Range.1-24
1.4.7	Further Reading1-24
1.5	MS Series System Options and Accessories1-25
1.5.1	Rugged L1/L2 Machine Antenna (P/N 38159-00)1-25
1.5.2	Micro-Centered Antenna (P/N 38326-00).1-25
1.5.3	Removable Groundplane (P/N 23158)1-25
1.5.4	TSC1 for MS750 (P/N 300000-90)1-25
1.5.5	TSC1 Download with OSM (P/N 39297-00)1-26
1.5.6	TSC1 Download without OSM (P/N 39297-10)1-26
1.5.7	Type N-to-N, 5-meter Antenna Cable (P/N 17515-01)1-26
1.5.8	Type N-to-N, 15-meter (50 ft.) Antenna Cable (P/N 17515-02)1-26
1.5.9	Type N-to-N, 10-meter Antenna Cable (P/N xxxxx)1-26
1.5.10	Type N-to-N, Rugged 7.5-meter Antenna Cable (P/N 33980-25)1-26
1.5.11	Type N-to-N, Rugged 30-meter Antenna Cable (P/N 33980-99)1-27
1.5.12	BD750 N-to-SMA Antenna Cable (P/N 14563-10)1-27
1.5.13	Data Extension Cable, 3.6 meter (P/N 30700)1-27

1.5.14	MS750 AC Power Supply (P/N 38497-00)	1-27
1.5.15	MS750 Extended Hardware Warranty, I Year (P/N 38312-11)	1-27
1.5.16	MS750 Firmware Update Service, I Year (P/N 38313-11)	1-27

2 Receiver Operation Using the Simulated Keypad and Display

2.1	Remote Controller Software	2-2
2.1.1	POWER Key	2-2
2.1.2	Simulated LCD Display	2-3
2.1.3	Cursor Keys	2-4
2.1.4	Softkeys	2-5
2.1.5	Simulated Keypad	2-6
2.1.6	Function Keys	2-7
2.2	Working with Screens and Fields.	2-8
2.2.1	Types of Fields.	2-8
2.2.2	Display-Only Fields	2-9
2.2.3	Data-Entry Fields	2-9
2.2.4	Carousels	2-9
2.2.5	Entering Data in Fields	2-10
2.3	Receiver Operation	2-10
2.3.1	Receiver Screens.	2-10
2.3.2	POSITION Screen.	2-16
2.3.3	VELOCITY Screen	2-18
2.3.4	ATTITUDE Screen	2-19
2.3.5	VECTOR Screen	2-21
2.3.6	Error Messages	2-24
2.3.7	VECTOR AMBIGUITY STATUS Screen	2-25
2.3.8	VECTOR BASE STATION STATUS Screen	2-27

2.3.9	FACTORY CONFIGURATION Screen2-29
2.3.10	RECEIVER SYSTEMS Screen2-30
2.3.11	COORDINATE REFERENCE Screen2-32
2.3.12	SV TRACKING Screen2-33
2.3.13	SV STATUS Screen2-35
2.3.14	APPLICATION FILE SESSIONS Screen.2-36
2.3.15	STORE CURRENT Screen2-38
2.3.16	CLEAR ALL Screen2-38
2.3.17	BASE STATION Screen.2-39
2.3.18	Base Station Averaging2-41
2.3.19	SV ENABLE/DISABLE Screen.2-43
2.3.20	GENERAL CONTROLS Screen2-44
2.3.21	1 PPS OUTPUT Screen2-46
2.3.22	NMEA/ASCII OUTPUT Screen2-47
2.4	STREAMED OUTPUT Screen2-49
2.4.1	RT17/BINARY OUTPUT Screen2-51
2.4.2	CMR/RTCM OUTPUT Screen2-53
2.4.3	SERIAL PORT SETUP Screen2-55
2.5	INPUT SETUP Screen2-56
2.6	JX-1100 SETUP Screen (Requires Clarion Radio/Modem)	2-57

3 NMEA-0183 Output

3.1	NMEA-0183 Outputs.	3-1
3.2	Common Message Elements	3-3
3.2.1	Message Values	3-3
	Latitude and Longitude	3-3
	Direction.	3-3
	Time	3-4
3.3	NMEA Messages	3-4

4 RS-232 Serial Interface Specification

4.1	Communications Format	4-2
4.1.1	Testing the Communications Link.	4-2
4.1.2	Communication Errors	4-2
4.2	Data Collector Format Packets	4-3
4.2.1	Data Collector Format Packet Structure	4-4
4.2.2	Data Collector Format Packet Functions	4-5
4.2.3	The Receiver STATUS Byte	4-6
4.3	Reading Binary Values	4-7
4.3.1	INTEGER Data Types	4-7
	FLOATING-POINT Data Types	4-8
	FLOAT Data Type.	4-9
	DOUBLE	4-10
4.4	Data Collector Format Packet Summary	4-11
4.5	Application Files	4-13
4.5.1	Application File Records	4-14
4.5.2	Application File Record Format	4-15

5 Data Collector Format Command Packets

5.1	Command Packet Summary	5-2
	Packet Paging	5-11

6 Data Collector Format Report Packets

6.1	Report Packet Summary	6-2
	SV FLAGS Report	6-34
	EPHEMERIS Report	6-36
	ALMANAC Report	6-39
	RETSVDATA UTC/ION Report	6-41
	Packet Paging and Measurement Counting	6-44
	Determining the LENGTH Byte of Records	6-44

Expanded Record Format6-45
Concise Record Format6-49
Position Record (Record Type 11)6-56
Sending a Break Sequence6-64
Identity Message Format6-66
PRODUCT6-66
PORT6-67
VERSION6-68
COMM6-69

7 MS750 Operation

7.1	Installing the MS750 Receiver7-2
7.1.1	Unpacking and Inspecting the Shipment7-2
	Opening the Shipping Carton7-2
	Reporting Shipping Problems7-3
7.1.2	Installation Guidelines7-4
	Choosing a Location7-4
	Considering Environmental Conditions7-4
7.1.3	Mounting the Receiver7-5
7.1.4	Grounding the Receiver7-5
7.1.5	Mounting the Antenna7-6
	Sources of Electrical Interference7-6
7.1.6	MS750 Connections7-7
7.1.7	Routing and Connecting the Antenna Cable7-7
7.1.8	Connecting Power and External Devices7-9
	Connecting the Data/Power Cable7-10
	Connecting the Data/PPS Cable7-11
7.1.9	Completing the Installation7-12
7.2	Getting Started7-13
7.2.1	Using the Front Panel7-13

	Viewing Status Screens	7-16
7.2.2	The Home Screen	7-17
	AppFile	7-18
7.2.3	Contrast	7-19
7.2.4	GPS Status Screens	7-20
	Location	7-20
	Height	7-21
	Velocity	7-22
	GPS Satellite Information	7-23
	DOPs.	7-24
7.2.5	DGPS Status Screens	7-25
	DGPS Info	7-25
7.2.6	RTK Status Screens	7-26
	Horizontal Vector Information	7-26
	Vertical and Length Vector Information	7-27
	RMS and PROP Information	7-28
	Counter and Messages.	7-29
7.2.7	Receiver Status	7-31
	Time Screen	7-31
	Date and GPS Week.	7-32
	Receiver Serial Number	7-33
	Firmware Version and Release Date	7-34
	Receiver Options	7-35
7.3	Configuring the MS750 Receiver	7-36
7.3.1	Using the Keypad to Change Configuration Settings	7-39
7.3.2	GPS Configuration.	7-39
	System Masks	7-40
	RTK Operation	7-41
	Motion State	7-42
	Antenna Type	7-43

Contents

	Application File	7-44
7.3.3	Port Configuration	7-45
	Setting Port Configuration Parameters	7-46
	NMEA Configuration	7-48
	GSOF Configuration	7-50
7.3.4	Base Station Configuration	7-52
	Base Location	7-55
	Set From Here	7-56
	Edit	7-57
	Configure Base Type	7-58
	Configure CMR Out.	7-59
	RTCM Output	7-62
7.4	Moving Base RTK Operation.	7-64
7.4.1	Wireless Method	7-64
7.4.2	Cabled Method	7-65
7.5	MS750 Specifications	7-66
7.6	MS750 Cables and Connectors.	7-68
7.6.1	Port A and Port B Connectors	7-68
	Port A Connector Pin-out Diagram	7-69
	Port B Connector Pin-out Diagram	7-70
7.6.2	Data/Power Cable	7-71
7.6.3	Data/PPS Cable	7-72
7.6.4	Data Extension Cable	7-73
7.7	GPS Antennas and Cables	7-74
7.8	1 PPS Time Strobe and Time Tag	7-75
7.8.1	Using the MS750 with a TSC1	7-77

8 BD750 Operation

8.1	Getting Started	8-2
8.1.1	Unpacking and Inspecting the Shipment	8-2
	Opening the Shipping Carton	8-2
8.1.2	Reporting Shipping Problems	8-3
8.2	Receiver Installation Guidelines	8-4
8.3	Antenna Mounting Guidelines	8-6
8.3.1	Sources of Electrical Interference	8-6
8.4	BD750 Connections	8-7
8.4.1	Routing and Connecting the Antenna Cable	8-8
8.5	Configuring the BD750.	8-9
8.5.1	Communicating With the Receiver	8-9
8.5.2	Static Base Station Configuration	8-10
8.5.3	Configuring the BD750 as a Rover	8-11
8.6	BD750 Specifications	8-12

9 MS860 Receiver Operation

9.1	Receiver Architecture.	9-3
9.2	Installing the MS860 Receiver	9-4
9.2.1	Unpacking and Inspecting the Shipment	9-4
	Opening the Shipping Carton	9-4
	Reporting Shipping Problems	9-5
9.2.2	Installation Guidelines.	9-6
	Choosing a Location.	9-6
	Considering Environmental Conditions.	9-7
9.2.3	Mounting the Antennas	9-8
9.2.4	Routing and Connecting the Antenna Cables	9-9
9.2.5	Connecting Power and External Devices	9-10
	39839-06 Power/Data Cable.	9-10
	39397-06 Data Cable	9-10

Contents

9.2.6	Completing the Installation9-11
9.3	Configuring the MS8609-12
9.3.1	Communicating With the Receiver9-12
9.3.2	Configuring the MS860 as a Rover9-13
9.3.3	Configuring the MS860 to Compute Attitude9-14
9.4	MS860 Specifications9-15
9.5	MS860 Cables and Connectors9-17
9.5.1	I/O 1 and I/O 2 Connectors9-17
9.5.2	Data/Power Cable9-19
9.5.3	Data Cable9-20
9.5.4	MS860 Receiver Dimensions9-21

A Updating Firmware

B Serial Number Form

C Configuration Toolbox Software

C.1	System RequirementsC-2
C.2	Installation ProcedureC-3
C.3	Using Configuration Toolbox SoftwareC-6
C.3.1	Configuring the MS Series ReceiverC-6
C.3.2	Transmitting the Application FileC-8

D Hexadecimal Conversion Table

Bibliography

Glossary

Index

List of Figures

Figure 1-1	Factors Contributing to RTK Latency	1-7
Figure 1-2	Fast Update Rate Synchronized RTK (5 Hz)	1-12
Figure 1-3	Phase Projection for the Low Latency RTK Solution	1-14
Figure 1-4	Moving Baseline RTK Applied to Ship Heading Estimation.	1-16
Figure 2-1	Simulated MS Series Front Panel	2-2
Figure 7-1	MS750 Receiver	7-1
Figure 7-2	Back Panel	7-7
Figure 7-3	Antenna Cable Connections	7-8
Figure 7-4	One Possible Cable Connection Scheme	7-9
Figure 7-5	MS750 Receiver Front Panel	7-13
Figure 7-6	MS750 Status Screen Hierarchy.	7-14
Figure 7-7	GPS Status	7-17
Figure 7-8	Location	7-20
Figure 7-9	Height	7-21
Figure 7-10	Velocity	7-22
Figure 7-11	GPS Satellite Information	7-23
Figure 7-12	DOPs	7-24
Figure 7-13	DGPS Info	7-25
Figure 7-14	Horizontal Vector Status.	7-26
Figure 7-15	Vertical and Length Vector Information	7-27
Figure 7-16	RMS and PROP Information	7-28
Figure 7-17	Counter and Messages	7-29
Figure 7-18	Time	7-31

List of Figures

Figure 7-19	Date and GPS Week	7-32
Figure 7-20	Receiver Serial Number	7-33
Figure 7-21	Firmware Version and Date	7-34
Figure 7-22	Configuration Screen Hierarchy	7-37
Figure 7-23	Serial Port Setup Fields	7-46
Figure 7-24	NMEA Output Fields	7-48
Figure 7-25	GSOE Output Fields	7-50
Figure 7-26	Config Base Station Screen Hierarchy	7-54
Figure 7-27	CMR Output	7-59
Figure 7-28	RTCM Output.	7-62
Figure 7-29	Port A Connector Pin Locations.	7-68
Figure 7-30	Port A Connector Pin-out	7-69
Figure 7-31	Port B Connector Pin-out	7-70
Figure 7-32	Time Tag Relation to 1 PPS Wave Form	7-75
Figure 7-33	MS750 With TSC1 Configuration	7-77
Figure 8-1	BD750 Receiver on Eurocard PC Board	8-1
Figure 8-2	BD750 Edge View	8-4
Figure 8-3	BD750 Dimensioned Outline	8-5
Figure 8-4	Typical BD750 Interconnect	8-7
Figure 9-1	MS860 Receiver	9-2
Figure 9-2	MS860 I/O 1 - 21-pin Connector	9-17
Figure 9-3	MS860 I/O 2 - 8-pin Connector	9-18
Figure 9-4	MS860 Receiver Dimensions	9-21
Figure C-1	Configuration File Window	C-7

List of Tables

Table 1-1	Characterization of RTK Positioning Modes	1-19
Table 1-2	Summary of RTK Functionality Supported by Different RTK Reference Stations	1-20
Table 2-4	Remote Controller Screen Summary	2-11
Table 2-9	RTK Position Fix Errors	2-24
Table 5-1	Command Packet Summary	5-2
Table 5-2	Command Packet 06h Structure	5-3
Table 5-3	Report Packet 08h Structure	5-4
Table 5-4	Command Packet 4Ah Structure	5-5
Table 5-5	Command Packet 54h Structure	5-7
Table 5-7	Command Packet 56h Structure	5-9
Table 5-10	Command Packet 64h Structure	5-12
Table 5-35	Command Packet 65h Structure	5-37
Table 5-36	Command Packet 66h Structure	5-38
Table 5-37	Command Packet 68h Structure	5-39
Table 5-38	Command Packet 6Dh Structure	5-40
Table 5-39	Command Packet 81h Structure	5-41
Table 5-41	Command Packet 82h Structure	5-43
Table 6-1	Report Packet Summary	6-2
Table 6-2	Report Packet 07h Structure	6-4
Table 6-3	Report Packet 09h Structure	6-6
Table 6-4	POSITION FIX Byte Values	6-7
Table 6-5	STATUS OF RECEIVER Byte Values.	6-7
Table 6-6	Report Packet 40h Structure	6-9

List of Tables

Table 6-16	Report Packet 4Bh Structure	6-29
Table 6-25	Report Packet 55h SV FLAGS Report Structure.	6-34
Table 6-26	Report Packet 55h EPHEMERIS Report Structure	6-36
Table 6-27	EPHEMERIS FLAGS	6-38
Table 6-28	Command Packet 55h ALMANAC Report Structure	6-40
Table 6-29	RETSVDATA UTC/ION Packet Structure	6-41
Table 6-30	Report Packet 57h Structure (Expanded Format)	6-45
Table 6-31	Report Packet 57h Structure (Concise Format)	6-49
Table 6-38	Position Record (Record Type 11) Structure.	6-56
Table 6-40	Report Packet 67h Structure	6-61
Table 6-42	Report Packet 6Eh Structure	6-65
Table 6-44	Report Packet 82h Structure	6-70
Table 7-10	Positioning Specifications	7-66
Table 7-12	Data/Power Cable Pin-out (P/N 30945)	7-71
Table 7-13	Data/PPS Cable Pin-out (P/N 37382)	7-72
Table 7-14	Data Extension Cable Pin-out (P/N 30700)	7-73
Table 9-7	Pinout for Data/Power Cable 39839-06	9-19
Table B-1	Receiver Information	B-1
Table B-2	Antenna Information (Optional)	B-1
Table B-3	Power Source Information (Optional)	B-1
Table B-4	Battery Information (Optional).	B-1

About This Manual

Welcome to the *MS Series Receiver Operation Manual*. This manual describes the MS Series family of receivers and provides guidelines for configuring the receiver for real-time, high-precision applications. The MS Series receiver uses advanced navigation architecture to achieve real-time centimeter accuracies with minimal latencies.

Scope and Audience

Even if you have used other Global Positioning System (GPS) receivers, we recommend that you spend some time reading this manual to learn about the special features of your MS Series receiver. The following sections provide you with a guide to this manual, as well as other documentation you have received with this product.

Organization

This manual contains the following chapters and appendices:

- Chapter 1, Overview, provides a brief overview of GPS, RTK, and MS Series components.
- Chapter 2, Receiver Operation Using the Simulated Keypad and Display, gives instructions for using the MS Series display and keypad with Remote Controller software.
- Chapter 3, NMEA-0183 Output, describes the basic structure of NMEA-0183 output messages and describes the NMEA output messages supported by the receiver.

- Chapter 4, RS-232 Serial Interface Specification, describes the structure of the RS-232 Serial Interface Specification command packets and report packets, and describes the data format of values included in packets. Also included is detailed information about the Application File Interface and guidelines for managing the application files stored on the receiver.
- Chapter 5, Data Collector Format Command Packets, summarizes the Trimble RS-232 Serial Interface Specification command packets supported by the receiver and provides detailed descriptions of command packet flow and structure.
- Chapter 6, Data Collector Format Report Packets, summarizes the Trimble RS-232 Serial Interface Specification report packets supported by the receiver and provides detailed descriptions of report packet flow and structure.
- Chapter 7, MS750 Operation, contains installation and interfacing instructions for the MS750 receiver, including how to set up and configure.
- Chapter 8, BD750 Operation, provides details about how to install and set up this new PC Board starter kit for user-defined custom applications.
- Chapter 9, MS860 Receiver Operation, provides details about how to install and operate this new system for centimeter level absolute positioning.
- Appendix A, Updating Firmware, gives instructions for installing new versions of the MS Series receiver firmware.
- Appendix B, Serial Number Form, includes form for recording the serial numbers of your Trimble equipment.
- Appendix C, Configuration Toolbox Software, includes instructions for configuring the MS Series receiver using an application file.

- Appendix D, Hexadecimal Conversion Table, includes decimal to hexadecimal conversion tables.
- The Bibliography includes a list of suggested reading material about GPS.
- The Glossary includes definitions of the terms used throughout this manual.

Related Information

This manual assumes that you are familiar with the basic procedures for operating your MS Series receiver. It also assumes that you are familiar with the principles of the Global Positioning System (GPS), and with the terminology used to discuss it. For example, you should understand such terms as space vehicle (SV), Elevation Mask, and Dilution of Precision (DOP).

If you are not familiar with GPS, we suggest that you read the booklets *GPS, A Guide to the Next Utility* (P/N 16778) and *Differential GPS Explained* (P/N 23036) that are available from Trimble Navigation Limited. For a complete citation to this booklet, see the Bibliography.

Before proceeding to the next chapter, review the following sections for information that will assist you in using this product and communicating with Trimble to receive product updates and other important information.

Update Notes

There is a warranty activation sheet with this product. Send it in to automatically receive update notes as they become available. These contain important information about software and hardware changes. Contact your local Trimble Dealer for more information about the support agreement contracts for software and firmware, and an extended warranty program for hardware.

Other Information

The following sources provide other useful information.

World Wide Web (WWW) Site

For an interactive look at Trimble, visit our site on the World Wide Web (<http://www.trimble.com>).

File Transfer Protocol (FTP) Site

Use the Trimble FTP site to send files or to receive files such as software patches, utilities, and answers to Frequently Asked Questions (FAQs). The address is <ftp://ftp.trimble.com>

You can also access the FTP site from the Trimble World Wide Web site (<http://www.trimble.com/support/support.htm>).

Technical Assistance

If you have a problem and cannot find the information you need in the product documentation, *contact your local dealer*.

Write the model and serial number of your instrument in the space provided below. Always quote this information when contacting your local dealer.

Type Number	Serial Number

Reader Comment Form

Thank you for purchasing this product. We would appreciate feedback about the documentation. Use the reader comment form at the back of this manual or, if this is not available, send comments and suggestions to the address in the front. All comments and suggestions become the property of Trimble Navigation Limited.

Document Conventions

Italics identify software menus, menu commands, dialog boxes, and the dialog box fields.

SMALL CAPITALS identify DOS commands, directories, file names, and file name extensions.

Courier is used to represent what you see printed on the screen by the DOS system or program.

Courier Bold represents information that you must type in a software screen or window.

Return or **Ctrl** + **C** identifies a hardware function key or key combination that you must press on a PC.

Helvetica Bold represents a software command button.

Notes, Tips, Cautions, and Warnings

Notes, tips, cautions, and warnings are used to emphasize important information.



Note – Notes give additional significant information about the subject to increase your knowledge, or guide your actions.



Tip – Indicates a shortcut or other time or labor-saving hint that can help you make better use of the receiver.



Caution – Cautions alert you to situations that could cause hardware damage or software error. A caution precedes the text it references.



Warning – Warnings alert you to situations that could cause personal injury or unrecoverable data loss.

1 Overview

The MS Series receivers can be used for a wide range of precise positioning and navigation applications, including construction, mining and agriculture equipment positioning, robotic equipment control, hydrographic surveying, and any other application requiring reliable centimeter-level guidance at a high update rate and low latency.

The MS Series offers centimeter-level accuracy based on RTK/OTF (Real-Time Kinematic/On-the-Fly) solutions and submeter accuracy based on L1 C/A (Coarse/Acquisition) code phase solutions. Automatic initialization and switching between positioning modes allow for the best position solutions possible. Low latency (< 20 ms) and high update rates (up to 20 Hz) give the response time and accuracy required for precise dynamic applications.

Designed for reliable operation in all environments, the MS Series provides a positioning interface to a PC, external processing device, or control system. The receiver can be controlled through a serial port using an application file interface. The application file interface allows you to script the MS Series receiver operation with a single command. Receiver operations are set using the application file interface supplied, by using the 2 line front panel display and keyboard, or through the Windows configuration/control software.

The MS Series can be configured as an autonomous base station (reference station) or rover receiver (mobile receiver). Streamed outputs from the receiver provide detailed information, including the time, position, quality assurance (figure of merit) numbers, and the number of tracked satellites. The receivers also output a one pulse per second strobe signal, allowing remote devices to precisely synchronize time.

1.1 Features

The receivers provide the following available features:

- Centimeter accuracy, real-time positioning with RTK/OTF data, up to 20 Hz position updates and around 20ms latency
- Submeter accuracy, real-time positioning using pseudorange corrections with less than 20ms latency
- Automatic OTF (On-the-Fly) initialization while moving
- Local coordinates output direct from receiver
- 1 PPS output
- Range of packaging for environmental requirements
- One year hardware warranty
- Three RS-232 serial ports:
 - NMEA Output
 - RTCM SC-104 input and output
 - Trimble Format (CMR) input and output
- CAN Interface

1.2 Use and Care

The MS receiver series is designed to withstand the rough treatment typical of equipment used in the field. However, the receiver is a high-precision electronic instrument and should be treated with reasonable care.

High-power signals from a near-by radio or radar transmitter can overwhelm the MS receiver circuits. This does not harm the instrument, but it can prevent the receiver electronics from functioning correctly. Avoid using the receiver within 400 meters of powerful radar, television, or other transmitters. Low-power transmitters such as those used in portable phones and walkie-talkies normally do not interfere with MS Series operations. For more information, see the Trimble technical note *Using Radio Communication Systems with GPS Surveying Receivers*.



Warning – Operating or storing the MS receiver outside the specified temperature range can destroy or limit the longevity of the instrument.

1.3 COCOM Limits

The U.S. Department of Commerce COCOM regulations require all exportable GPS products to contain performance limitations, preventing their use in a manner threatening the security of the United States. In accordance, the MS receiver disables access to satellite measurements and navigation results when the receiver's velocity is greater than 1000 knots, or its altitude is above 18,000 meters. Access is restored when both limits are no longer exceeded.

During the violation period, all displays of position and velocity related quantities are blanked, and all access to those quantities through the serial ports is disabled. All applicable data fields in serial output have zero values. These fields include position and velocity results.

1.4 Real-Time Kinematic Positioning

The MS Series receivers are designed for high-precision navigation and location and uses Real-Time Kinematic (RTK) techniques to achieve centimeter-level positioning accuracy. The following section provides background information on terminology plus the capabilities and limitations of the MS Series. A list of references for learning more about these topics is also provided (see Further Reading, page 1-24).

1.4.1 What is RTK?

Real-Time Kinematic (RTK) positioning is based on at least two GPS receivers—a reference receiver and one or more rover receivers. The reference receiver takes measurements from satellites in view and then broadcasts them, with its location, to the rover receiver(s). The rover receiver also collects measurements to the satellites in view and processes them with the reference station data. The rover then estimates its location relative to the reference. Typically, reference and rover receivers take measurements at regular 1 second epochs (events in time) and produce position solutions at the same rate.

The key to achieving centimeter-level positioning accuracy with RTK is the use of the GPS carrier phase signals. Carrier phase measurements are like precise tape measures from the reference and rover antennas to the satellites. In the MS Series, carrier phase measurements are made with millimeter-precision. Although carrier phase measurements are highly precise, they contain an unknown bias, termed the integer cycle ambiguity, or phase ambiguity. The MS Series rover has to resolve, or initialize, the carrier phase ambiguities at power-up and every time the satellite signals are interrupted.

1.4.2 Carrier Phase Initialization

The MS Series can automatically initialize the carrier phase ambiguities as long as at least 5 common satellites are being tracked at reference and rover sites. *Automatic initialization* is sometimes termed *On-The-Fly (OTF)* or *On-The-Move*, to reflect that no restriction is placed on the motion of the rover receiver throughout the initialization process.

The MS Series uses L1 and L2 carrier measurements plus precise code range measurements to the satellites to automatically initialize the ambiguities. The initialization process takes between 25 seconds to a few minutes. While the receiver is initializing the ambiguities it generates a *float* solution with meter-level accuracy. The float solution is reflected in the position display and outputs. When the initialization process is complete, the solution mode switches from *float* to *fix*, and the precision changes from meter-level to centimeter-level accuracy.

As long as at least 4 common satellites are continuously tracked after a successful initialization, the ambiguity initialization process does not have to be repeated. The MS750 display has a counter for monitoring the continuous number of 1-second epochs occurring since the most recent initialization (see Getting Started, page 7-13 in Chapter 7, MS750 Operation).



Note – Initialization time is determined by baseline length, multipath and prevailing atmospheric errors. Minimize reflective objects close to the antennas and keep baseline lengths and differences in elevation between the reference and rover sites as small as possible.



Warning – Although initialization in the MS receiver is very reliable, incorrect initializations can occur. A bad initialization can result in position errors of 1 to 3 meters. The receiver automatically detects initialization failures, and reports and fixes the problem. Bad initialization detection may take 1 to 4 minutes, depending on the number of satellites being tracked. Generally, a bad initialization is followed by an increasing solution RMS.

1.4.3 Update Rate and Latency

The number of position fixes delivered by an RTK system per second also defines how closely the trajectory of the rover can be represented and the ease with which position navigation can be accomplished. The number of RTK position fixes generated per second defines the *update rate*. Update rate is quoted in Hertz. For the MS receiver, the maximum update rate is 20 Hertz.

Solution latency refers to the lag in time between when the position was valid and when it was displayed. For precise navigation, it is important to have prompt position estimates, not values from 2 seconds ago. Solution latency is particularly important when guiding a moving vehicle. For example, a vehicle traveling at 25 kilometers/hour, moves approximately 7 meters per second. Thus, to navigate to within 1 meter, the solution latency must be less than $1/7$ ($= 0.14$) seconds.

Figure 1-1 contains a summary of the factors contributing to the latency in the synchronized RTK solution.

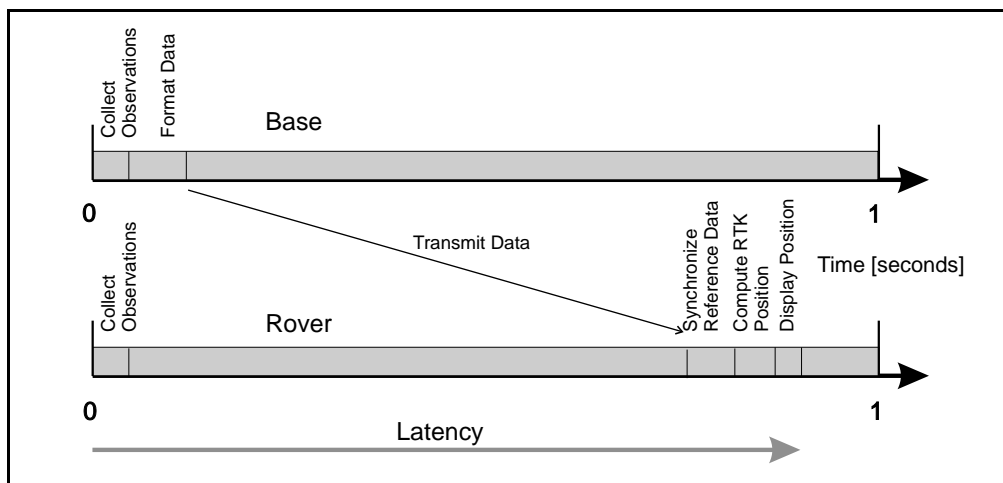

Figure 1-1 Factors Contributing to RTK Latency

The accumulation of the following parameters often amounts to a latency of 0.5 to 2 seconds in the MS750 RTK solution:

- Reference receiver observation collection time
- Reference data formatting
- Data transmission
- Synchronization of reference and rover data
- Position calculation
- Solution display / output

1.4.4 Data link

The reference-to-rover data link serves an essential role in an RTK system. The data link must transfer the reference receiver carrier phase, code measurements, plus the location and description of the reference station, to the rover.

The MS receiver supports two data transmission standards for RTK positioning, the Compact Measurement Record (CMR) format and the RTCM / RTK messages. The Compact Measurement Record (CMR) format was designed by Trimble and is supported across all Trimble RTK products. See Talbot [1996] and Talbot [1997] in Further Reading, page 1-24, for a detailed description of this standard. The Radio Technical Commission for Maritime Services (RTCM) developed RTK messages as part of their Version 2.2 standard. See RTCM [1998] in Further Reading, page 1-24.

RTCM / RTK messages 18 to 21 were aimed at forming an industry standard for mixing and matching RTK reference and rover systems from different manufacturers. Industry acceptance of the RTCM / RTK messages has been limited, because the messages require at least a 4800 baud data link, compared with a 2400 baud data link for the Compact Measurement Record format. Furthermore, antenna and receiver compatibility issues have not been completely resolved between RTK manufacturers. Use caution when trying to mix RTK systems from different manufacturers; degraded performance nearly always results.

Not all RTK positioning modes are supported when the RTCM / RTK format is used. Use the Compact Measurement Record format for all Trimble RTK positioning applications.

TRIMCOMM 900 radio modems are designed for MS Series RTK operation. Similarly, TRIMTALK 450 radio modems are customized for RTK applications. The TRIMCOMM 900 systems do not require licensing in the U.S. and several other countries around the World. Third-party radio modems, cellular phones, or satellite communication links can transmit base station data to one or more rover sites.

Factors to consider when choosing a data link include:

- Throughput capacity
- Range
- Duty cycle
- Error checking / correction
- Power consumption

The data link must support at least 4800 baud, and preferably 9600 baud throughput. Trimble support staff (see Technical Assistance, page -xxi) can assist with questions regarding data link options.

1.4.5 RTK Positioning Modes

The MS Series incorporates four positioning modes to support a broad spectrum of user applications. The following section highlights the differences and requirements for each positioning mode.

Synchronized RTK (1 Hz)

Synchronized RTK is the most widely used technique to achieve centimeter-level position estimates between a fixed reference station and a roving receiver. Typically, the update rate for Synchronized RTK is once per second (1 Hz). With Synchronized RTK, the rover receiver must wait until the reference station measurements are received before computing a baseline vector. The latency of the Synchronized position fixes is dominated by the data link delay (see Figure 1-1). Given a 4800 baud data link, the latency of the Synchronized RTK fixes will approach 0.5 seconds. The solution latency could be reduced by using a 9600 baud, or higher bandwidth data link.

The Synchronized RTK solution yields the highest precision possible and suits low dynamic applications such as human-mounted guidance. Airborne applications such as photogrammetry, or aircraft landing system calibration, demand update rates in excess of 1 Hz, to sample the platform trajectory. Data postprocessing can generate the results of the mission back in the office. However, this would require raw GPS data to be stored and postprocessed. Postprocessing presents data management problems, particularly for large data sets collected at 5 or 10 Hz. The MS Series includes a new positioning mode—termed *Fast Update Synchronized RTK*—which addresses high speed positioning applications.

Fast Update Synchronized RTK (5 or 10 Hz)

The Fast Update Synchronized RTK scheme has the same latency and precision as the 1 Hz Synchronized approach. However, position solutions are generated 5 or 10 times per second (5 or 10 Hz), see Figure 1-2.

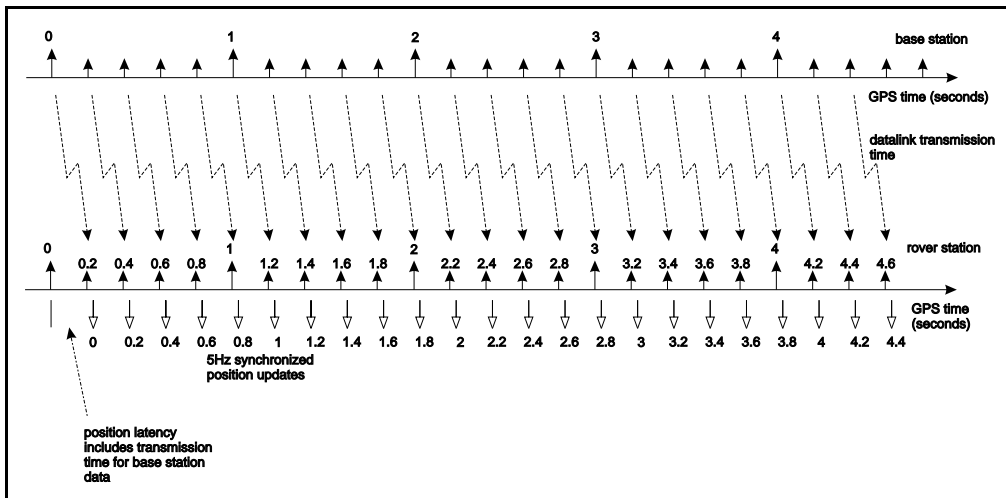

Figure 1-2 Fast Update Rate Synchronized RTK (5 Hz)

The MS Series reference station must be configured to output CMR data in either the 5 Hz or 10 Hz CMR Mode. In the Fast Output Mode, the MS Series reference receiver interleaves the 1 Hz CMR measurement data with highly compressed information at the x.2, x.4, x.6 and x.8 second epochs for 5 Hz output. At the 10 Hz CMR output rate, packets are sent at x.1, x.2, x.3, ..., x.9 seconds between the x.0 epochs. The total data throughput requirement for the Fast Mode is less than 9600 bits for 9 satellites.

The MS rover synchronizes its own 5 or 10 Hz measurements with those received from the reference. Results are then generated and can be output at 5 or 10 Hz. The data link throughput is critical to the operation of the Fast Update Synchronized RTK scheme. Use at least a 9600 baud data link to achieve satisfactory results.



Note – The Fast Update Synchronized RTK mode is only supported through the Compact Measurement Record (CMR) format. The RTCM messages cannot be output at 5 or 10 Hz.

Low Latency RTK

A large part of the solution latency in Synchronized RTK processing is due to the data formatting and transmission of the reference station data to the rover, see Figure 1-1. The MS Series includes a Low Latency positioning mode for applications that demand centimeter-level accuracy almost instantaneously. The Low Latency positioning mode delivers 20 Hz position fixes with around 20 millisecond latency with a precision that is only slightly less accurate than Synchronized RTK positioning.

The Low Latency positioning scheme relies on the predictability of the reference station phase data. Phase measurements observed at a fixed reference receiver generally exhibit a smooth trend. Variations in the carrier phase are caused by:

- Cycle slips
- Satellite motion
- Receiver and satellite clock variations
- Atmospheric delay

Given a brief history of reference station phase measurements, the MS receiver is able to accurately predict what they will be in the next few seconds. Instead of waiting for reference station carrier phase measurements to arrive, the MS rover predicts or projects what the reference carrier phase measurements will be for the current epoch. A baseline solution is then generated using the projected reference station carrier phase measurements and the observed rover receiver carrier phase. The latency of the position solution derived from projected carrier phase is around 20 milliseconds for the MS Series.

With the Low Latency positioning scheme, accuracy is traded for timeliness. An increase in the data link delay relates to an increase in the projection time of the reference station phase data. This leads to an increase in the uncertainty of the RTK solution. Figure 1-3 presents an empirically derived model for the reference receiver phase projection errors as a function of data link delay.

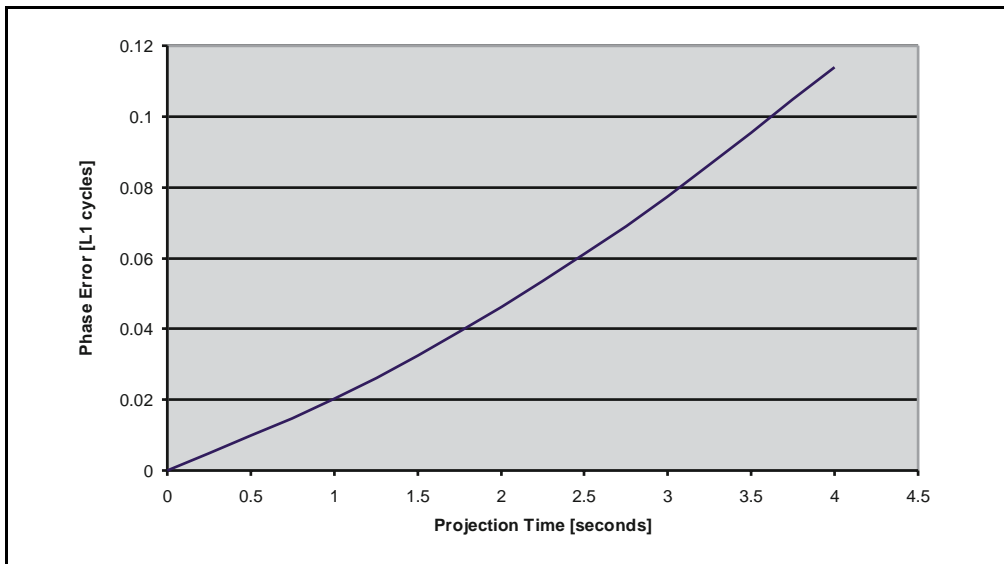

Figure 1-3 Phase Projection for the Low Latency RTK Solution

The reference phase prediction errors are governed by:

- Unmodeled Selective Availability errors
- Short term instabilities in the receiver and satellite clocks
- Unmodeled satellite orbit variations

A data link latency of 1 second would result in phase projection errors approaching 0.02 cycles (0.004 meters). Multiplying the phase projection errors by a PDOP of 3.0 would yield an increase in noise for the Low Latency RTK solution of $3.0 \times 0.004 = 0.012$ meters over the Synchronized RTK solution. In many applications the slight noise increase in the Low Latency Solution is tolerable.

Moving Baseline RTK

In most RTK applications, the reference station remains stationary at a known location, while the rover moves. A new method of RTK positioning, called *Moving Baseline RTK*, is implemented in the MS Series, in which both reference and rover receivers move. The Moving Baseline RTK technique can be used for vehicle orientation applications (see Figure 1-4), and precise relative displacement tracking of two moving vehicles.

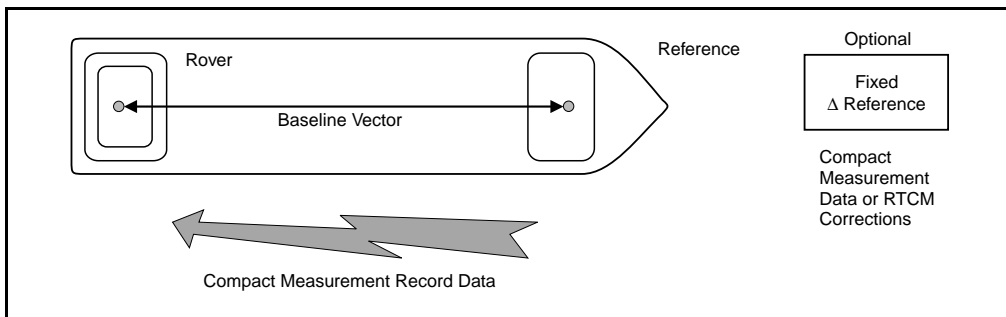

Figure 1-4 Moving Baseline RTK Applied to Ship Heading Estimation

With the Moving Baseline RTK technique, the reference receiver broadcasts CMR measurement and station location data every epoch and the rover receiver performs a synchronized baseline solution at 1 or 5 or 10 Hz. The resultant baseline solution is accurate to centimeter-level, while the absolute location of the reference—rover space vector is only accurate to 100 meters. The accuracy of the derived baseline vector is somewhat dictated by the knowledge of the moving reference location. For this reason, the reference-rover separation should be less than 1 kilometer to ensure optimal results.

See Moving Base RTK Operation, page 7-64 for more information.

Enhancing Moving Baseline RTK

Although the Moving Baseline RTK mode provides centimeter-level vector components between moving reference and rover, the absolute coordinates of the reference and rover are only generally known to 100 meters. The MS Series receiver is capable of performing DGPS or RTK while acting as the moving reference station are estimated relative to a fixed reference to say meter-level with DGPS, or centimeter-level with RTK. This technique is best explained with an example.

In Figure 1-4, a shore-based (fixed) reference station sends either RTCM or CMR data to the moving reference station on a ship.

The moving reference station receives differential corrections from the shore-based reference station and generates position solutions. The moving reference station can be operated in either Low Latency mode or Synchronized mode. CMR data is output by the moving reference station to the rover at either 1, 5 or 10 Hz by using the Standard or Fast CMR output modes, respectively.

The rover accepts CMR data from the moving reference station and generates an RTK vector solution at the same rate as moving reference CMR transmissions. The rover must be configured in the Synchronized mode. The MS Series receiver will automatically force the unit into the Synchronized mode if the Low Latency mode is currently active.

When the roving reference station is differentially corrected, both the vector displacement and absolute location of the moving baseline are derived.

The moving Baseline RTK mode can *chain* together multiple moving reference receivers. Chained-RTK is best explained with an example. Consider a static reference station (receiver 1) sending out CMR data at 10 Hz. A moving MS Series (receiver 2) receives the CMR data from the static reference and estimates its location and then outputs CMR data at a 10 Hz rate. Another moving MS750 receiver (receiver 3) receives the CMR data from receiver 2 and performs a synchronized RTK solution. Receiver 3 then generates CMR data for transmission to yet another MS Series receiver and so on. The solution latency for the last receiver is the summation of the transmission delays of the previous links in the chain. The technique is therefore limited by the data link throughput. The Chained RTK mode can determine the location and orientation of large structures such as bridge elements as they are being moved into position.

Summary of RTK Positioning Modes

Table 1-1 provides a summary of the RTK positioning modes available in the MS Series receiver.

Table 1-1 Characterization of RTK Positioning Modes

RTK Mode	Update Rate (Hz)	Latency (seconds)	Data Link Requirement ² (Baud)	Accuracy ⁵
Synchronized	1	0.5 – 2.5 ¹	2400	horizontal: 1 cm + 2 ppm vertical: 2 cm + 2 ppm
Fast Update Synchronized	5 or 10	0.5- 2.5 ¹	9600	horizontal: 1 cm + 2 ppm vertical: 2 cm + 2 ppm
Low Latency	20 (max)	0.02	2400	horizontal: 2 cm + 2 ppm ³ vertical: 3 cm + 2 ppm
Moving Baseline RTK	1, 5, 10	0.5 – 2.5 ¹	4800, 9600	horizontal: 1 cm ⁴ vertical: 2 cm
<p>1 Latency is dependent on data link throughput.</p> <p>2 Minimum bandwidth requirement – higher bandwidths provide increased performance.</p> <p>3 Accuracy figures assume a 1 second data link delay.</p> <p>4 Assumes that reference – rover separation is less than 1 kilometer.</p> <p>5 Accuracy figures are 1 sigma.</p>				

1.4.6 Critical Factors Affecting RTK Accuracy

The following sections present system limitations and potential problems that could be encountered during RTK operation.

Reference Station Receiver Type

The MS Series uses a state-of-the-art tracking scheme to collect satellite measurements. Optimal RTK performance is achieved when using MS Series receivers at reference and rover sites. The MS Series is compatible with all other Trimble RTK-capable systems, however, not all RTK positioning modes are supported with mixed receiver operation. Table 1-2 lists the compatibility of various Trimble RTK reference stations with the positioning modes of the MS receiver.

Table 1-2 Summary of RTK Functionality Supported by Different RTK Reference Stations

Reference Receiver Type	Synchronized RTK (1 Hz)	Fast Update Synchronized RTK (5 or 10 Hz)	Low Latency RTK	Moving Baseline RTK
MS Series	✓	✓	✓	✓
Series 7400	✓		✓	✓
4800	✓		✓	
4700	✓		✓	
4600LS	✓			
4400	✓		✓	
4000SSi	✓		✓	



Warning – The use of non-Trimble reference receivers with an MS Series rover is not advised. Sub-optimal initialization reliability and RTK performance may result.

Reference Station Coordinate Accuracy

The reference station coordinates used for RTK positioning are set through the *Base Station Control* menu. The reference station coordinates should be known to within 10 meters in the WGS-84 datum for optimal system operation. Incorrect or inaccurate reference station coordinates degrade the rover position solution. It is estimated that every 10 meters of error in the reference station coordinates introduces one part per million error in the baseline vector. This means that if the base station coordinates have a height error of 50 meters, and the baseline vector is 10 kilometers, then the error in the rover location is approximately five centimeters.

The second effect of reference station coordinate errors is on the Low Latency RTK solutions. In the case of Low Latency positioning, the baseline vector errors will ramp up with increased data link age.

For Moving Baseline RTK, the reference station coordinates are only determined with 100 meter accuracy. For this reason, the Moving Baseline RTK works best when reference-to-rover separation is less than 1 kilometer.

Number of Visible Satellites

A GPS position fix can be considered a distance resection. Satellite geometry directly impacts on the quality of the position solution estimated by the MS Series. The Global Positioning System is designed so that at least 5 satellites are above the local horizon at all times. For many times throughout the day, as many as 8 satellites or more might be above the horizon. Because the satellites are orbiting, satellite geometry changes during the day, but repeats from day-to-day. A minimum of 4 satellites are required to estimate user location and time. If more than 4 satellites are tracked, then an overdetermined solution is performed and the solution reliability can be measured. The more satellites, the greater the solution quality and integrity.

The Position Dilution Of Precision (PDOP) provides a measure of the prevailing satellite geometry. Low PDOP values, in the range of 4.0 or less, indicate good satellite geometry, whereas a PDOP greater than 5.0 indicates that satellite geometry is weak.

Even though only 4 satellites are needed to form a three-dimensional position fix, RTK initialization demands that at least 5 common satellites must be tracked at reference and rover sites. Furthermore, L1 and L2 carrier phase data must be tracked on the 5 common satellites for successful RTK initialization.

Elevation Mask

The Elevation Mask stops the MS Series from using satellites that are low on the horizon. Atmospheric errors and signal multipath are largest for low elevation satellites. Rather than attempting to use all satellites in view, the MS Series uses a default Elevation Mask of 13 degrees. System performance is degraded if a lower Elevation Mask is used.

Environmental Factors

Environmental factors impacting GPS measurement quality include:

- Ionospheric activity
- Tropospheric activity
- Signal obstructions
- Multipath
- Radio interference

High ionospheric activity can cause rapid changes in the GPS signal delay, even between receivers a few kilometers apart. Equatorial and polar regions of the Earth are most affected by ionospheric activity around mid-day. The RTK initialization time can increase when ionospheric activity is high.

The region of the atmosphere up to about 50 kilometers is termed the *troposphere*. The troposphere causes a delay in the GPS signals which varies with height above sea level, prevailing weather conditions and satellite elevation angle. The MS Series includes a tropospheric model which attempts to reduce the impact of the tropospheric error. If possible, try to locate the reference station at approximately the same elevation as the rover.

Signal obstructions limit the number of visible satellites and can also induce signal multipath. Flat metallic objects located near the antenna can cause signal reflection before reception at the GPS antenna. For phase measurements and RTK positioning, multipath errors are on the order of 1 to 5 centimeters. Multipath errors tend to average out when the roving antenna is moving, while a static reference station may experience very slowly changing biases. If possible, locate the reference station in a clear environment with an open view of the sky. If possible use an antenna with a ground plane to help minimize multipath.

The MS Series provides good radio interference rejection. However, a radio or radar emission directed at the GPS antenna can cause serious degradation in signal quality or complete loss of signal tracking. Do not locate the reference station in an area where radio transmission interference can become a problem.

Operating Range

Operating range refers to the maximum separation between reference and rover sites. Often the characteristics of the data link determine the RTK operating range. The initialization performance of the MS Series is optimized for an operating range up to 10 kilometers. Degraded initialization time and reliability are likely to result if RTK is attempted beyond the 10 kilometer operating range specification.

1.4.7 Further Reading

RTCM, 1998. RTCM Recommended Standards for Differential GNSS Service, Version 2.2, RTCM Paper 11-98 / SC104-STD, January 15.

Talbot, N.C. 1996. Compact Data Transmission Standard for High-Precision GPS, ION-GPS-96, Kansas City, Missouri, September 17-20, pp.861-871.

Talbot, N.C. 1997. Improvements in the Compact measurement Record Format, Trimble Users Conference, San Jose, California. pp.322-337.

1.5 MS Series System Options and Accessories

The MS Series receivers support options which can be purchased in addition to the standard system.



Note – GPS antenna and cable are not part of the standard system.

1.5.1 Rugged L1/L2 Machine Antenna (P/N 38159-00)

The Rugged L1/L2 Machine Antenna was designed for machine environment installation. It features the high performance patented Micro-centered element and electronics in a rugged aluminum housing with four 1/4-20 UNC threaded holes for mounting. The antenna incorporates a permanently attached 13-inch diameter ground plane which significantly reduces multipath both onboard the machine and its associated reference station. The antenna cable is not included.

1.5.2 Micro-Centered Antenna (P/N 38326-00)

The Micro-centered antenna features the high performance patented Micro-centered element and electronics in a lightweight plastic housing with 5/8-11 UNC thread for mounting. The antenna cable and removable ground plane not included.

1.5.3 Removable Groundplane (P/N 23158)

The Removable Groundplane reduces multipath effects on antennas such as the Micro-centered antenna (P/N 38326-00).

1.5.4 TSC1 for MS750 (P/N 300000-90)

This is the Trimble System Controller (TSC1™) data collector, a hand-held unit suitable for field operations. It can be used to run Trimble System Controller software.

1.5.5 TSC1 Download with OSM (P/N 39297-00)

This item includes the TSC1 plus remote controller software (see Chapter 2) and a Support Module for battery re-charging.

1.5.6 TSC1 Download without OSM (P/N 39297-10)

This item is similar to the above, without the Support Module.

1.5.7 Type N-to-N, 5-meter Antenna Cable (P/N 17515-01)

The Type N-to-N, 5-meter (16 ft.) antenna cable is a low loss GPS antenna cable that connects the GPS antenna to MS Series receivers with Type N connectors.

1.5.8 Type N-to-N, 15-meter (50 ft.) Antenna Cable (P/N 17515-02)

The Type N-to-N, 15-meter (50 ft.) antenna cable is a low loss GPS antenna cable that connects the GPS antenna to MS Series receivers with Type N connectors.

1.5.9 Type N-to-N, 10-meter Antenna Cable (P/N xxxxx)

The Type N-to-N, 10-meter (33 ft.) Antenna Cable is a low loss GPS antenna cable that connects the GPS antenna to the MS750 receiver.

1.5.10 Type N-to-N, Rugged 7.5-meter Antenna Cable (P/N 33980-25)

The Rugged Type N-to-N, 7.5-meter (25 ft.) antenna cable is a low loss GPS antenna cable that connects the GPS antenna to MS Series receivers with Type N connectors. This cable is designed for the harsh environments of the mining and construction industry.

1.5.11 Type N-to-N, Rugged 30-meter Antenna Cable (P/N 33980-99)

The Rugged Type N-to-N, 30-meter (98 ft.) antenna cable is a low loss GPS antenna cable that connects the GPS antenna to MS Series receivers with Type N connectors. This cable is designed for the harsh environments of the mining and construction industry.

1.5.12 BD750 N-to-SMA Antenna Cable (P/N 14563-10)

This 5 meter antenna cable connects BD750 to L1/L2 N-type antenna connectors.

1.5.13 Data Extension Cable, 3.6 meter (P/N 30700)

The 3.6-meter (12 ft.) data extension cable extends the distance between the data/power and data/PPS cables (included with the unit) and external serial devices. The cable can extend the length of the serial port A-1 and B-1 connections only and can not extend the length of a serial port B-2 connection.

1.5.14 MS750 AC Power Supply (P/N 38497-00)

The power supply allows the MS Series receiver to be powered from a 100-250 VAC source and provides a serial interface to Port A or B.

1.5.15 MS750 Extended Hardware Warranty, 1 Year (P/N 38312-11)

1.5.16 MS750 Firmware Update Service, 1 Year (P/N 38313-11)

2 Receiver Operation Using the Simulated Keypad and Display

The Remote Controller software supplied with the MS Series receiver serves as a virtual keypad and display screen for the receivers. This chapter gives you the basic skills necessary to use the Remote Controller software's simulated keypad and display.



Note – For the MS750 receiver, configuration and status monitoring may be performed using the integrated display and keypad, see Chapter 7.

To use the Remote Controller software, you need to connect one of the MS Series I/O ports to one of the serial ports on an IBM compatible PC computer. The software runs under Microsoft Windows and manages the communications link between the PC and MS Series receiver. This chapter assumes that the Remote Controller software is installed on a PC, and the PC is connected to a MS Series receiver.

2.1 Remote Controller Software

The Remote Controller software's simulated keypad and display are shown in Figure 2-1.

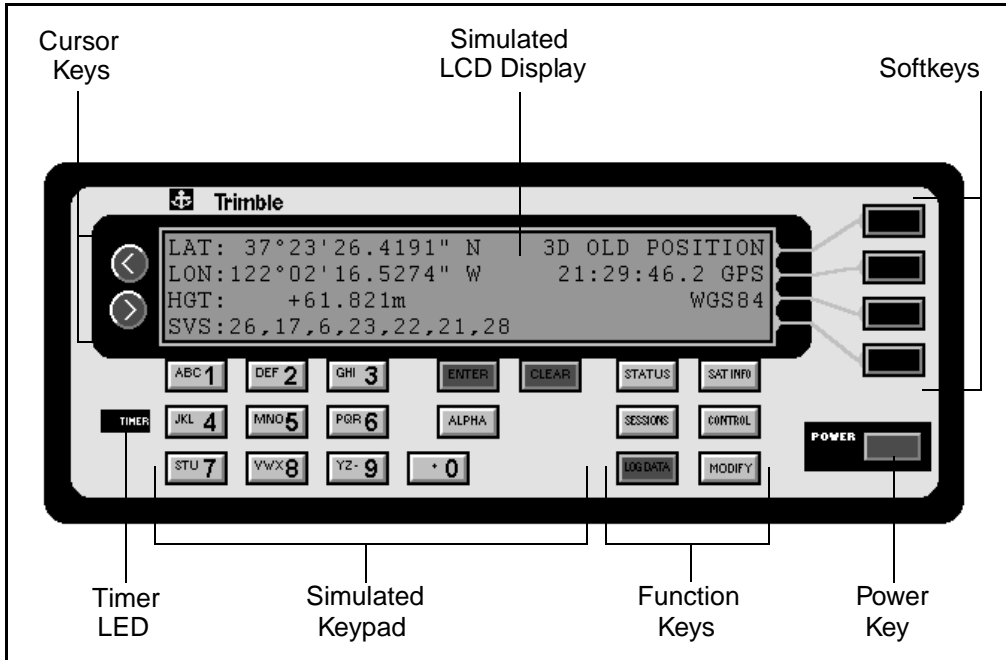

Figure 2-1 Simulated MS Series Front Panel

2.1.1 POWER Key

The **POWER** key is disabled on an MS Series receiver.

2.1.2 Simulated LCD Display

The simulated LCD display displays data about the current position or survey operation, the satellites tracked by the receiver, the internal status of the receiver, and a variety of other information.

The data displayed on the simulated LCD display is called a screen and the various types of data are displayed in fields. Three types of files are displayed on the simulated screens—Display-only fields, Data-entry fields, and Carousels. For detailed information about fields, see *Working with Screens and Fields*, page 2-8.

The simulated LCD display can display four lines of data at once. When more than four lines of data is available for display, a down arrow (↓) appears in the upper left corner of the display. You can press the **[ALPHA]** key to display another four lines of data. The sample screens in this manual show all of the lines of data associated with a screen without displaying the arrow symbol.

Some screens are displayed solely for the purpose of viewing status information. For instance, the *SAT INFO* screens show satellite tracking and status information.

Data-entry screens are displayed when you need to configure the operation of the receiver.

Many status and data-entry fields include menu options for displaying additional screens and these screens can contain menus for displaying more screens. Menu options are displayed on the right side of the screen enclosed within angle brackets.

2.1.3 Cursor Keys

The # and \$ keys let you move the cursor around the screen. You use the cursor keys to move the cursor to data-entry fields before entering data or choosing options from carousel fields. The # and \$ keys are also used to position the cursor within a field when entering numeric or alphanumeric characters. Each time you click on the # or \$ key, the cursor moves in the direction of the arrow label on the key.

The # key move the cursor to the preceding line when the cursor resides in the first character position within a data entry field. The \$ key moves to the next line when the cursor resides in the last character position within a field.

2.1.4 Softkeys

The four softkeys perform different functions, depending on the menu options displayed on the right side of the simulated display. Menu options (also called softkey options) are displayed on the screen enclosed within left and right angle brackets (< >). One softkey is provided for each of the four lines on the simulated LCD display. The first (top) softkey performs the action described by the menu option on the first line of the display, the second softkey performs the action associated with the menu option on the second screen line, and so on. When a menu option is not displayed on a screen for a specific screen line, the associated softkey performs no action.

In the sample screen below, one menu option (the <HERE> softkey) is displayed.

```
BASE STATION (CONTROL)           <HERE>
[CMR]:[OFF  ]    ANT. HT.:00.000 m
LAT: 00000.00000" N NAME: 0000
LON:00000000.00000" E HGT:+0000.000m.
```

The menu action associated with a softkey could be executed immediately, or the action could display another screen which might include additional menu options. In the sample screen above, the <HERE> softkey enters the current position as the coordinates for a base station.

Throughout this manual, softkey options are shown in procedures enclosed within angle brackets and in boldface type.

2.1.5 Simulated Keypad

Use the simulated keypad to enter alphanumeric and numeric data, and to select predefined values for data-entry fields. Table 2-1 describes the operation of the simulated keypad.

Table 2-1 Keypad Functions

Key / Symbol	Description
0 – 9	The numeric keys let you enter numeric data.
A – Z	The alpha keys become active when a field is intended to accept alpha data and the ALPHA key is pressed.
ALPHA	Pages through multiple screen lines, softkey options, or predefined field options.
ENTER	Accepts change entered into data fields. Press ENTER from the last data field to accept all changes entered in all fields.
CLEAR	Returns to the previous screen without saving the changes made in any data fields.

2.1.6 Function Keys

The six function keys display screens with options for displaying status information and additional screens for controlling MS Series functions and options. Table 2-2 describes the operation of the function keys.

Table 2-2 Function Keys

Key	Description
STATUS	Displays the <i>STATUS</i> screen with options for displaying factory configuration information, and receiver systems information.
SAT INFO	Displays the <i>SAT INFO</i> screen with options for displaying satellite tracking and status information.
CONTROL	Displays the <i>CONTROL</i> screen with options for configuring Series 7400 setup parameters.
MODIFY	<i>MODIFY</i> is not applicable for MS Series receivers.
SESSIONS	Displays the <i>SESSIONS</i> screen with options for displaying the application files directory, storing the current parameter settings as an application file, and options for warm booting the receiver.
LOG DATA	Not applicable.

2.2 Working with Screens and Fields

Table 2-3 gives a summary of the keypad and display operations for the Series 7400 receivers Remote Controller software.

Table 2-3 Keyboard and Display Summary

Key / Symbol	Description
ALPHA	Pages through multiple screen lines, softkey options, or carousel data entry fields.
ENTER	Accepts changes data fields. Press ENTER on the last data field to accept all changes.
CLEAR	Returns the screen to the previous menu level without changing the data fields.
[]	Indicates a carousel data field used to select from a limited options list.
∅	Indicates additional screen lines are accessible by clicking on ALPHA .
< >	Indicates a softkey (menu option).
# and \$	Moves the cursor between fields on the simulated screen.

2.2.1 Types of Fields

Three types of fields are displayed on the simulated LCD display:

- Display-Only fields
- Data-Entry fields
- Carousels

Most fields include two parts—a field description and a reserved area for entering or selecting data.

2.2.2 Display-Only Fields

Display-only fields can appear on any screen. Some screens are composed entirely of display-only fields. For example, the SAT INFO screens show satellite status and tracking information. A cursor is not displayed when a screen is composed entirely of display-only fields. For screens containing combinations of data-entry, carousels, and display-only fields, you are not allowed to move the cursor into display-only fields.

2.2.3 Data-Entry Fields

Data-entry fields accept numeric or alphanumeric input from the keypad. For example, the fields for entering latitude, longitude, and altitude information accept numeric input from the keypad. Data-entry fields are usually displayed when you configure receiver operating parameters, or when you enable receiver functions and options.

2.2.4 Carousels

Whenever square brackets [] appear around an item on the display, you can click the **[ALPHA]** key to change the value to one of a set of options. The square brackets indicate a carousel data entry field.

[ALPHA] is also used to page through more screen lines. Because the simulated MS Series receivers display only has 4 lines, there are times when additional information needs to be accessed. For example, select the **[CONTROL]** menu. Four softkeys become active and the down-arrow symbol ↓ appears in the top left corner of the screen. The down-arrow is the visual cue that selecting **[ALPHA]** pages through more screen information.

2.2.5 Entering Data in Fields

Carousels provide a way of selecting from a limited set of options. Choosing a port number or type of output message is performed with the use of carousels and **ALPHA**. Some data fields involve alphanumeric entry through the keyboard.

Clicking on **ENTER** accepts the data field and moves the cursor to the next input item. To accept all of the selections on the display, click on **ENTER** at the last field. All of the data selections are ignored **CLEAR** is selected while in a data entry screen. **CLEAR** is also used to move back up the menu structure.

The green < and > keys, on the left of the display, are used to move between data entry fields without changing their values.

2.3 Receiver Operation

This section describes the screens provided for use in configuring parameters for the MS Series receivers.

2.3.1 Receiver Screens

The Remote Controller software provides a simulated view of the MS Series screen system. With the Remote Controller software connected to the MS Series receivers, you can monitor and control receiver operation. The Remote Controller screens are summarized in Table 2-4.

Table 2-4 Remote Controller Screen Summary

Menu Key	Softkey – Level 1	Softkey – Level 2
	<POSITION> Displays the latest position, satellite used, position mode, time of fix, and coordinate system (see page 2-16).	
	<VELOCITY> Displays the latest directional velocities, satellites used, position mode, time of fix, and coordinate system (see page 2-18).	
	<ATTITUDE> Displays tilt, yaw, distance, # of satellites used, position mode, time of fix, PDOP, delta time (current minus fix) of moving baseline calculated vector (see page 2-19).	
	<VECTOR> Displays the latest real-time kinematic vector information, the solution RMS, age of corrections, fix mode, number of continuously initialized epochs, solution DOP (Dilution of Precision), and any fault messages (see page 2-21).	<VECTOR AMBIGUITY STATUS> Displays the ambiguity resolution status and search information for real-time kinematic positioning (see page 2-25). <VECTOR BASE STATION STATUS> Displays the real-time kinematic reference station name, location, satellites tracked at the reference station, and the age of RTK corrections (see page 2-27).

† Softkey is displayed only if option is installed on the receiver.

Table 2-4 Remote Controller Screen Summary (Continued)

Menu Key	Softkey – Level 1	Softkey – Level 2
STATUS	<FACTORY CONFIGURATION> Displays the firmware version, installed receiver options, and the memory configuration (see page 2-29).	
	<RECEIVER SYSTEMS> Displays the MS Series operating mode, active input and output messages (see page 2-30).	
	<COORDINATE REFERENCE> Displays the coordinate system, coordinate zone, the datum method, datum, ellipse, projection, site, horizontal plane adjustment, and vertical plane adjustment (see page 2-32).	
SAT INFO	<SV TRACKING> Displays the tracking status of the MS Series channels, including the satellite number assigned to each channel, the satellite elevation and azimuth, method of code tracking, signal to noise ratio values, issue of data ephemeris, and user range accuracy figures (see page 2-33).	
	<SV STATUS> Displays the list of available, healthy, unhealthy, enabled, and disabled satellites (see page 2-35).	

† Softkey is displayed only if option is installed on the receiver.

Table 2-4 Remote Controller Screen Summary (Continued)

Menu Key	Softkey – Level 1	Softkey – Level 2
SESSIONS	<DIRECTORY> Displays the directory listing of the application files stored in memory (see page 2-36).	<PREV> Displays the previous application file. <TIMER> Allows files to be started at a specific time. <DELETE> Deletes the current application file. <START> Starts a new application file.
	<STORE CURRENT> Accepts the file name used for storing the current operating parameters as an application file (see page 2-38).	
	<CLEAR ALL> Erases all application files and defaults all settings.	
LOGDATA	Not applicable for MS Series receivers.	
MODIFY	Not applicable.	

† Softkey is displayed only if option is installed on the receiver.

Table 2-4 Remote Controller Screen Summary (Continued)

Menu Key	Softkey – Level 1	Softkey – Level 2
CONTROL	<BASE STATION> Displays data-entry fields for specifying the reference station location, antenna height, and antenna name (see page 2-39).	<HERE> Applies the most recent position as the base station location. <AVG> Applies the cumulative average position as the base station location.
	<SV ENABLE/DISABLE> Displays fields for enabling and disabling satellites (see page 2-43).	
	<GENERAL CONTROLS> Displays fields for controlling the elevation mask, PDOP mask, RTK mode, and motion state (see page 2-44).	
	<1 PPS OUTPUT> Displays fields for enabling or disabling 1 PPS output and specifying the port number used for outputting ASCII time tags (see page 2-46).	

† Softkey is displayed only if option is installed on the receiver.

Table 2-4 Remote Controller Screen Summary (Continued)

Menu Key	Softkey – Level 1	Softkey – Level 2
CONTROL	<p><SERIAL PORT OUTPUT> Displays fields for configuring the communication parameters for the MS Series serial ports (see page page 2-55).</p>	<p><NMEA OUTPUT> Displays fields and softkey options for setting up the NMEA-0183 message type, serial port for outputting NMEA messages, and the message output frequency (see page page 2-47).</p> <p><STREAMED OUTPUT> Displays fields for controlling the output of streamed messages (see page 2-49).</p> <p><RT17/BINARY OUTPUT> Displays fields for configuring the output of raw GPS data messages (see page 2-51).</p> <p><CMR/RTCM OUTPUT> Displays fields for configuring CMR and RTCM (see page 2-53).</p>
	<p><SERIAL PORT SETUP> Displays softkey options for setting up the serial ports.</p>	
	<p><JX-1100 SETUP> Displays fields for interfacing the MS Series receiver to a Clarion JX-1100 radio/modem (see page 2-54).</p>	
	<p><INPUT SETUP> Displays fields for selecting an RTCM reference station and setting the range used for switching between DGPS and RTK (see page 2-53).</p>	

† Softkey is displayed only if option is installed on the receiver.

2.3.2 POSITION Screen

The *POSITION* screen displays the latest position, satellites used, position mode, time of fix, and coordinate system.

To display the *POSITION* screen:

1. Click **CLEAR** several times until the *Main* screen appears.
2. Click the **<POSITION>** softkey to display:

```
LAT: 37°2326.0070" N      3D      RTK (FIX)
LON: 122°0215.9993" W      22:00:34.2 UTC
HGT:    -0.026 m EHT          WGS-84
SVS: 20, 24, 9, 7, 4, 12, 5.
```

Use the field descriptions in Table 2-5 to understand the position information.

Table 2-5 POSITION Fields

Field	Description
LAT	Displays the latitude coordinate of the antenna phase center, relative to the selected coordinate system.
LON	Displays the longitude coordinate of the antenna phase center, relative to the selected coordinate system.
HGT	Displays the height of the antenna phase center, relative to the selected coordinate system. (EHT = Ellipsoidal Height, GHT = Geoidal Height)
SVS	Identifies the satellites used to compute the position solution. The satellites displayed can be a subset of the total satellites tracked by the receiver. In RTK mode, the common satellites tracked by the reference and rover stations are displayed.

Table 2-5 POSITION Fields (Continued)

Field	Description
Fix Mode	<p>Identifies the method used to compute position solutions:</p> <p>OLD POSITION – No position computed</p> <p>2D AUTONOMOUS – Stand-alone horizontal solution with constrained height</p> <p>3D AUTONOMOUS – Stand-alone horizontal and vertical solution</p> <p>3D RTK (FLOAT) – Real-Time Kinematic, differential position solution with float ambiguities</p> <p>3D RTK (FIX) – Real-Time Kinematic, differential position solution with fixed ambiguities</p> <p>DGPS – Differential GPS solution using pseudorange correction data</p>
Fix Time	<p>Displays the time when the position fix is computed. The fix time always lags behind the current time. The displayed time is given in terms of UTC, which is different from GPS time by an integer number of seconds.</p>
Coordinate System	<p>Displays the coordinate system. The receiver performs all calculations in terms of the GPS coordinate system, WGS-84. Using the Configuration Toolbox software, you can select a local datum and projection for display and output of local coordinates. Press ALPHA to view the local projected coordinates.</p>

2.3.3 VELOCITY Screen

The *VELOCITY* screen lets you display the East, North and Up velocities of the solution.

To display the *VECTOR* screen:

1. Click **[CLEAR]** several times until the *MAIN* screen appears.
2. Click the **<VELOCITY>** softkey to display:

```

↓E: -0.156 KPh      3D   RTK/FIX
   N: +0.542 KPh      20:04:58.0 UTC
   U: +2.034 KPh      WGS-84
S US:18,19,16,1,27,13,3 .

```

Use the field descriptions in Table 2-6 to read the status information.

Table 2-6 VELOCITY Fields

Field	Description
E	Displays velocity in the East direction.
N	Displays velocity in the North direction.
U	Displays velocity in the Up direction.

2.3.4 ATTITUDE Screen

The *ATTITUDE* screen lets you display the tilt, yaw, distance, number of satellites used, position mode, time of fix, PDOP, and delta time of the moving baseline calculated.



Note – This screen is only applicable in an MS Series receiver setup for Moving Base RTK operation (MS860 or cabled method, section 7.4.2) with either NMEA AVR messages or ATTITUDE INFO messages switched on.

To display the *ATTITUDE* screen:

1. Click **CLEAR** several times until the *MAIN* screen appears.
2. Click the **<ATTITUDE>** softkey to display:

```
TILT: +0.20 deg      RTK/FIX
YAW:  +180.03 deg   22:30:44.6 UTC
DIST:   +2.421 m
SVs: 7              PDOP: 2.2 dT:0.21 .
```

Use the field descriptions in Table 2-7 to read the status information.

Table 2-7 ATTITUDE Fields

Field	Description
TILT	Displays vertical angle in degrees between master and slave antenna. Tilt is zero when both are on same horizontal plane. Tilt is positive when slave is above master.
YAW	Displays horizontal angle in degrees between master and slave antenna, with respect to local zone's North axis.
DIST	Displays distance between master and slave antenna.
SVs	Displays number of satellites used in the moving baseline
PDOP	Displays Position Dilution of Precision of the position fix.
dT	Displays delta time between moving baseline solution and current time. This indicates latency of output attitude information.

2.3.5 VECTOR Screen

The *VECTOR* screen lets you display the latest Real-Time Kinematic vector information, the solution RMS, age of corrections, fix mode, number of continuously initialized epochs, solution Dilution Of Precision and any faults.



Note – Vector information is not displayed for a DGPS solution.

To display the *VECTOR* screen:

1. Click **CLEAR** several times until the *MAIN* screen appears.
2. Click the **<VECTOR>** softkey to display:

```
↓E: +1287.312  RMS:  0.024  RTK/FIX
   N:  -504.791  PROP:   0.8  SVS:5
   U:   +10.026   N:   3247
   R:  1382.782  DOP:   1.8  UNKNOWN  .
```

Use the field descriptions in Table 2-8 to read the status information.

Table 2-8 VECTOR Fields

Field	Description
E	Displays the East component of the vector between the reference station and rover station antenna phase center.
N	Displays the North component of the vector between the reference station and rover station antenna phase center.
U	Displays the Up component of the vector between the reference station and rover station antenna phase center.
R	Displays the Length component of the vector between the reference station and rover station antenna phase center.
RMS	Displays the root mean square (RMS) error of the measurement residuals in units of L1 cycles. For fixed-ambiguity (RTK/FIX) solutions, the RMS value should be less than 0.100 cycles. In a float-ambiguity (RTK/FLOAT) mode, the RMS value is generally less than 10 cycles.
Fix Mode	Displays the method used to compute position solutions: N/A – Stand-alone position or no position computed RTK/FLOAT – Real-Time Kinematic, differential position solution with float ambiguities RTK/FIX – Real-Time Kinematic, differential position solution with fixed ambiguities
PROP	Displays the age of the Real-Time Kinematic corrections coming from the reference station. The receiver is designed such that occasional losses of reference station data packets do not cause a loss in position and vector solutions. The PROP time should normally increase from 0.2 seconds to 1.4 seconds. If a 4000SSE/SSi is used as a reference station, the PROP time grows to 2.2 seconds or more.

Table 2-8 VECTOR Fields (Continued)

Field	Description
SVs	Identifies the number of satellites used to compute the solution.
N	Displays the number (N) of seconds the receiver has been in the current mode (Fix / Float).
DOP	<p>Displays the Dilution Of Precision of the position fix. The DOP value gives an indication of the satellite geometry quality. Low DOP values indicate strong measurement geometry, while values greater than 5.0 indicate weak geometry.</p> <p>When the receiver is put in a STATIC mode using the general controls, the DOP value decreases over time. The DOP value displayed while STATIC is Relative Dilution Of Precision, and when KINEMATIC, is the Geometric Dilution Of Precision.</p>



Caution – Be suspicious of position and vector information if the DOP is greater than 5.0.

2.3.6 Error Messages

An error message displays to indicate any problems in the Real-Time Kinematic position fix. Table 2-9 lists the possible errors.

Table 2-9 RTK Position Fix Error s

Error Message	Description
UNKNOWN	Unknown error condition
< MIN SVS	Need more satellites to compute a position fix
HIGH DOP	Dilution Of Precision exceeds mask value
SYNC'D DATA	Need synchronized data between reference station and rover receiver
NO REF DATA	Not receiving valid data from the reference station
NEED REF POS	Waiting for valid reference position message from the reference station
COMMON SVS	Less than 4 common satellites between reference station and rover receivers
C/P MISMATCH	Reference and rover receivers are tracking different types of code measurements
DIFF PDOP	Differential DOP value exceeds mask value
NO L2 PHASE	Need L2 phase data to start ambiguity search process
POOR RMS	RMS figure is considered too high.
NO SEARCH	Ambiguity search has not been started
VERIFY FAIL	Ambiguities failed the verification process
# SVS < MIN	Need at least 5 common satellites to start search
SUSPECT LINE	Known baseline entered could be incorrect
HIGH RMS	Search cancelled due to high RMS
LOW RATIO	Search cancelled due to low ratio
PROP CANCEL	Search cancelled because it took too long
HIGH SRH DOP	Search satellites have poor geometry – cannot resolve

2.3.7 VECTOR AMBIGUITY STATUS Screen

The *VECTOR AMBIGUITY STATUS* screen allows you to display the ambiguity resolution status and search information for Real-Time Kinematic positioning.

To display the *VECTOR AMBIGUITY STATUS* data:

1. Click **CLEAR** several times until the *MAIN* screen appears.
2. Click the **<VECTOR>** softkey.
3. Click **ALPHA** to display:

```
↓SV: 02 07 09 04 05 24 26 xx
L1: R R R R S S F
L2: - - - - - - -
REF SV:12 RATIO: 128.19 RMS: 0.024 .
```

Use the field descriptions in Table 2-10 to learn the vector ambiguity status.

Table 2-10 VECTOR AMBIGUITY STATUS Fields

Field	Description
SV	Displays the satellites (SVs) used for the RTK vector.
L1,L2	Displays a list of the L1 and L2 ambiguity resolution status codes for each satellite. The search process is automatically handled by the receiver. The ambiguity search process involves: F – Estimation of float ambiguities S – Search the ambiguities V – Verify that ambiguities are valid R – Resolve ambiguities
REF SV	Displays the pseudorandom number (PRN) of the satellite used to form double difference measurements.
RATIO	Displays the separation between the best ambiguity candidate and the next best. A large ratio (>10) indicates that the best candidate is significantly better than the next best. Once the ambiguities are resolved, the ratio value is retained.
RMS	Displays the root mean square (RMS) error of the best ambiguity search candidate. The RMS value at resolution is retained.

2.3.8 VECTOR BASE STATION STATUS Screen

The *VECTOR BASE STATION STATUS* screen lets you display the Real-Time Kinematic reference station name, location, satellites tracked at the reference station and the age of the RTK corrections. This display is used for RTK positioning at the rover receiver.

To view the status of the vector base station:

1. Click **CLEAR** several times until the main screen appears.
2. Click the **<VECTOR>** softkey, and click **ALPHA**.
3. Click **ALPHA** again to display:

```
↓BASE STATION          NAME: BASE
LAT: 37°2326.0000" N  HGT:      +0.000m
LON: 122°0216.0000" W  AGE:      1.2
SVS: 20, 6, 12, 9, 5, 4.
```

Use the field descriptions in Table 2-11 to learn the current status of the vector base station.

Table 2-11 VECTOR BASE STATION STATUS Fields

Field	Description
NAME	Displays the 4-character designation assigned to the reference station.
LAT	Displays the latitude coordinate of the antenna phase center location at the reference station based on the WGS-84 datum.
LON	Displays the longitude coordinate of the antenna phase center location at the reference station based on the WGS-84 datum.
HGT	Displays the height of the antenna phase center location at the reference station based on the WGS-84 datum.
AGE	Displays the age of the Real-Time Kinematic measurement correction data. Under normal operation, the age does not exceed 2 seconds. If however, the radio link between reference and rover stations is intermittent, then the age field could exceed 3 seconds.
SVS	Displays the pseudorandom numbers (PRNs) of the satellites (SVs) tracked by the reference station.

2.3.9 FACTORY CONFIGURATION Screen

The *FACTORY CONFIGURATION* screen allows you to display the firmware version, installed options and memory configuration of the MS Series receivers.

To display the receiver configuration and the installed options:

1. Click **[STATUS]** to display the *STATUS* menu.
2. Click the **<FACTORY CONFIGURATION>** softkey to display:

```

↓FACTORY CONFIGURATION (STATUS)
MS750
FIRMWARE: 1.05 AUG 22 1999
SERIAL: 220177076.

```

You can click **[ALPHA]** to view installed options.

```

↓FACTORY CONFIGURATION (STATUS)
CMR INPUT CMR OUTPUT RTCM INPUT
RTCM OUTPUT JX-1100 TSC1/TDC1
GSOFF, RT17 20 Hz.

```



Note – Options in your receiver may differ.

Use the field descriptions in Table 2-12 to identify the receiver configuration and factory installed options.

Table 2-12 FACTORY CONFIGURATION Fields

Field	Description
FIRMWARE	Displays the version number and release date of the firmware.
Serial Number	Displays the receiver serial number.
Options	Displays the list of installed receiver options.

2.3.10 RECEIVER SYSTEMS Screen

The *RECEIVER SYSTEMS* screen lets you list the operating mode of MS Series receivers, and currently active output and input messages. This screen displays a summary of the MS Series operation without having to page through the *CONTROL* screens.

To view the status the receiver:

1. Click **[STATUS]** to display the *STATUS* menu.
2. Click the **<RECEIVER SYSTEMS>** softkey to display:

```
↓  MODE: ROVER/RTK
   OUTPUTS: GGA(A),STREAMED(B-1)

   INPUTS : CMR(B-2).
```

Use the field descriptions in Table 2-13 to learn the current status of the receiver.

Table 2-13 RECEIVER SYSTEMS Fields

Field	Description
MODE	<p>Displays the receiver positioning mode:</p> <p>AUTONOMOUS – Stand-alone positioning mode. Activated automatically by receiver at power-up.</p> <p>BASE STATION – Reference station. Enabled using CONTROL <SERIAL PORT OUTPUT>.<CMR/RTCM OUTPUT></p> <p>ROVER/RTK – RTK rover which is receiving reference station correction data to compute solutions.</p> <p>ROVER/DGPS – DGPS rover which is using pseudorange correction data to compute position solutions.</p>
OUTPUTS	<p>Lists the currently active outputs and output port index. NMEA GGA strings are being output port A, while streamed data is being output to port B-1 in the example above. A list of receiver output messages follows:</p> <p>No Outputs – No data is currently being output</p> <p>CMR – Trimble-formatted RTK data output</p> <p>RTCM – RTCM SC-104 formatted correction data.</p> <p>NMEA – ASCII messages</p> <p>STREAMED – General Serial Output records</p> <p>RT17/BINARY – Raw data output</p> <p>1 PPS – One Pulse Per Second output</p>
INPUTS	<p>Lists the currently active inputs and input port index. CMR messages are received on port B-2 in the example above. Receiver input messages include:</p> <p>CMR - Trimble-formatted RTK data input.</p> <p>RTCM - RTCM SC-104 formatted correction data.</p>

2.3.11 COORDINATE REFERENCE Screen

The *COORDINATE REFERENCE* screen displays the coordinate system, coordinate zone, the datum method, datum, ellipse, projection, site, horizontal plane adjustment, and vertical plane adjustment.

To view the *COORDINATE REFERENCE* screen:

1. Press **[STATUS]**.
2. Press **<COORDINATE REFERENCE>** to display the following screen:

```
DATUM:WGS-84
↓COORD SYSTEM:WGS-84
  ZONE:None
DATUM TRANS:None
  ELLIPSE:WGS-84
  PROJECTION:None
    SITE:None
  HORIZ PLANE:None
  VERT PLANE:None.
```

2.3.12 SV TRACKING Screen

The *SV TRACKING* screen allows you to list the tracking status of the MS Series channels. The satellite PRN number assigned to each channel is shown with elevation/azimuth, method of code tracking, signal-to-noise ratio values, ephemeris issue of data, and the user range accuracy figure.

To view the SV tracking status of all receiver channels:

1. Click **SAT INFO** to display the *SAT INFO* menu.
2. Click the **<SV TRACKING>** softkey to display:

↓CH	SV	EL/AZ	CODE	SNR/L2	IOD	URA
1	6	37/297	C/E	49/27	127	32
2	9	63/301	C/E	55/25	101	32
3	16	41/124	C/E	51/29	197	32
4						
5	5	67/166	C/E	52/28	56	32
6	4	15/48	C/E	32/10	132	32
7						
8						
9	20	51/194	C/E	50/29	12	32.

Use the field descriptions in Table 2-14 to learn the SV tracking status of all receiver channels.

Table 2-14 SV TRACKING Fields

Field	Description
CH	Displays the receiver channel number (1–9).
SV	Displays the pseudorandom number (PRN) of the satellite tracked on the channel (1–32).
EL/AZ	Displays the elevation and azimuth of the satellite.
CODE	Displays the type of code measurements tracked on the channel. The the channels of the L1 always indicate C (C/A code). For the L2 channels, a Trimble proprietary tracking scheme is used and is designated with E (E-code).
SNR/L2	Displays the Signal-to-Noise ratio of the satellite tracked on the channel.
IOD	Displays the Issue Of Data number transmitted by the satellite tracked on the channel. Changes in the IOD number indicate a change to a new ephemeris.
URA	Displays the User Range Accuracy, in meters. URA is a figure of merit value used to measure the quality of the broadcast satellite ephemeris.

2.3.13 SV STATUS Screen

The *SV STATUS* screen allows you to list the available, healthy, unhealthy and disabled satellites.

To view the current status of all NAVSTAR GPS satellites:

1. Click **[SAT INFO]** to display the *SAT INFO* menu.
2. Click the **<SV STATUS>** softkey to display:

```

↓SV STATUS
ACTIVE:
1,2,3,4,5,6,7,8,9,10,12,13,14,15,16,17,18
'
19,20,21,22,23,24,25,26,27,29,30
UNHEALTHY:
24

DISABLED:
31.

```

Use the field descriptions in Table 2-15 to learn the status of all satellites.

Table 2-15 SV STATUS Fields

Field	Description
ACTIVE	Displays the list of active satellites that have been launched and considered part of the GPS constellation.
UNHEALTHY	Displays the list of satellites deemed unhealthy by the GPS ground segment. By default, the receiver does not use unhealthy satellites in position solutions. Satellite health is derived from the broadcast ephemeris or satellite almanac.
DISABLED	Identifies the satellites which are manually disabled for the receiver. Use [CONTROL] <SV ENABLE/DISABLE> to disable a satellite.

2.3.14 APPLICATION FILE SESSIONS Screen

The *APPLICATION FILE SESSIONS* screen provides a directory listing of the saved application files. An application file can be deleted or started from this screen.

To display the Application File directory on the receiver:

1. Click **[SESSIONS]** to display the *APPLICATIONS* menu.
2. Click the **<DIRECTORY>** softkey to display:

```
APP_FILE ( 0 ) <PREV>
JUN 23 1999 21:12:50.0 UTC <TIMER>
123 BYTES <DELETE>
<START>.
```

3. Perform any of the following actions:
 - Click the **<PREV>** softkey to scan through the previous list of application files stored in the directory.
 - Click the **<TIMER>** softkey to set a time in the future when an application file will be started.
 - Click the **<DELETE>** softkey to remove the application file from the directory.
 - Click the **<START>** softkey to apply all of the application file parameters to the receiver.
 - Click **[ALPHA]** to scan forward through the application file listings stored in the directory.

Table 2-16 describes the *APPLICATION FILE SESSIONS* screen fields.

Table 2-16 APPLICATION FILE SESSIONS Fields

Field	Description
Application File Name / Index	Displays the file name or index number assigned to the application file.
Creation Date / Time	Displays the date and time when the application file is created, in UTC.
File Size	Displays the size of the application file, in bytes.

2.3.15 STORE CURRENT Screen

The *STORE CURRENT* screen lets you store the current MS Series settings into the named application file.

To store the current receiver parameter settings in an application file:

1. Click **[SESSIONS]** to display the *APPLICATIONS* menu.
2. Click the **<STORE CURRENT>** softkey to display:



```
STORE APPLICATION FILE
FILE NAME:
"
```

3. Enter an eight-character name for the application file. The software stores the creation date and time with the file.

2.3.16 CLEAR ALL Screen

The *CLEAR ALL* screen lets you erase all application files and reset to factory settings.

To erase all files and reset the factory default values:

1. Click **[SESSIONS]** to display the *APPLICATIONS* menu.
2. Click the **<CLEAR ALL>** softkey.



Note – This erases the ephemeris stored in the receiver as well. If only a reset of defaults is required, use procedure in section 2.3.14 to start the default application file.

2.3.17 BASE STATION Screen

The *BASE STATION* screen lets you specify the reference station location, antenna height, name and output port for real-time corrections.

To set the *BASE STATION* parameters:

1. Click **CONTROL** to display the *CONTROL* menu.
2. Click the **<BASE STATION>** softkey to display:

```

BASE STATION (CONTROL)                <HERE>
LAT: 372329.35788" [N]
LON: 1220213.80337" [W]
HGT: [+]10140.350m   ANT. HT.: 000.000m.

```

3. Set the *BASE STATION* parameters using the information in Table 2-17.

Table 2-17 RTK BASE STATION Fields

Field	Description
LAT	Identifies the latitude coordinate of the reference station ground mark based on the WGS-84 datum.
LON	Identifies the longitude coordinate of the reference station ground mark based on the WGS-84 datum.
HT	Identifies the height or altitude of the reference station ground mark based on the WGS-84 datum.
ANT. HT.	Identifies the vertical distance between the ground mark to the antenna phase center.

4. If known coordinates are not available, Click the **<HERE>** softkey to find the approximate location of the reference station. The receiver must be tracking at least 4 satellites with a DOP value less than 3.



Warning – The reference station coordinates must be known to better than 10 meters to achieve utmost RTK accuracy. The position derived from the <HERE> softkey is in error by as much as 150 meters and therefore should not be relied on. Use the averaging capabilities within the receiver to obtain more accurate coordinates. For more information, see Base Station Averaging in the next section.

Be careful to get the North/South, East/West indicators correct. If the input reference station coordinates are more than 5 km different from the MS Series-computed coordinates, no RTK corrections will be output and a warning is issued.

2.3.18 Base Station Averaging

Tests have shown that reference station coordinate accuracies of better than 10 meters can be obtained by averaging autonomous GPS positions over a period of time greater than 30 minutes. The MS Series receivers can compute cumulative position averages.



Note – The receiver must be doing autonomous GPS solutions, not RTK (fixed) or RTK (float), or DGPS solutions

To implement base station averaging:

1. Click **[CONTROL]**, then click the **<GENERAL CONTROL>** softkey to display the following screen:

```
GENERAL (CONTROL)
ELEV MASK: 13      PDOP MASK: 07
RTK MODE: [LOW LATENCY]
MOTION: [KINEMATIC].
```

2. Set the *MOTION* field to *STATIC*.
3. Click **[CONTROL]**, then click the **<BASE STATION>** softkey to display the following screen:

```
BASE STATION (CONTROL)                                <AVG>
LAT: 372329.35788"[N]
LON: 1220213.80337"[W]
HGT: [+J0140.350m   ANT. HT.: 000.000m.
```

The **<HERE>** softkey is now replaced with the **<AVG>** softkey.

4. Click the **<AVG>** softkey to enter the current averaged position in the coordinate fields.

Adjacent to the **<AVG>** softkey is the display of the hours, minutes, and seconds elapsing since the start of the computation of averaged position. The time begins when the **MOTION** field is set to *STATIC*. Each time the **<AVG>** softkey is clicked, the latest values for averaged position and the length of time used to compute the averaged position solution is displayed on the screen.

2.3.19 SV ENABLE/DISABLE Screen

The *SV ENABLE/DISABLE* screen allows you to control the MS Series tracking of satellites. To display the screen:

1. Click **CONTROL** to display the *CONTROL* menu.
2. Click the **<SV ENABLE/DISABLE>** softkey to display:

```
SV CONTROL
SV: [ALL] STATE: [ENABLE  ]
.
```

3. Set the *SV ENABLE/DISABLE* parameters using the information in Table 2-18. First, select ALL or enter the pseudorandom number (PRN) of the satellite in the *SV* field, then select the setting for the *STATE* field.

Table 2-18 SV ENABLE/DISABLE Fields

Field	Description
SV	Selects ALL satellites or accepts the pseudorandom number (PRN) of a specific satellite (1–32). The ENABLE/DISABLE state of each satellite can be set individually.
STATE	Assigns the ENABLE/DISABLE state to the satellite or all satellites. ENABLE – Enables tracking for the specified satellite(s). DISABLE – Do not track the specified satellite(s) or use it in a position solution. FORCE USE – Override health status of the satellite(s) and use the satellite(s) in solution.



Warning – Disabling or setting the MS Series receivers to override satellite health warnings can adversely effect receiver performance.

2.3.20 GENERAL CONTROLS Screen

The *GENERAL CONTROLS* screen allows you to control the MS Series Elevation Mask, PDOP Mask, RTK Mode, and motion state.

To set the *GENERAL CONTROLS* parameters:

1. Click **CONTROL** to display the *CONTROL* menu.
2. Click the **<GENERAL CONTROLS>** softkey to display:

```
GENERAL (CONTROL)
ELEV MASK: 13      PDOP MASK: 07
RTK MODE: [LOW LATENCY]
MOTION: [KINEMATIC].
```

3. Set the *GENERAL CONTROLS* parameters using the information in Table 2-19.

Table 2-19 GENERAL CONTROLS Fields

Field	Description
ELEV MASK	Selects the Elevation Mask. This is the elevation angle to which satellites are tracked down the horizon. The Elevation Mask is measured from the local horizon towards the zenith, 0–90°. The default is 13.
PDOP MASK	Position Dilution of Precision Mask. The default is 7.
RTK MODE	Two modes of operation are available for RTK operation - Low Latency mode and Synchronized mode. Low Latency mode delivers low latency positions at rates up to 20 Hz with a small degradation in accuracy. Synchronized mode delivers the highest accuracy position at a maximum update rate of 10 Hz and increased latency, see Chapter 1.
MOTION	Sets the motion state of the receiver to KINEMATIC or STATIC. Select Kinematic when the receiver is moving. The STATIC mode causes averaging of the computed position. STATIC mode is automatically selected by the receiver if the receiver is configured as an RTK or DGPS reference station.



Warning – An Elevation Mask of 90° stops the Series 7400 receivers from tracking any satellites. The default Elevation Mask is 13° and should not be changed.

2.3.21 1 PPS OUTPUT Screen

The *1 PPS OUTPUT* screen lets you control the output of a one pulse per second signal and the port of an associated ASCII time tag. To enable or disable 1 PPS and ASCII Time Tag output:

1. Click **CONTROL** to display the *CONTROL* menu.
2. Click **ALPHA**.
3. Click the **<1 PPS OUTPUT>** softkey to display:

```
1 PPS (CONTROL)

1 PPS: [ON ] ASCII TIME TAG PORT: A
-
```

4. Set the 1 PPS output parameters based on the information in Table 2-20.

Table 2-20 1 PPS OUTPUT Fields

Field	Description
1 PPS	Enables or disables 1 PPS output (ON or OFF).
ASCII TIME TAG PORT	Enables or disables the transmission of an ASCII time tag message through a port. Select OFF or a port designation.

2.3.22 NMEA/ASCII OUTPUT Screen

The *NMEA/ASCII OUTPUT* screen allows you to setup output message type, serial port and the output frequency. The NMEA-0183 (Version 2.1) standard contains messages for integrating GPS information with other systems. The standard is based around ASCII data beginning with the \$ and ending with a carriage return, line feed. Null fields still follow a comma (,) delimiter but contain no information.

The checksum value is separated from the last field in an NMEA message by the asterisk (*) delimiter. The checksum is the 8-bit exclusive OR of all characters in the message, including the commas, between but not including the \$ and * delimiters. The hexadecimal result is converted to two ASCII characters (0-9, A-F). The most significant character appears first. For information about the subset of NMEA output messages supported by the MS Series receivers, see Chapter 3, NMEA-0183 Output.

To control NMEA output:

1. Click **CONTROL** to display the *CONTROL* menu.
2. Click **ALPHA**.
3. Click the **<SERIAL PORT OUTPUT>** softkey.
4. Click the **<NMEA/ASCII OUTPUT>** softkey to display:

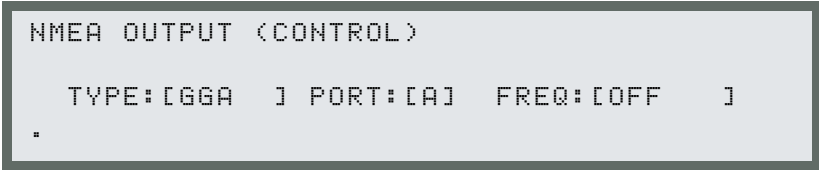

```
NMEA OUTPUT (CONTROL)
TYPE: [GGA ] PORT: [A] FREQ: [OFF ]
.
```

5. Set the NMEA output parameters based on the guidelines in Table 2-21.

Table 2-21 NMEA OUTPUT Fields

Field	Description
TYPE	Selects the NMEA message type.
PORT	Assigns the serial port for outputting NMEA messages.
FREQ	Assigns a frequency for outputting NMEA messages in either Hz, seconds, or minutes.



Note – The *RECEIVER SYSTEMS* screen gives a summary of the messages being output from the MS Series ports. For more information, see *RECEIVER SYSTEMS* Screen, page 2-30.

2.4 STREAMED OUTPUT Screen

The *STREAMED OUTPUT* screen allows you to set up streamed output messages. For information about controlling the streamed output message formats, see Command Packet 4Ah on page 7-7.

To configure the receiver to stream output messages:

1. Click **CONTROL** to display the *CONTROL* menu.
2. Click **ALPHA**.
3. Click the **<SERIAL PORT OUTPUT>** softkey.
4. Click the **<STREAMED OUTPUT>** softkey to display:

```
STREAMED OUTPUT (CONTROL)
PORT:[A]
TYPE:[POSITION TIME    ]
FREQ:[OFF    ]      OFFSET (SEC):00.
```

Table 2-22 describes the *STREAMED OUTPUT* screen fields.

Table 2-22 STREAMED OUTPUT Field s

Field	Description
PORT	Assigns the serial port used for streamed data output.
TYPE	Assigns the message type to output on the port: POSITION TIME DOP INFO LAT, LONG, HT CLOCK INFO XYZ POSITION POSITION VCV LOCAL LLH POSITION SIGMA LOCAL ENU BRIEF SV INFO DELTA XYZ DETAIL SV INFO TPLANE ENU RECEIVER SERIAL VELOCITY TIME/UTC INFO ATTITUDE INFO
FREQ	Assigns a frequency for outputting messages in either Hz, seconds, or minutes.
OFFSET	Assigns an offset value for the number of seconds elapsing while messages are output relative to the frequency (FREQ). If the frequency is 5 seconds and the offset is 2 seconds, then the message is output at measurements epochs 2, 7, 12, 17,



Note – The *RECEIVER SYSTEMS* screen gives a summary of the messages being output from the Series 7400 ports. For more information, see *RECEIVER SYSTEMS* Screen, page2-30.

2.4.1 RT17/BINARY OUTPUT Screen

The *RT17/BINARY OUTPUT* screen allows you to set up raw GPS data output messages. For additional information, see Command Packet 56h, GETRAW, page 5-8 and Report Packet 57h, RAWDATA, page 6-43.

To configure the receiver for raw binary data output:

1. Click **CONTROL** to display the *CONTROL* menu.
2. Click **ALPHA**.
3. Click the **<SERIAL PORT OUTPUT>** softkey.
4. Click the **<RT17/BINARY OUTPUT>** softkey to display:

```
RT17/BINARY OUTPUT (CONTROL)
      PORT [A      ]   CONCISE [ON ]
MEASUREMENTS [1 HZ ]   R-T FLAGS [ON ]
      POSITIONS [1 HZ ]   EPHEMERIS [ON
].
```

5. Use the field descriptions in Table 2-23 to configure the receiver for raw binary data output.

Table 2-23 RT17/BINARY OUTPUT Fields

Field	Description
PORT	Assigns the serial port (PORT) used for RT17 binary output.
CONCISE	Selects between Concise and Expanded measurement output formats.
MEASUREMENTS	Sets the raw GPS measurement output rate.
R-T FLAGS	Provides Real-Time Flags for enabling and disabling enhanced measurement records with IODE information and cycle slip counters for each satellite. This data can be useful to computer programs processing data for real-time applications.
POSITIONS	Sets the output rate for position measurements.
EPHEMERIS	Determines whether or not the Ephemeris is automatically formatted and transmitted whenever a new IODE (Issue of Data Ephemeris) becomes available.



Note – The RECEIVER SYSTEMS screen gives a summary of the messages being output from the MS Series ports. For more information, see RECEIVER SYSTEMS Screen, page 2-30.

2.4.2 CMR/RTCM OUTPUT Screen

The CMR/RTCM OUTPUT screen lets you configure CMR and RTCM base station output settings.

To configure the receiver CMR/RTCM output:

1. Click **[CONTROL]** to display the *CONTROL* menu.
2. Click **[ALPHA]**.
3. Click the **<SERIAL PORT OUTPUT>** softkey.
4. Click the **<CMR/RTCM OUTPUT>** softkey to display:

```

CMR/RTCM (CONTROL) RTCM VERSION [2.1]
RTCM PORT [OFF]      TYPE [RTK]   ID 0000
CMR PORT [A]        NAME cref    ID 0000
CMR TYPE [CMR PLUS] BASE [STATIC]
.

```

5. Use the field descriptions in Table 2-24 to configure one or more serial ports.

Table 2-24 CMR/RTCM OUTPUT Fields

Field	Description
RTCM VERSION	Selects version of RTCM to output.
RTCM PORT	Assigns the serial port for RTCM output.
TYPE	Sets the desired RTCM types: Type 1 - DGPs corrections Type 9-3 - DGPS corrections Type RTK - RTK data only (Type 18, 19) Type RTK & 1 - RTK and DGPS corrections (Type 1, 18, 19)
ID	Allows input of a station ID.

Table 2-24 CMR/RTCM OUTPUT Fields (Continued)

Field	Description
CMR PORT	Assigns the serial port for CMR Output.
NAME	Assigns a 4-character designator to the reference station.
ID	Allows input of a station ID.
CMR TYPE	Sets the desired CMR types: CMR PLUS - Outputs base data at a 1 Hz rate for RTK application CMR 5Hz - Required for 5 Hz Synchronized RTK and higher accuracy Low Latency positioning CMR 10Hz - Required for 10 Hz Synchronized RTK and higher accuracy Low Latency positioning CMR - Required for applications where roving receivers include Trimble 4000 Series.)
BASE	Sets the motion state of the base station. Set to MOVING if base is part of a Moving Base RTK configuration.

2.4.3 SERIAL PORT SETUP Screen

The *SERIAL PORT SETUP* screen lets you configure the serial port baud, data bits, parity, stop bits and flow control settings.

To configure the serial communication parameters for a port:

1. Click **CONTROL** to display the *CONTROL* menu.
2. Click **ALPHA**.
3. Click the **<SERIAL PORT SETUP>** softkey to display:

```
SERIAL PORT SETUP (CONTROL)
[PORT A] [9600 ] [8-NONE-1] [NONE ]
"
```

4. Use the field descriptions in Table 2-25 to configure one or more serial ports.

Table 2-25 SERIAL PORT SETUP Fields

Field	Description
PORT	Assigns the serial port to configure.
BAUD	Assigns the baud rate setting in the range: 2400, 4800, 9600, 19.2K, 38.4K, 57.6K, 115K.
DATA	Assigns the data, parity, and stop bit settings: 8 - NONE - 1 eight data bits, no parity and one stop bit (default) 8 - ODD - 1 eight data bits, odd parity and one stop bit. 8 - EVEN - 1 eight data bits, even parity and one stop bit.
FLOW CONTROL	Enables or disables CTS/RTS (Clear To Send/ Request To Send) flow control negotiation for Port A.

2.5 INPUT SETUP Screen

The *INPUT SETUP* screen lets you allow the receiver to automatically select an RTCM station or to manually specify a RTCM Station ID, and specify the distance used by the receiver to switch between the use of RTK and DGPS correction processing techniques.

To configure the input setup parameters:

1. Click **CONTROL** to display the *CONTROL* menu.
2. Click **ALPHA**.
3. Click the **<INPUT SETUP>** softkey to display:

```
INPUT SETUP (CONTROL)
USE RTCM STATION [ONLY]: 0000
RTK/DGPS AUTO SWITCH RANGE: 10.0KM
"
```

4. Use the field descriptions in Table 2-26 to configure which RTCM base station the rover receiver is using to calculate solutions and the range that the receiver automatically switches between RTK or DGPS corrections.

Table 2-26 INPUT SETUP Fields

Field	Description
USE RTCM STATION	Assigns the identification number of the RTCM Station used for receiving RTCM corrections. You can choose ANY or ONLY. If you choose ANY, the receiver selects any RTCM station for receiving RTCM corrections. If you choose ONLY, you must manually enter the number of the desired RTCM Station, a value ranging from 0–1023.
RTK/DGPS AUTO SWITCH RANGE	Defines the distance used to determine when the Series 7400 receiver automatically switches between the use of RTK and DGPS solutions. The default is 10.0 Km.

2.6 JX-1100 SETUP Screen (Requires Clarion Radio/Modem)

The *JX-1100 SETUP* screen allows you to setup the MS Series receivers to operate with a Clarion JX-1100 radio/modem. There are two modes of setup, one for configuring a reference station, the other for configuring a rover. The reference station setup provides the ability for setting a local address, transmission channel and repeater routing. The rover setup contains parameters for both receiving reference station data as well as reporting position information to a central tracking site.

To configure a JX-1100 radio:

1. Click **CONTROL** to display the *CONTROL* menu.
2. Click **ALPHA** twice.
3. Click the **<JX-1100 SETUP>** softkey to display:

```
JX-100 SETUP (CONTROL) [PORT 1] [OFF]
[ROVER]      LOC ADR: 010 NETWORK:[ON ]
TX CHN: 02 REPEATER:[OFF] PERIOD: 001
RX CHN: 01 DEST ADR: 0002  SLOT: 001.
```



Note – You should be familiar with the operation of the Clarion JX-1100 radio/modem before using it with the Series 7400 receivers.

4. Use the field descriptions in Table 2-27 as a guide while configuring the radio parameters.

Table 2-27 JX-1100 SETUP Fields

Field	Description
PORT	Assigns the receiver serial port (PORT) connected to the Clarion JX-1100 radio/modem, ports 1–4.
Enable	Switches JX-1100 support ON or OFF for the specified port.
LOC ADR	Assigns the Local Address for the JX-1100 radio/modem connected to the receiver. The Local Address is used to setup a network of JX-1100 nodes, each with a unique address. The value can be any number in the range of 1–255. The Local Address is sent by the JX-1100 with each data packet, identifying the source of each data packet.
NETWORK	Configures position reports for multiple rovers on the same channel. The JX-1100 Radio/Modem supports Time-Division, Multiple Access networking. Each rover can be configured to report back data, such as position, at a specified PERIOD and within a time-slice SLOT.
TX CHAN	Assigns the channel used by the radio when broadcasting data. It may range from 0–62. Only radios using the selected channel receive data transmitted from the reference station.
REPEATER	Configures the number of data packets routed through one radio repeater. The repeater is either OFF or is set to a values ranging from 1–8.
PERIOD	Defines the number of seconds elapsing between reports sent by a rover. The value can range from 1–120 seconds. Selecting a period of 1 second provides 5 SLOTS for reporting. If the PERIOD is set to 2 seconds, 10 slots are available. Each slot is 100 milliseconds long, irrespective of the PERIOD.

Table 2-27 JX-1100 SETUP Fields (Continued)

Field	Description
RX CHAN	Assigns a JX-1100 channel for receiving data. Set the RX CHN on the rover to the same channel as the TX CHN on the reference station. The number of channels ranges from 0–62.
DEST ADR	Assigns a JX-1100 destination address for data sent by the rover. Refers to the JX-1100 address at a remote tracking station.



Note – A radio may define up to 8 separate repeater channels which refer to 8 of the 63 available data channels supported by the JX-1100 radio.

3 NMEA-0183 Output

This chapter describes the formats of the subset of NMEA-0183 messages available for output by the MS Series receiver. Interested readers are directed to the following National Marine Electronics Association web site address to order the NMEA-0183 Standard:

<http://www.nmea.org>

3.1 NMEA-0183 Outputs

When NMEA-0183 output is enabled, a subset of NMEA-0183 messages can be output to external instruments and equipment interfaced to the MS Series serial ports. These NMEA-0183 messages allow external devices to use selected data collected or computed by the MS Series receiver.

All messages conform to the NMEA-0183 Version 2.30 format. All begin with \$ and end with a carriage return and a line feed. Data fields follow comma (,) delimiters and are variable in length. Null fields still follow a comma (,) delimiter but contain no information.

An asterisk (*) delimiter and checksum value follow the last field of data contained in a NMEA-0183 message. The checksum is the 8-bit exclusive OR of all characters in the message, including the commas, between each field, but not including the \$ and asterisk delimiters. The hexadecimal result is converted to two ASCII characters (0-9, A-F). The most significant character appears first.

Table 3-1 summarizes the set of NMEA messages supported by the MS Series receiver and shows the page number where detailed information about each message is found.

Table 3-1 NMEA Message Summary

Message	Function	Page
AVR	Time, yaw, tilt, range, mode, PDOP, number of SVs for Moving Baseline RTK	3-5
GGA	Time, position, and fix related data	3-6
GST	Position error statistics	3-8
GSV	Number of SVs in view, PRN, Elevation, azimuth, and SNR	3-9
PTNL,GGK	Time, position, position type and DOP values	3-10
PTNL,GGK_SYNC	Time, Synchronized position, position type and DOP values	3-12
PTNL,PJK	Local coordinate position output	3-14
PTNL,PJT	Projection type	3-15
PTNL,VGK	Time, locator vector, type and DOP values	3-16
PTNL,VHD	Heading Information	3-17
VTG	Actual track made good and speed over ground	3-18
ZDA	UTC day, month, and year, and local time zone offset	3-19

The output of individual NMEA messages can be enabled or disabled by selecting the specific messages using the front panel display or by using configuration toolbox to select an existing application file with a user-defined selection of enabled messages or by uploading an application file (with an Output Message Record) to overwrite the current NMEA message selection.

3.2 Common Message Elements

Each message contains:

- A message ID consisting of *\$GP* followed by the message type. For example, the message ID of the GGA message is *\$GPGGA*.
- A comma
- A number of fields that depend on message type, separated by commas
- An asterisk
- A checksum

Here is an example of a simple message with a message ID (*\$GPGGA*), followed by 13 fields and checksum value:

```
$GPGGA,172814.0,3723.46587704,N,12202.2695  
7864,W,2,6,1.2,18.893,M,-  
25.669,M,2.0,0031*4F
```

3.2.1 Message Values

Latitude and Longitude

latitude is represented as *ddmm.mmmm* and longitude is represented as *dddmm.mmmm*, where

- *dd* or *ddd* is degrees
- *mm.mmmm* is minutes and decimal fractions of minutes

Direction

Direction; north, south, east, west; is represented by a single character: *N*, *S*, *E*, or *W*.

Time

Time values are presented in Universal Time Coordinated (UTC) and are represented as *hhmmss.cc*, where:

- *hh* is hours, from 00–23
- *mm* is minutes
- *ss* is seconds
- *cc* is hundredths of seconds

3.3 NMEA Messages

When the NMEA-0183 output is enabled, the following messages can be produced to aid integration with other sensors.

AVR**Time, Yaw, Tilt, Range for Moving Baseline RTK**

The AVR message string is shown below, and Table 3-2 describes the message fields.

```
$PTNL,AVR,181059.6,+149.4688,Yaw,+0.0134,Tilt,,,60.191,3,2.5,6*00
```

Table 3-2 AVR Message Fields

Field	Meaning
1	UTC of vector fix
2	Yaw angle in degrees
3	Yaw
4	Tilt angle in degrees
5	Tilt
6	Reserved
7	Reserved
8	Range in meters
9	Quality indicator: 0: Fix not available or invalid 1: Autonomous GPS fix 2: Differential carrier phase solution RTK (Float) 3: Differential carrier phase solution RTK (Fix) 4: Differential code-based solution, DGPS
10	PDOP
11	Number of satellites used in solution

GGA Time, Position, and Fix Related Data

The GGA message string is shown below, and Table 3-3 describes the message fields.

```
$GPGGA,172814.0,3723.46587704,N,12202.2695
7864,W,2,6,1.2,18.893,M,-
25.669,M,2.0,0031*4F
```

Table 3-3 GGA Message Fields

Field	Meaning
1	UTC of position fix
2	Latitude
3	Direction of latitude: N: North S: South
4	Longitude
5	Direction of longitude: E: East W: West
6	GPS Quality indicator: 0: Fix not valid 1: GPS fix 2: Differential GPS fix 4: Real Time Kinematic, fixed integers 5: Real Time Kinematic, float integers
7	Number of SVs in use, range from 00 to 12
8	HDOP
9	Antenna height, MSL reference
10	M: unit of measure for altitude is meters
11	Geoid separation
12	M: geoid separation is measured in meters

Table 3-3 GGA Message Fields (Continued)

Field	Meaning
13	Age of differential GPS data record, Type 1 or Type 9. Null field when DGPS is not used
14	Base station ID, ranging from 0000 to 1023. A null field when any reference station ID is selected and no corrections are received

GST Position Error Statistics

The GST message string is shown below, and Table 3-4 describes the message fields.

```
$GPGST,172814.0,0.006,0.023,0.020,273.6,0.023,0.020,0.031*6A
```

Table 3-4 GST Message Fields

Field	Meaning
1	UTC of position fix
2	RMS value of the pseudorange residuals (includes carrier phase residuals during periods of RTK(float) and RTK(fixed) processing)
3	Error ellipse semi-major axis 1 sigma error, in meters
4	Error ellipse semi-minor axis 1 sigma error, in meters
5	Error ellipse orientation, degrees from true north
6	Latitude 1 sigma error, in meters
7	Longitude 1 sigma error, in meters
8	Height 1 sigma error, in meters

GSV **Satellite Information**

The GSV message string identifies the number of SVs in view, the PRN numbers, elevations, azimuths, and SNR values. The GSV message string is shown below, and Table 3-5 describes the message fields.

```
$GPGSV,4,1,13,02,02,213,,03,-3,000,,11,00,
121,,14,13,172,05*67
```

Table 3-5 GSV Message Fields

Field	Meaning
1	Total number of messages of this type in this cycle
2	Message number
3	Total number of SVs visible
4	SV PRN number
5	Elevation, in degrees, 90½ maximum
6	Azimuth, degrees from True North, 000½ to 359½
7	SNR, 00-99 dB (null when not tracking)
8-11	Information about second SV, same format as fields 4-7
12-15	Information about third SV, same format as fields 4-7
16-19	Information about fourth SV, same format as fields 4-7

PTNL,GGK Time, Position, Position Type, DOP

The PTNL,GGK message string is shown below, and Table 3-6 describes the message fields.

```
$PTNL,GGK,172814.00,071296,3723.46587704,N
,12202.26957864,W,3,06,1.7,EHT-6.777,M*48
```

Table 3-6 PTNL,GGK Message Fields

Field	Meaning
1	UTC of position fix
2	Date
3	Latitude
4	Direction of latitude: N: North S: South
5	Longitude
6	Direction of Longitude: E: East W: West
7	GPS Quality indicator: 0: Fix not available or invalid 1: Autonomous GPS fix 2: Differential, floating carrier phase integer-based solution, RTK(float) 3: Differential, fixed carrier phase integer-based solution, RTK(fixed) 4: Differential, code phase only solution (DGPS)
8	Number of satellites in fix
9	DOP of fix
10	Ellipsoidal height of fix
11	M: ellipsoidal height is measured in meters



Note – The PTNL,GGK message is longer than the NMEA-0183 standard of 80 characters.

PTNL, GGK_SYNC Time, Synchronized Position, Position Type, DOP

The PTNL,GGK_SYNC message has the same format as the PTNL,GGK message, but outputs Synchronized 1 Hz positions even in Low Latency mode. The PTNL,GGK_SYNC message string is shown below, and Table 3-7 describes the message fields.

```
$PTNL,GGK_SYNC,172814.00,071296,3723.46587
704,N,12202.26957864,W,3,06,1.7,EHT-
6.777,M*48
```

Table 3-7 PTNL,GGK_SYNC Message Fields

Field	Meaning
1	UTC of position fix
2	Date
3	Latitude
4	Direction of latitude: N: North S: South
5	Longitude
6	Direction of Longitude: E: East W: West
7	GPS Quality indicator: 0: Fix not available or invalid 1: Autonomous GPS fix 2: Differential, floating carrier phase integer-based solution, RTK(float) 3: Differential, fixed carrier phase integer-based solution, RTK(fixed) 4: Differential, code phase only solution (DGPS)
8	Number of satellites in fix
9	DOP of fix

Table 3-7 PTNL,GGK_SYNC Message Fields

Field	Meaning
10	Ellipsoidal height of fix
11	M: ellipsoidal height is measured in meters



Note – The PTNL,GGK_SYNC message is longer than the NMEA-0183 standard of 80 characters.

PTNL,PJK Local Coordinate Position Output

The PTNL,PJK message string is shown below, and Table 3-8 describes the message fields.

```
$PTNL,PJK,010717.00,081796,+732646.511,N,+
1731051.091,E,1,05,2.7,EHT-28.345,M*7C
```

Table 3-8 PTNL,PJK Message Fields

Field	Meaning
1	UTC of position fix
2	Date
3	Northing, in meters
4	Direction of Northing will always be N (North)
5	Easting, in meters
6	Direction of Easting will always be E (East)
7	GPS Quality indicator: 0: Fix not available or invalid 1: Autonomous GPS fix 2: Differential, floating carrier phase integer-based solution, RTK(float) 3: Differential, fixed carrier integer-based solution, RTK(fixed) 4: Differential, code phase only solution (DGPS)
8	Number of satellites in fix
9	DOP of fix
10	Ellipsoidal height of fix
11	M: ellipsoidal height is measured in meters



Note – The PTNL,PJK message is longer than the NMEA-0183 standard of 80 characters.

PTNL,PJT Projection Type

The PTNL,PJT message string is shown below, and Table 3-9 describes the message fields.

```
$PTNL,PJT,NAD83(Conus),California Zone 4  
0404,*51
```

Table 3-9 PTNL,PJT Message Fields

Field	Meaning
1	Coordinate system name (can include multiple words)
2	Projection name (can include multiple coordinates)

PTNL,VGK Vector Information

The PTNL,VGK message string is shown below, and Table 3-10 describes the message fields.

```
$PTNL,VGK,160159.00,010997,-0000.161,
00009.985,-0000.002,3,07,1,4,M*0B
```

Table 3-10 PTNL,VGK Message Fields

Field	Meaning
1	UTC of vector in hhmmss.ss format
2	Date in mmddy format
3	East component of vector, in meters
4	North component of vector, in meters
5	Up component of vector, in meters
6	GPS quality indicator: 0: Fix not available or invalid 1: Autonomous GPS fix 2: Differential carrier phase solution RTK(float) 3: Differential carrier phase solution RTK(fix) 4: Differential code-based solution, DGPS
7	Number of satellite if fix solution
8	DOP of fix
9	M: Vector components are in meters

PTNL,VHD Heading Information

The PTNL,VHD message string is shown below, and Table 3-11 describes the message fields.

```
$PTNL,VHD,030556.00,093098,187.718,
-22.138,-76.929,-5.015,0.033,0.006,
3,07,2.4,M*22
```

Table 3-11 PTNL,VHD Message Fields

Field	Meaning
1	UTC of position, in <i>hhmmss.ss,ddmmyy</i> format
2	Azimuth
3	Δ Azimuth/ Δ Time
4	Vertical Angle
5	Δ Vertical/ Δ Time
6	Range
7	Δ Range/ Δ Time
8	Quality indicator: 0: Fix not available or invalid 1: Autonomous GPS fix 2: Differential carrier phase solution RTK(float) 3: Differential carrier phase solution RTK(fix) 4: Differential code-based solution, DGPS
9	Number of satellites used in solution
10	PDOP

VTG **Actual Track Made Good Over and Speed Over Ground**

The VTG message string is shown below, and Table 3-12 describes the message fields.

```
$GPVTG,,T,,M,0.00,N,0.00,K*4E
```

Table 3-12 VTG Message Fields

Field	Meaning
1	Track made good (degrees true)
2	T: track made good is relative to true north
3	Null field
4	M: fixed text
5	Speed, in knots
6	N: speed is measured in knots
7	Speed over ground in kilometers/hour (KPH)
8	K: speed over ground is measured in KPH

ZDA UTC Day, Month, And Year, and Local Time Zone Offset

The ZDA message string is shown below, and Table 3-13 describes the message fields.

```
$GPZDA,172809,12,07,1996,00,00*45
```

Table 3-13 ZDA Message Fields

Field	Meaning
1	UTC
2	Day, ranging between 01 to 31
3	Month, ranging between 01 to 12
4	Year
5	Local time zone offset from GMT, ranging from 00 to ±13 hours
6	Local time zone offset from, in minutes

Fields 5 and 6, together, yield the total offset. For example, if field 5 is -5 and field 6 is -15, local time is 5 hours and 15 minutes earlier than GMT.

4 RS-232 Serial Interface Specification

The RS-232 Serial Interface Specification enables a remote computing device to communicate with an MS Series receiver over a RS-232 connection, using Data Collector Format packets. The RS-232 Serial Interface Specification provides command packets for configuring the MS Series receiver for operation, and report packets for retrieving position and status information from the receiver.

Data Collector Format packets are similar to the data collector format packets which evolved with the Trimble Series 4000 receivers. The set of Data Collector Format command and report packets implemented on the MS Series receiver are simplified with a more flexible method for scheduling the output of data. For a detailed explanation of the streamed data output format, see Report Packet 40h, GENOUT, page 6-8.

The MS Series receiver is configured for operation using application files. Application files include fields for setting all receiver parameters and functions. The default application file for the receiver includes the factory default values. Multiple application files can be uploaded to the receiver for selection with command packets. Application files for specific applications can be developed on one receiver and downloaded to a computer for transfer to other MS Series receivers.

For a general description of application files, see Application Files, page 4-13. For information about the structure of application files, see Report Packet 64h, APPFILE, page 6-59.

4.1 Communications Format

Supported data rates are: 2400, 4800, 9600, 19200, 38400, and 57600 baud. Any of these data rates can be used, however only 4800 baud or higher should be used. For example, a 20 Hz GGK string output requires the baud rate to be set to at least 19200. Only an 8-bit word format is supported, with Odd, Even or No parity, and 1 stop bit. The default communications format for the MS Series receiver is 9600 baud, 8 data bits, No parity, and 1 stop bit.

Changes to the serial format parameter settings for all serial ports are stored in EEPROM (Electrically-Erasable Read-Only Memory) and remain in effect across power cycles until you change the parameter settings.

4.1.1 Testing the Communications Link

To determine whether the MS Series receiver can accept RS-232 commands, the protocol request ENQ (05h) is used. The response is either ACK (06h) or NAK (15h).

ENQ/ACK/NAK correspond to Are you ready?, I am ready, and I am not ready. This quick 1-byte test can be sent by the remote device before any other command to make sure the RS-232 line is clear and operational.

4.1.2 Communication Errors

The receiver normally responds to a RS-232 Serial Interface Specification command packet within 500 milliseconds. If the receiver does not respond to the request or command, the external device can send numerous \0 characters (250) to cancel any partially received message before resending the previous message.

4.2 Data Collector Format Packets

Command packets are sent from the remote device to the MS Series receiver when requesting data, sending commands, or when managing application files. The MS Series receiver acknowledges every command packet sent by the remote device by sending an associated report packet or by acknowledging the transaction with an ACK (06h) or NAK (15h) from the receiver.



Note – The return of a NAK sometimes means that the receiver can not fulfill the request. That is, the requested command is not supported.

Packets are processed by the receiver on a first-in, first-out (FIFO) basis. External devices can send multiple packets without waiting for a response from each packet. The external device is responsible for matching expected responses with the actual response sent by the receiver.

4.2.1 Data Collector Format Packet Structure

Every command and report packet, regardless of its source and except for protocol sequences, has the same format as shown in Table 4-1.

Table 4-1 Data Collector Format Packet Structure

Byte #	Message	Description
<i>Begin Packet Header</i>		
0	STX (02h)	Start transmission
1	STATUS	Receiver status code (see Table 4-2)
2	PACKET TYPE	Hexadecimal code assigned to the packet
3	LENGTH	Single byte # of data bytes, limits data to 255 bytes
<i>Begin Packet Data</i>		
4– <i>n</i>	DATA BYTES	From 0– <i>n</i> length bytes
<i>Begin Packet Trailer</i>		
Length + 4	CHECKSUM	(status + type + length + data bytes) modulo 256
Length + 5	ETX (03h)	End transmission

Each message begins with a 4-byte header, followed by the bytes of data in the packet, and the packet ends with a 2 byte trailer. Byte 3 is set to 0 (00h) when the packet contains no data. Most data is transmitted between the receiver and remote device in binary format.

4.2.2 Data Collector Format Packet Functions

The functions of Data Collector Format command and report packets can be divided into the following categories:

- Information requests (command packets) and replies (report packets)
- Control functions (command packets) and RS-232 acknowledgments (ACK or NAK)
- Application file management

Requests for information, such as the Command Packet 4Ah (GETOPT), can be sent at any time. The expected reply (Report Packet 4Bh, RETOPT) is always sent. Some control functions may result in an RS-232 acknowledgment of NAK (15h) if one of the following conditions exists:

- The request is not supported (invalid) by the receiver (for example, a required option may not be installed on the receiver).
- The receiver cannot process the request.



Warning – Virtually no range checking is performed by the MS Series receiver on the values supplied by the remote device. The remote device must adhere to the exact ranges specified within this document. FAILURE TO DO SO MAY RESULT IN A RECEIVER CRASH AND/OR LOSS OF DATA.

4.2.3 The Receiver STATUS Byte

The status byte contains important indicators that usually require immediate attention by the remote device. The MS Series receiver never makes a request of the remote device. Each bit of the status byte identifies a particular problem. More than one problem may be indicated by the status byte. Table 4-2 lists the status byte codes.

Table 4-2 Status Byte Codes

Bit	Bit Value	Meaning
Bit 0	1	Reserved
Bit 1	1	Low Battery
Bit 2–7	0–63	Reserved

4.3 Reading Binary Values

The MS Series receiver stores numbers in Motorola format. The byte order of these numbers is the opposite of what personal computers (PCs) expect (Intel format). To supply or interpret binary numbers (8-byte DOUBLES, 4-byte LONGS and 2-byte INTEGERS), the byte order of these values must be reversed. A detailed description of the Motorola format used to store numbers in the MS Series receiver is provided in the following sections.

4.3.1 INTEGER Data Types

The INTEGER data types (CHAR, SHORT, and LONG) can be signed or unsigned. They are unsigned by default. All integer data types use two's complement representation. Table 4-3 lists the integer data types.

Table 4-3 Integer Data Types

Type	# of Bits	Range of Values (Signed)	(Unsigned)
CHAR	8	-128 to 127	0 to 255
SHORT	16	-32768 to 32767	0 to 65535
LONG	32	-2147483648 to 2147483647	0 to 4294967295

FLOATING-POINT Data Types

Floating-point data types are stored in the IEEE SINGLE and DOUBLE precision formats. Both formats have a sign bit field, an exponent field, and a fraction field. The fields represent floating-point numbers in the following manner:

$$\text{Floating-Point Number} = \langle \text{sign} \rangle 1. \langle \text{fraction field} \rangle \times 2^{(\langle \text{exponent field} \rangle - \text{bias})}$$

Sign Bit Field. The sign bit field is the most significant bit of the floating-point number. The sign bit is 0 for positive numbers and 1 for negative numbers.

Fraction Field. The fraction field contains the fractional part of a normalized number. Normalized numbers are greater than or equal to 1 and less than 2. Since all normalized numbers are of the form 1.XXXXXXXXX, the 1 becomes implicit and is not stored in memory. The bits in the fraction field are the bits to the right of the binary point, and they represent negative powers of 2. For example:

$$0.011 \text{ (binary)} = 2^{-2} + 2^{-3} = 0.25 + 0.125 = 0.375$$

Exponent Field. The exponent field contains a biased exponent; that is, a constant bias is subtracted from the number in the exponent field to yield the actual exponent. (The bias makes negative exponents possible.)

If both the exponent field and the fraction field are zero, the floating-point number is zero.

NaN. A NaN (Not a Number) is a special value which is used when the result of an operation is undefined. For example, adding positive infinity to negative infinity results in a NaN.

FLOAT Data Type

The FLOAT data type is stored in the IEEE single-precision format which is 32 bits long. The most significant bit is the sign bit, the next 8 most significant bits are the exponent field, and the remaining 23 bits are the fraction field. The bias of the exponent is 127. The range of single-precision format values is from 1.18×10^{-38} to 3.4×10^{38} . The floating-point number is precise to 6 decimal digits.

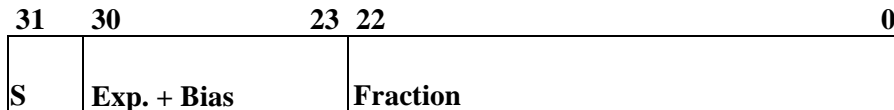

```

0 000 0000 0 000 0000 0000 0000 0000 0000 =
0.0
0 011 1111 1 000 0000 0000 0000 0000 0000 =
1.0
1 011 1111 1 011 0000 0000 0000 0000 0000 =
-1.375
1 111 1111 1 111 1111 1111 1111 1111 1111 =
NaN

```

DOUBLE

The DOUBLE data type is stored in the IEEE double-precision format which is 64 bits long. The most significant bit is the sign bit, the next 11 most significant bits are the exponent field, and the remaining 52 bits are the fractional field. The bias of the exponent is 1023. The range of single precision format values is from 2.23×10^{-308} to 1.8×10^{308} . The floating-point number is precise to 15 decimal digits.

63	62	52	51	0
S	Exp. + Bias		Fraction	

```

0 000 0000 0000 0000 0000 ... 0000 0000
0000 = 0.0
0 011 1111 1111 0000 0000 ... 0000 0000
0000 = 1.0
1 011 1111 1110 0110 0000 ... 0000 0000
0000 = -0.6875
1 111 1111 1111 1111 1111 ... 1111 1111
1111 = NaN

```

4.4 Data Collector Format Packet Summary

Detailed descriptions of the Data Collector Format are provided in Chapter 5, Data Collector Format Command Packets and Chapter 6, Data Collector Format Report Packets. Table 4-4 summarizes the Data Collector Format command and report packets, and shows the location in this manual where detailed information about the packet is found.

Table 4-4 Data Collector Format Packet Summary

ID	Name	Function	Page
06h	Command Packet 06h, GETSERIAL	Receiver and Antenna Information Request	5-3
07h	Report Packet 07h, RSERIAL	Receiver and Antenna Information Report	6-3
08h	Command Packet 08h, GETSTAT1	Receiver Status Request	5-4
09h	Report Packet 09h, RECSTAT1	Receiver Status Report	6-5
40h	Report Packet 40h, GENOUT	General Output Record Reports	6-8
4Ah	Command Packet 4Ah, GETOPT	Receiver Options Request	5-5
4Bh	Report Packet 4Bh, RETOPT	Receiver Options Parameters Report	6-28
54h	Command Packet 54h, GETSVDATA	Satellite Information Request	5-6
55h	Report Packet 55h, RETSVDATA	Satellite Information Reports	6-33
56h	Command Packet 56h, GETRAW	Position or Real-Time Survey Data Request	5-8
57h	Report Packet 57h, RAWDATA	Position or Real-Time Survey Data Report	6-43
64h	Command Packet 64h, APPPFILE	Application File Record Command	5-10

Table 4-4 Data Collector Format Packet Summary

ID	Name	Function	Page
64h	Report Packet 64h, APPFILE	Application File Record Report	6-59
65h	Command Packet 65h, GETAPPFILE	Application File Request	5-36
66h	Command Packet 66h, GETAFDIR	Application File Directory Listing Request	5-38
67h	Report Packet 67h, RETAFDIR	Directory Listing Report	6-60
68h	Command Packet 68h, DELAPPFILE	Delete Application File Data Command	5-39
6Dh	Command Packet 6Dh, ACTAPPFILE	Activate Application File	5-40
6Eh	Report Packet 6Eh, BREAKRET	Break Sequence Return	6-64
81h	Command Packet 81h, KEYSIM	Key Simulator	5-41
82h	Command Packet 82h, SCRDUMP	Screen Dump Request	5-43
82h	Report Packet 82h, SCRDUMP	Screen Dump	6-70

4.5 Application Files

The software tools included with the MS Series receiver include software for creating application files and uploading the files to the receiver.

The external device can transfer application files to the receiver using the Configuration Toolbox software (CTOOLBOX) or by creating the application files with a custom software program.

Application files contain a collection of individual records that fully prescribe the operation of the receiver. Application files are transferred using the standard Data Collector Format packet format.

Each application file can be tailored to meet the requirements of separate and unique applications. Up to 10 application files can be stored within the receiver for activation at a later date.

There are three very important application files in the MS Series receiver. These are explained in Table 4-5.

Table 4-5 Important Application Files and Their Functionality

Name	Function
DEFAULT	Permanently stored application file containing the receiver's factory default settings. This application file is used when the receiver is reset to the factory default settings.
CURRENT	Holds the MS Series receiver's current settings.
POWER_UP	Any user-defined application file that is named POWER_UP will be invoked every time the receiver is powered on.

Individual records within an existing application file can be updated using the software tools included with the receiver. For example, the OUTPUT MESSAGES Record in an application file can be updated without affecting the parameter settings in other application file records.

Application files can be started immediately and/or the files can be stored for later use.

Once applications files are uploaded into memory, command packets can be used to manage the files. Command packets are available for downloading application files, selecting application files, and deleting application files.

4.5.1 Application File Records

Application files can include the following records:

- File Storage Record
- General Controls Record
- Serial Port Baud/Format Record
- Reference Node Record
- SV Enable/Disable Record
- Output Message Record
- Antenna Record
- Device Control Record
- Static/Kinematic Record
- Input Message Record
- Coordinate System

4.5.2 Application File Record Format

The application record data is in the Motorola format described in Reading Binary Values, page 4-7. If any part of the application record data is invalid, then the receiver ignores the entire record. The receiver reads a record using the embedded length. Any extraneous data is ignored. This allows for backward compatibility when the record length is increased to add new functions. If the user is concerned about application files producing the same results on future receivers, then provisions should be made to assure that the application records do not contain extraneous data. Table 4-6 describes the application file records.

Table 4-6 Application File Record s

Record	Description
FILE STORAGE RECORD	When present, this record forces the application file to be stored in the receiver's database/file system. When included in an application file, the file storage record must be the first record in the application file.
GENERAL CONTROLS RECORD	The General Controls Record is used to set general GPS operating parameters for the receiver, including the Elevation Mask, Frequency Rate, PDOP (Position Dilution of Precision) Mask, and Frequency Source.
SERIAL PORT BAUD/FORMAT RECORD	The Serial Port Baud Rate/Format Record is used to set the communication parameters for a selected serial port. The selected serial port is determined by the Serial Port Index (Byte 2), a number ranging from 0 (zero) to 3 (three).
REFERENCE NODE RECORD	Provides LLA (Latitude, Longitude, Altitude) coordinates when the receiver is used as a base or reference station.

Table 4-6 Application File Records (Continued)

Record	Description
SV ENABLE/ DISABLE RECORD	The SV Enable/Disable Record is used to enable or disable a selection of the 32 GPS satellites, regardless of whether the satellites are in good health or not. By default, the receiver is configured to use all satellites which are in good health. This record is useful for enabling satellites which are not in good health. Once enabled, the health condition of the satellite(s) is ignored, and the GPS signal transmissions from the satellite(s) are considered when computing position solutions.
OUTPUT MESSAGE RECORD	The Output Message Record selects the output protocol supported by a specified serial port, the frequency of message transmissions, the integer second offset from the scheduled output rate, and output specific flags.
ANTENNA RECORD	The Antenna Record identifies the height of the base station (reference station) antenna.
DEVICE CONTROL RECORD	The number of bytes contained in the record and the length of the record are determined by the Device Type (Byte 2).
STATIC/ KINEMATIC RECORD	Determines whether the receiver is configured to perform Static or Kinematic surveys.
INPUT MESSAGE RECORD	Selects the type of GPS correction, serial port, message origin, and input specific settings.

For detailed information about the structure of application files and application file records, see Report Packet 64h, APPFILE, page 6-59.

For information about selecting application files once they are uploaded to the receiver, see Command Packet 6Dh, ACTAPPPFILE, page 5-40. For information about deleting application files stored in computer memory, see Command Packet 68h, DELAPPPFILE, page 5-39. For information about downloading an application file from the receiver, see Command Packet 64h, APPFILE, page 5-10.

For information about requesting a listing of the application files stored on the receiver, see Command Packet 66h, GETAFDIR, page 5-38 and Report Packet 67h, RETAFDIR, page 6-60.

The parameter settings in the Output Messages Record of an application file determine which output messages are streamed to the remote device. For more information, see Report Packet 40h, GENOUT, page 6-8.

5 Data Collector Format Command Packets

Data Collector Format command packets are sent from the remote device to the receiver to execute receiver commands or to request data reports. The receiver acknowledges all command packets, by sending a corresponding report packet or by acknowledging the completion of an action.

5.1 Command Packet Summary

The following sections provide details for each command and report packet. Table 5-1 provides a summary of the command packets.

Table 5-1 Command Packet Summary

ID	Command Packet	Action	Page
06h	Command Packet 06h, GETSERIAL	Receiver and Antenna Information Request	5-3
08h	Command Packet 08h, GETSTAT1	Receiver Status Request	5-4
4Ah	Command Packet 4Ah, GETOPT	Receiver Options Request	5-5
54h	Command Packet 54h, GETSVDATA	Satellite Information Request	5-6
56h	Command Packet 56h, GETRAW	Position or Real-Time Survey Data Request	5-8
64h	Command Packet 64h, APPFILE	Application File Record Command	5-10
65h	Command Packet 65h, GETAPPFILE	Application File Request	5-10
66h	Command Packet 66h, GETAFDIR	Application File Directory Listing Request	5-38
68h	Command Packet 68h, DELAPPFILE	Delete Application File Data Command	5-39
6Dh	Command Packet 6Dh, ACTAPPFILE	Activate Application File	5-40
81h	Command Packet 81h, KEYSIM	Key Simulator	5-41
82h	Command Packet 82h, SCR_DUMP	Screen Dump Request	5-43

06h

Command Packet 06h, GETSERIAL Receiver and Antenna Information Request

Command Packet 06h requests receiver and antenna information. The receiver responds by sending the data in the Report Packet 07h.

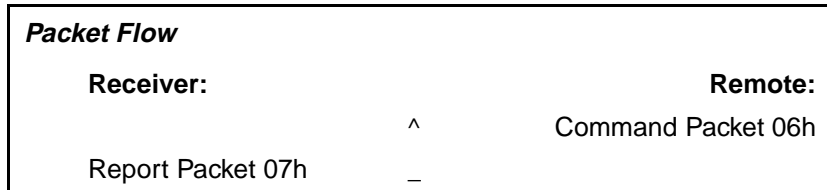

Table 5-2 describes the packet structure.

Table 5-2 Command Packet 06h Structure

Byte #	Item	Type	Value	Meaning
0	STX	CHAR	02h	Start transmission
1	STATUS	CHAR	Table 4-2	Receiver status code
2	PACKET TYPE	CHAR	06h	Command Packet 06h
3	LENGTH	CHAR	00h	Data byte count
4	CHECKSUM	CHAR	Table 4-1	Checksum value
5	ETX	CHAR	03h	End transmission

08h

Command Packet 08h, GETSTAT1 Receiver Status Request

Command Packet 08h requests receiver status information regarding position determination, the number of tracked satellites, battery capacity remaining, the remaining memory. The receiver responds by sending the data in Report Packet 09h.

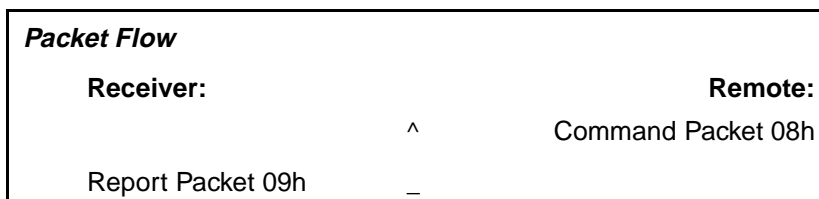

Table 5-3 describes the packet structure. for additional information, see Report Packet 09h, RECSTAT1, page 6-5.

Table 5-3 Report Packet 08h Structure

Byte #	Item	Type	Value	Meaning
0	STX	CHAR	02h	Start transmission
1	STATUS	CHAR	Table 4-2	Receiver status code
2	PACKET TYPE	CHAR	08h	Command Packet 08h
3	LENGTH	CHAR	00h	Data byte count
4	CHECKSUM	CHAR	Table 4-1	Checksum value
5	ETX	CHAR	03h	End transmission

The current antenna parameter settings can be checked by sending Command Packet 06h to request Report Packet 07h. For more information, see Command Packet 06h, GETSERIAL, page 5-3 and Report Packet 07h, RSERIAL, page 6-3.

4Ah Command Packet 4Ah, GETOPT Receiver Options Request

Command Packet 4Ah requests the list of receiver options installed on the receiver. The receiver responds by sending the data in Report Packet 4Bh. Table 5-4 describes the packet structure. For additional information, see Report Packet 4Bh, RETOPT, page 6-28.

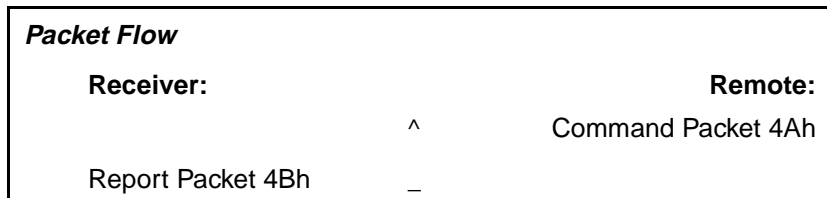

Table 5-4 Command Packet 4Ah Structure

Byte #	Item	Type	Value	Meaning
0	STX	CHAR	02h	Start transmission
1	STATUS	CHAR	Table 4-2	Receiver status code
2	PACKET TYPE	CHAR	4Ah	Command Packet 4Ah
3	LENGTH	CHAR	00h	Data byte count
4	CHECKSUM	CHAR	Table 4-1	Checksum value
5	ETX	CHAR	03h	End transmission

54h

Command Packet 54h, GETSVDATA Satellite Information Request

Command Packet 54h requests satellite information. Request may be for an array of flags showing the availability of satellite information such as an ephemeris or almanac. In addition, satellites may be enabled or disabled with this command packet. Table 5-5 shows the packet structure. For additional information, see Report Packet 4Bh, RETOPT, page 6-28.

Packet Flow

Receiver:	^	Remote:
Report Packet 55h or NAK	_	Command Packet 54h



Note – The normal reply to Command Packet 54h is usually Report Packet 55h. However, a NAK is returned if the SV PRN is out of range (except for SV FLAGS), if the DATA SWITCH parameter is out of range, or if the requested data is not available for the designated SV.

Table 5-5 Command Packet 54h Structure

Byte #	Item	Type	Value	Meaning
0	STX	CHAR	02h	Start transmission
1	STATUS	CHAR	Table 4-2	Receiver status code
2	PACKET TYPE	CHAR	54h	Command Packet 54h
3	LENGTH	CHAR	03h	Data byte count
4	DATA SWITCH	CHAR	Table 5-6	Selects type of satellite information downloaded from receiver or determines whether a satellite is enabled or disabled
5	SV PRN #	CHAR	01h–20h	Pseudorandom number (1–32) of satellite (ignored if SV Flags or ION/UTC is requested)
6	RESERVED	CHAR	00h	Reserved (set to zero)
7	CHECKSUM	CHAR	Table 4-2	Checksum value
8	ETX	CHAR	03h	End transmission

Table 5-6 DATA SWITCH Byte Values

Byte Value		Meaning
Dec	Hex	
0	00h	SV Flags indicating Tracking, Ephemeris and Almanac, Enable/Disable state
1	01h	Ephemeris
2	02h	Almanac
3	03h	ION/UTC data
4	04h	Disable Satellite
5	05h	Enable Satellite

† The Enable and Disable Satellite data switch values always result in the transmission of a RETSVDATA message as if the SV Flags are being requested.

56h

Command Packet 56h, GETRAW Position or Real-Time Survey Data Request

Command Packet 56h requests raw satellite data in *.DAT Record 17 format or Concise format. The request may specify if Real-Time attribute information is required. The receiver responds by sending the data in Report Packet 57h. Alternatively, the packet can be used to request receiver position information in *.DAT record 11 format. Table 5-7 describes the packet structure. For additional information, see Report Packet 57h, RAWDATA, page 6-43.

Packet Flow**Receiver:****Remote:**

^

Command Packet 56h

Report Packet 57h or NAK

_



Note – The reply to this command packet is usually a Report Packet 57h. A NAK is returned if the Real-Time Survey Data Option (RT17) is not installed on the receiver.

Table 5-7 Command Packet 56h Structure

Byte #	Item	Type	Value	Meaning
0	STX	CHAR	02h	Start transmission
1	STATUS	CHAR	Table 4-2	Receiver status code
2	PACKET TYPE	CHAR	56h	Command Packet 56h
3	LENGTH	CHAR	03h	Data byte count
4	TYPE RAW DATA	CHAR	Table 5-8	Identifies the requested type of raw data
5	FLAGS	CHAR	Table 5-9	Flag bits for requesting raw data
6	RESERVED	CHAR	00h	Reserved; set to zero
7-8	CHECKSUM	SHORT	Table 4-1	Checksum value
9	(03h) ETX	CHAR	03h	End Transmission

Table 5-8 TYPE RAW DATA Values

Byte Value		Meaning
Dec	Hex	
0	00h	Real-Time Survey Data Record (Record Type 17)
1	01h	Position Record (Record Type 11)

Table 5-9 FLAGS Bit Values

Bit	Meaning
0	Raw Data Format 0: Expanded *.DAT Record Type 17 format 1: Concise *.DAT Record Type 17 format
1	Enhanced Record with real-time flags and IODE information 0: Disabled – record data not enhanced 1: Enabled – record data is enhanced
2-7	Reserved (set to zero)

64h

Command Packet 64h, APPFILE Application File Record Command

Command Packet 64h is sent to create, replace, or report on an application file. The command packet requests the application file by System File Index.

<i>Packet Flow</i>	
Receiver:	Remote:
	^ Command Packet 64h
ACK	—

For detailed information, about MS Series Application Files and guidelines for using application files to control remote devices, see 07h, page 6-3.

Packet Paging

Since an application file contains a maximum of 2048 bytes (all records are optional) of data and exceeds the byte limit for RS-232 Serial Interface Specification packets, Command Packet 64h is divided into several subpackets called pages. The PAGE INDEX byte (byte 5) identifies the packet page number and the MAXIMUM PAGE INDEX byte (byte 6) indicates the maximum number of pages in the report.

The first and subsequent pages are filled with a maximum of 248 bytes consisting of 3 bytes of page information and 245 bytes of application file data. The application file data is split where ever the 245 byte boundary falls. Therefore the remote device sending the Command Packet pages must construct the application file using the 248 byte pages before sending the file to the receiver.

To prevent data mismatches, each report packet is assigned a Transmission Block Identifier (byte 4) which gives the report pages a unique identity in the data stream. The software on the remote device can identify the pages associated with the report and reassemble the application file using bytes 4–6.

Table 5-10 shows the structure of the report packet containing the application file.

Table 5-10 Command Packet 64h Structure

Byte #	Item	Type	Value	Meaning
0	STX	CHAR	02h	Start transmission
1	STATUS	CHAR	Table 4-2	Receiver status code
2	PACKET TYPE	CHAR	64h	Command Packet 64h
3	LENGTH	CHAR	Table 4-1	Data byte count
4	TX BLOCK IDENTIFIER	CHAR	00h–FFh	A Transmission Block Identifier, ranging between 0–255, that must remain the same for all pages of an application file transfer.
5	PAGE INDEX	CHAR	00h–FFh	Index number (0–255) assigned to the current page
6	MAXIMUM PAGE INDEX	CHAR	00h–FFh	Index number (0–255) assigned to the last page of the packet

Table 5-10 Command Packet 64h Structure (Continued)

Byte #	Item	Type	Value	Meaning
FILE CONTROL INFORMATION BLOCK				
The FILE INFORMATION CONTROL BLOCK must be sent in the first page of the report containing the application file. The second page and consecutive pages must not include a FILE CONTROL INFORMATION BLOCK.				
7	APPLICATION FILE SPECIFICATION VERSION	CHAR	03h	Always 3 for this version of the specification
8	DEVICE TYPE	CHAR	Table 5-11	Unique identifier for every receiver/device type that supports the application file interface
9	START APPLICATION FILE FLAG	CHAR	Table 5-12	Determines whether or not the application file is activated immediately after records are sent to receiver.
10	FACTORY SETTINGS FLAG	CHAR	Table 5-13	Determines whether or not the receiver is reset to factory default settings prior to activating the records in the application file.

Table 5-10 Command Packet 64h Structure (Continued)

Byte #	Item	Type	Value	Meaning
FILE STORAGE RECORD				
The FILE STORAGE RECORD indicates the application file creation date and time and provides identification information required to store the file in memory. When included in the application file, this record must be the first record within the file.				
0	RECORD TYPE	CHAR	00h	File Storage Record
1	RECORD LENGTH	CHAR	0Dh	Number of bytes in record, excluding bytes 0 and 1
2–9	APPLICATION FILE NAME	CHARs	<i>ASCII text</i> A...Z, a...z, _ (<i>underscore</i>)	Eight-character name for the application file
10	YEAR OF CREATION	CHAR	00h–FFh	Year when application file is created, ranging from 00–255 (1900 = 00) [†]
11	MONTH OF CREATION	CHAR	01h–0Ch	Month when application file is created (01–12) [†]
12	DAY OF CREATION	CHAR	00h–1Fh	Day of the month when application file is created (00–31) [†]
13	HOUR OF CREATION	CHAR	00h–17h	Hour of the day when application file is created (00–23) [†]
14	MINUTES OF CREATION	CHAR	00h–3Bh	Minutes of the hour when application file is created (00–59) [†]

Table 5-10 Command Packet 64h Structure (Continued)

Byte #	Item	Type	Value	Meaning
GENERAL CONTROLS RECORD				
The GENERAL CONTROLS RECORD sets general GPS operating parameters for the receiver, including the Elevation Mask, Measurement Rate, PDOP (Position Dilution of Precision) Mask, and the Positioning Mode.				
0	RECORD TYPE	CHAR	01h	General Controls Record
1	RECORD LENGTH	CHAR	08h	Number of bytes in record, excluding bytes 0 and 1
2	ELEVATION MASK	CHAR	00h–5Ah	Elevation Mask in degrees (0–90)
3	MEASUREMENT RATE	CHAR	Table 5-14	Frequency rate at which the receiver generates measurements
4	PDOP MASK	CHAR	00h–FFh	Position Dilution of Precision Mask (0–255)
5	RESERVED	CHAR	00h	Reserved (set to zero).
6	RESERVED	CHAR	00h	Reserved (set to zero).
7	RTK POSITIONING MODE	CHAR	Table 5-18	Sets the RTK positioning mode.
8	POSITIONING SOLUTION SELECTION	CHAR	Table 5-15	Controls use of DGPS and RTK solutions
9	RESERVED	CHAR	00h	Reserved (set to zero)

Table 5-10 Command Packet 64h Structure (Continued)

Byte #	Item	Type	Value	Meaning
SERIAL PORT BAUD/FORMAT RECORD				
The SERIAL PORT BAUD RATE/FORMAT RECORD is used to set the communication parameters for the serial ports. Individual serial ports are identified within the record by the SERIAL PORT INDEX number.				
0	RECORD TYPE	CHAR	02h	Serial Port Baud Rate/ Format Record
1	RECORD LENGTH	CHAR	04h	Number of bytes in the record, excluding bytes 0 and 1
2	SERIAL PORT INDEX.	CHAR	00h–03h	The number of the serial port to configure.
3	BAUD RATE	CHAR	Table 5-16	Data transmission rate
4	PARITY	CHAR	Table 5-17	Sets the parity of data transmitted through the port. The eight data bits and one stop bit are always used, regardless of the parity selection.
5	FLOW CONTROL	CHAR	Table 5-19	Flow control

Table 5-10 Command Packet 64h Structure (Continued)

Byte #	Item	Type	Value	Meaning
REFERENCE (BASE) NODE RECORD				
The REFERENCE NODE RECORD is an optional record for providing LLA (Latitude, Longitude, Altitude) coordinates for base station nodes.				
0	RECORD TYPE	CHAR	03h	Reference Node Record
1	RECORD LENGTH	CHAR	25h	Data bytes in the record, excluding bytes 0 and 1.
2	FLAG	CHAR	00h	Reserved (set to zero).
3	NODE INDEX	CHAR	00h	Reserved (set to zero).
4–11	NAME	CHAR	<i>ASCII text</i>	Eight-character reference node description
12–19	REFERENCE LATITUDE	DOUBLE	<i>radians</i>	Latitude of reference node, $\pm\pi/2$
20–27	REFERENCE LONGITUDE	DOUBLE	<i>radians</i>	Longitude of reference node, $\pm\pi$
28–35	REFERENCE ALTITUDE	DOUBLE	<i>meters</i>	Altitude of reference node, $-9999.999 \leq h \leq +9999.999$
36–37	STATION ID	SHORT	0000h–03FFh	Reference Node Station ID for RTCM output.
38	RTK STATION	CHAR	00h–1Fh	Reference Station ID for RTK output.

Table 5-10 Command Packet 64h Structure (Continued)

Byte #	Item	Type	Value	Meaning
SV ENABLE/DISABLE RECORD				
The SV ENABLE/DISABLE RECORD is used to enable or disable a selection of the 32 GPS satellites. By default, the receiver is configured to use all satellites which are in good health. This record is useful for enabling satellites which are not in good health. Once enabled, the health condition of the satellite(s) is ignored, and the GPS signal transmissions from the satellite(s) are considered when computing position solutions.				
0	RECORD TYPE	CHAR	06h	SV Enable/Disable Record
1	RECORD LENGTH	CHAR	20h	Number of bytes in record, excluding bytes 0 and 1
2–33	SV ENABLE/DISABLE STATES	CHARs	Table 5-20	Array of Enable/Disable flags for the 32 SVs. The first byte sets the desired Enable/Disable status of SV1, the second sets the status of SV2, etc.

Table 5-10 Command Packet 64h Structure (Continued)

Byte #	Item	Type	Value	Meaning
OUTPUT MESSAGE RECORD				
The OUTPUT MESSAGE RECORD selects the outputs for a specified serial port, the frequency of message transmissions, the integer second offset from the scheduled output rate, and output specific flags. Bytes 0 through 5 are included in all records, regardless of the output message type. The remaining bytes in the record (byte 6...) are dependent on the output message type.				
0	RECORD TYPE	CHAR	07h	Output Message Record
1	RECORD LENGTH	CHAR	04h, 05h or 06h	Number of bytes in the record, excluding bytes 0 and 1. The number of bytes is dependent on the number of output specific flags.
2	OUTPUT MESSAGE TYPE	CHAR	Table 5-21	Type of message or packet
3	PORT INDEX	CHAR	00h–03h	Serial port index number.
4	FREQUENCY	CHAR	Table 5-22	Frequency of message transmissions
5	OFFSET	CHAR	00h–FFh	Integer second offset (0–255 seconds) from scheduled output rate (Only valid when frequency, < 1 Hz or > 1 second).
OUTPUT MESSAGE RECORD TYPE 10 (GSOF)				
6	GS OF SUBMESSAGE TYPE	CHARs	Table 5-23	GSOF message number.
7	OFFSET	CHAR	0–255	Integer second offset from scheduled frequency

Table 5-10 Command Packet 64h Structure (Continued)

Byte #	Item	Type	Value	Meaning
OUTPUT MESSAGE RECORD TYPE 2 (RTK-CMR)				
6	CMR MESSAGE TYPE FLAGS	CHAR	Table 5-24	CMR message types
OUTPUT MESSAGE RECORD TYPE 3 (RTCM)				
6	RTCM FLAGS	CHAR	Table 5-26	Bit settings for RTCM output flags
OUTPUT MESSAGE RECORD TYPE 4 (RT17)				
6	REAL-TIME 17 MESSAGE FLAGS	CHAR	Table 5-25	RT17 (Real Time 17) Flags
ANTENNA RECORD				
The ANTENNA RECORD identifies the Antenna Type and the true vertical height of antenna above the ground mark.				
0	RECORD TYPE	CHAR	08h	Reference Node Record
1	RECORD LENGTH	CHAR	0Ch	Number of bytes in record, excluding bytes 0 and 1
2–9	ANTENNA HEIGHT	DOUBLE	<i>meters</i>	Vertical height of antenna, in meters
10–11	ANTENNA TYPE	SHORT	Table 5-27	Defines the type of antenna connected to the receiver
12	RESERVED	CHAR	00h	Reserved (set to zero)
13	RESERVED	CHAR	00h	Reserved (set to zero)

Table 5-10 Command Packet 64h Structure (Continued)

Byte #	Item	Type	Value	Meaning
DEVICE CONTROL RECORD				
The DEVICE CONTROL RECORD contains configuration parameters for controlling some external devices and the operation of some receiver options. The number of bytes contained in the record and the length of the record are determined by the DEVICE TYPE entry. The table subheadings identify different devices				
0	RECORD TYPE	CHAR	09h	Device Control Record
1	RECORD LENGTH	CHAR	02h or 0Dh	Number of bytes in record, excluding bytes 0 and 1.
2	DEVICE TYPE	CHAR	Table 5-28	Type of device
For 1 PPS Output Only				
3	1 PPS CONTROL	CHAR	Table 5-29	Enables or disables 1 PPS output byte 2 is set to 2

Table 5-10 Command Packet 64h Structure (Continued)

Byte #	Item	Type	Value	Meaning
For Clarion JX-10 Radio Only				
3	PORT	CHAR	00h–03h	Index number of serial port connected to Clarion JX-10 Radio.
4	JX-10 ENABLE FLAG	CHAR	Table 5-30	Enables or disables the Clarion JX-10 Radio when byte 2 is set to 6.
5	MODE	CHAR	Table 5-31	Sets the JX-10 Radio to operate as a rover radio or base station radio.
6	TRANSMIT CHANNEL	CHAR	00h–3Eh	The JX-10 Radio can be set to transmit data using one of 0–62 channels.
7	RECEIVE CHANNEL	CHAR	00h–3Eh	The JX-10 Radio can be set to receiver data on one of 0–62 channels.
8	LOCAL ADDRESS	CHAR	00–FFh	0–255
9	DESTINATION ADDRESS	CHAR	00–FFh	0–255
10	REPEATER	CHAR	Table 5-32	
11	PERIOD	CHAR	01h–78h	(1–120 seconds)
12–13	SLOT	CHAR		$1 \leq slot \leq 5 * period$
14	TIME DIVISION MULTIPLEXING	CHAR	Table 5-33	

Table 5-10 Command Packet 64h Structure (Continued)

Byte #	Item	Type	Value	Meaning
STATIC/KINEMATIC RECORD				
The bytes value in the STATIC/KINEMATIC RECORD determine whether the receiver is operating in Static or Kinematic mode.				
0	RECORD TYPE	CHAR	0Ah	Static/Kinematic Record
1	RECORD LENGTH	CHAR	01h	Number of bytes in record, excluding bytes 0 and 1
2	STATIC/KINEMATIC MODE	CHAR	Table 5-34	Configures receiver for static or kinematic operation
RTCM INPUT RECORD				
The bytes of the RTCM INPUT RECORD set the RTK/DGPS switch over range and identify the RTCM base station used for RTK/DGPS corrections.				
0	RECORD TYPE	CHAR	10h	RTCM Input Record
1	RECORD LENGTH	CHAR	06h	Number of bytes in record, excluding bytes 0 and 1.
2–5	RANGE	LONG	<i>meters</i>	RTK/DGPS automatic switch over range
6–7	STATION ID	SHORT		Station ID of the RTCM base station that is used for RTK/DGPS corrections. Valid station IDs range between 1–1023 (0000h–03FFh). If –1, 65535, or FFFFh is set, any station ID is used.
Length +4	CHECKSUM	CHAR	Table 4-1	Checksum value
Length +5	ETX	CHAR	03h	End transmission

Table 5-11 DEVICE TYPE Byte Values

Byte Value		Meaning
Dec	Hex	
0	00h	All Devices
1	01h	Series 7400 receiver
2-5	02h-05h	Reserved
6	06h	MS Series Receiver

Table 5-12 START APPLICATION FILE FLAG Byte Values

Byte Value		Meaning
Dec	Hex	
0	00h	Do NOT apply the application file parameter settings to the active set of parameters when the transfer is complete.
1	01h	Apply application file records immediately.

Table 5-13 FACTORY SETTINGS Byte Values

Byte Value		Meaning
Dec	Hex	
0	00h	Alter receiver parameters only as specified in the application file. Leave unspecified settings alone.
1	01h	Set all controls to factory settings prior to applying the application file.

Table 5-14 MEASUREMENT RATE Byte Values

Byte Value		Meaning
Dec	Hex	
0	00h	1 Hz
1	01h	5 Hz
2	02h	10 Hz

Table 5-15 Positioning Solution Selection Values

Byte Value		Meaning
Dec	Hex	
0	00	Use best available solution.
1	01	Produce DGPS and Autonomous solutions.
2	02	Produce DGPS, RTK Float and Autonomous solutions. On-the-fly RTK initialization is disabled, therefore no RTK Fix solutions are generated.
3	03	Produce RTK Fix, DGPS and Autonomous solutions (no RTK Float solutions).

Table 5-16 BAUD RATE Byte Values

Byte Value		Meaning
Dec	Hex	
0	00h	9600 baud (default)
1	01h	2400 baud
2	02h	4800 baud
3	03h	9600 baud
4	04h	19.2K baud
5	05h	38.4K baud
6	06h	57.6K baud
7	07h	115.2K baud

Table 5-17 PARITY Byte Values

Byte Value		Meaning
Dec	Hex	
0	00h	No Parity (10-bit format)
1	01h	Odd Parity (11-bit format)
2	02h	Even Parity (11-bit format)

Table 5-18 RTK POSITIONING MODE Byte Values

Byte Value		Meaning
Dec	Hex	
0	00h	Synchronous positioning
1	01h	Low Latency positioning

Table 5-19 FLOW CONTROL Byte Values

Byte Value		Meaning
Dec	Hex	
0	00h	None
1	01h	CTS

Table 5-20 SV ENABLE/DISABLE STATES Flag Values

Byte Value		Meaning
Dec	Hex	
0	00h	Default
1	01h	Disable the satellite
2	02h	Enable the satellite regardless of whether the satellite is in good or bad health

Table 5-21 OUTPUT MESSAGE TYPE Byte Values

Byte Value		Output Protocol
Dec	Hex	
0	00h	All Messages (Off on all ports)
1	01h	Reserved
2	02h	RTK Correction CMR Output
3	03h	RTCM Output
4	04h	Real-Time 17 Output
5	05h	Reserved
6	06h	NMEA - GGA Output
7	07h	NMEA - GGK Output
8	08h	NMEA - ZDA Output
9	09h	Reserved
10	0Ah	GSOF
11	0Bh	1 PPS (ASCII)
12	0Ch	NMEA - VTG Output
13	0Dh	NMEA - GST Output
14	0Eh	NMEA - PJK Output
15	0Fh	NMEA - PJT Output
16	10h	NMEA - VGK Output
17	11h	NMEA - VHD Output
18	12h	NMEA - GSV Output
19–254	13h–FEh	Reserved (future output protocols)
255	FFh	All messages off on the specified port.



Note – The number of supported output protocols could increase in the future

Table 5-22 FREQUENCY Byte Values

Byte Value		Meaning
Dec	Hex	
0	00h	Off
1	01h	10 Hz
2	02h	5 Hz
3	03h	1 Hz
4	04h	2 seconds
5	05h	5 seconds
6	06h	10 seconds
7	07h	30 seconds
8	08h	60 seconds
9	09h	5 minutes
10	0Ah	10 minutes
11	0Bh	2 Hz
12	0Ch	15 seconds
13	0Dh	20 Hz
255	FFh	Once only, immediately



Note – Certain message output types may not support >1 Hz output.

Table 5-23 GSOFF SUB-MESSAGE TYPE Byte Values

Byte Value		Meaning
Dec	Hex	
0	00h	Switch all GSOFF messages off
1	01h	Position Time (GPS)
2	02h	WGS-84, Lat, Long, Height
3	03h	WGS-84 ECEF (XYZ) Position
4	04h	Local Datum Lat, Long, Height
5	05h	Local Projection East, North, Up
6	06h	Reference → Rover Vector (dx, dy, dz)
7	07h	Reference → Rover Vector (delta East, delta North, delta Up)
8	08h	Velocity and Header information
9	09h	Dilution of Precision (DOP) Values
10	0Ah	Clock data
11	0Bh	Error Covariance Data
12	0Ch	Position Statistics
13	0Dh	Brief satellite information
14	0Eh	Detailed satellite information
15	0Fh	Receiver Serial Number data
16	10h	Current GPS time and UTC offset
17–25	11h–19h	Reserved
26	1Ah	Position Time (UTC)
27	1Bh	Attitude Info

Table 5-24 CMR MESSAGE TYPE Byte Values

Byte Value		Meaning
Dec	Hex	
0	00h	Standard
1	01h	High speed
2	02h	4000 compatible

Table 5-25 REAL-TIME 17 MESSAGE Bit Values

Bit	Meaning
7 (msb)	Reserved (set to zero)
6	Reserved (set to zero)
5	Reserved (set to zero)
4	Position Only 0: Disabled 1: Enabled
3	Streamed Position 0: Disabled 1: Enabled
2	Streamed Ephemeris 0: Disabled 1: Enabled
1	RT (Real-Time) Enhancements 0: Disabled 1: Enabled
0 (lsb)	Compact Format 0: Disabled 1: Enabled

Table 5-26 RTCM Flag Bit Values

Bit	Meaning
0	Output RTK (Type 18 and 19) 0: Off 1: On
1	Output DGPS (Type 1) 0: Off 1: On
2	Output DGPS (Type 9-3) 0: Off 1: On
3-7	Reserved (set to zero).

Table 5-27 ANTENNA TYPE Byte Values

Byte Value		Meaning
Dec	Hex	
0	00h	Unknown External
1	01h	4000ST Internal
2	02h	4000ST Kinematic Ext
3	03h	Compact Dome
4	04h	4000ST L1 Geodetic
5	05h	4000SST L1 L2 Geodetic
6	06h	4000SLD L1 L2 Square
7	07h	4000SX Helical
8	08h	4000SX Micro Square
9	09h	4000SL Micro Round
10	0Ah	4000SE Attachable
11	0Bh	4000SSE Kinematic L1 L2
12	0Ch	Compact L1 L2 with Groundplane
13	0Dh	Compact L1 L2
14	0Eh	Compact Done with Init
15	0Fh	L1 L2 Kinematic with Init
16	10h	Compact L1 L2 with Init
17	11h	Compact L1 with Init
18	12h	Compact L1 with Groundplane
19	13h	Compact L1
20	14h	Permanent L1 L2
21	15h	4600LS Internal
22	16h	4000SLD L1 L2 Round
23	17h	Dorne Margolin Model T
24	18h	Ashtech L1 L2 Geodetic L
25	19h	Ashtech Dorne Margolin

Table 5-27 ANTENNA TYPE Byte Values

Byte Value		Meaning
Dec	Hex	
26	1Ah	Leica SR299 External
27	1Bh	Trimble Choke Ring
28	1Ch	Dorne Margolin Model R
29	1Dh	Ashtech Geodetic L1 L2 P
30	1Eh	Integrated GPS Beacon
31	1Fh	Mobile GPS Antenna
32	20h	GeoExplorer Internal
33	21h	Topcon Turbo SII
34	22h	Compact L1 L2 with Groundplane with Dome
35	23h	Permanent L1 L2 with Dome
36	24h	Leica SR299/SR399 External Antenna
37	25h	Dorne Margolin Model B
38	26h	4800 Internal
39	27h	Micro Centered
40	28h	Micro Centered with Groundplane
47	29h	Rugged Micro Centered with 13-inch Groundplane

Table 5-28 DEVICE TYPE Byte Values

Byte Value		Meaning
Dec	Hex	
0	00h	Reserved
1	01h	Reserved
2	02h	1 PPS (Pulse per Second) Output
3	03h	Reserved
4	04h	Reserved
5	05h	Reserved
6	06h	Clarion JX-10 Radio
7	07h	CAN

Table 5-29 1 PPS CONTROL Byte Values

Byte Value		Meaning
Dec	Hex	
0	00h	1 PPS output is off
1	01h	1 PPS output is on

Table 5-30 JX-10 RADIO ENABLE FLAGS Byte Values

Byte Value		Meaning
Dec	Hex	
0	00h	Disable JX-10 Radio
1	01h	Enable JX-10 Radio

Table 5-31 JX-10 RADIO MODE Byte Values

Byte Value		Meaning
Dec	Hex	
0	00h	Rover
1	01h	Base Station

Table 5-32 JX-10 RADIO REPEATER Byte Values

Byte Value		Meaning
Dec	Hex	
0	00h	Disabled – radio is not operating as a repeater
1–8	01h–08h	Enabled – radio is operating as a repeater

Table 5-33 JX-10 RADIO TIME DIVISION MULTIPLEXING Values

Byte Value		Meaning
Dec	Hex	
0	00h	Disable (Allow multi-Hz outputs, but limit system to single rover)
1	01h	Enable (Allows for multiple rover receivers, but limits outputs to 1 Hz)

Table 5-34 STATIC/KINEMATIC MODE Byte Values

Byte Value		Meaning
Dec	Hex	
0	00h	Kinematic
1	01h	Static
2–255	02h–FFh	Reserved

65h

Command Packet 65h, GETAPPPFILE Application File Request

A specific application file can be downloaded from the MS750 receiver by sending the Command Packet 65h. If the request is valid, a copy of the application file is downloaded to the remote device in Report Packet 64h.

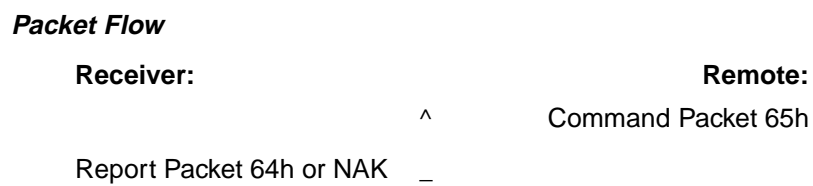

The receiver can store multiple application files (including a default application file, containing the factory default parameter settings) in the Application File directory. Each application file is assigned a number to give the file a unique identity within the directory. The application file containing the factory default values is assigned a System File Index code of zero (0).

Table 5-35 shows the packet structure. For more information, see Report Packet 64h, APPFILE, page 6-59.

Table 5-35 Command Packet 65h Structure

Byte #	Item	Type	Value	Meaning
0	STX	CHAR	02h	Start transmission
1	STATUS	CHAR	Table 4-2	Receiver status indicator
2	PACKET TYPE	CHAR	65h	Command Packet 65h
3	LENGTH	CHAR	Table 4-1	Data byte count
4-5	SYSTEM FILE INDEX	SHORT	0- <i>n</i>	Unique number (ID code) assigned to each of the application files stored in the Application File directory
6	CHECKSUM	CHAR	Table 4-1	Checksum value
7	ETX	CHAR	03h	End transmission

66h Command Packet 66h, GETAFDIR Application File Directory Listing Request

Command Packet 66h is used to request a directory listing of the application files stored in receiver memory. The receiver responds by sending the directory listing in Report Packet 67h.

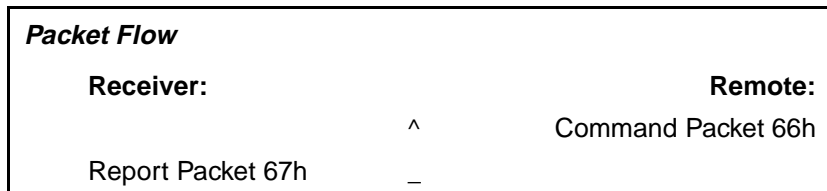

Table 5-36 describes the packet structure. For more information, see Report Packet 67h, RETAFDIR, page 6-60.

Table 5-36 Command Packet 66h Structure

Byte #	Item	Type	Value	Meaning
0	STX	CHAR	02h	Start transmission
1	STATUS	CHAR	Table 4-2	Receiver status code
2	PACKET TYPE	CHAR	66h	Command Packet 66h
3	LENGTH	CHAR	0h	Data byte count
4	CHECKSUM	CHAR	Table 4-1	Checksum value
5	ETX	CHAR	03h	End transmission

68h

Command Packet 68h, DELAPPPFILE Delete Application File Data Command

Command Packet 68h deletes the data for a specified application file. The application file is selected by specifying the System File Index assigned to the file.

<i>Packet Flow</i>	
Receiver:	Remote:
ACK or NAK	Command Packet 68h
	^
	-

Table 5-37 Command Packet 68h Structure

Byte #	Item	Type	Value	Meaning
0	STX	CHAR	02h	Start transmission
1	STATUS	CHAR	Table 4-2	Receiver status indicator
2	PACKET TYPE	CHAR	68h	Command Packet 68h
3	LENGTH	CHAR	01h	Data byte count
4-5	SYSTEM FILE INDEX	SHORT	0- <i>n</i>	Unique number assigned to each of the application files stored in the Application File directory
6	CHECKSUM	CHAR	Table 4-1	Checksum
7	ETX	CHAR	03h	End transmission

6Dh Command Packet 6Dh, ACTAPPFILE Activate Application File

Command Packet 6Dh is used to activate one of the application files stored in the Application File directory. The application file with the specified System File Index is activated.

<i>Packet Flow</i>	
Receiver:	Remote:
	^
ACK or NAK	Command Packet 6Dh
	-

Each application file is assigned a System File Index. The application file containing the factory default values is assigned an System File Index of zero (0), allowing this command to be used to reset the receiver to the factory default conditions. Table 5-38 describes the packet structure.

Table 5-38 Command Packet 6Dh Structure

Byte #	Item	Type	Value	Meaning
0	STX	CHAR	02h	Start transmission
1	STATUS	CHAR	Table 4-2	Receiver status indicator
2	PACKET TYPE	CHAR	6Dh	Command Packet 6Dh
3	LENGTH	CHAR	01h	Data byte count
4-5	SYSTEM FILE INDEX	SHORT	0- <i>n</i>	Unique number assigned to each of the application files stored in the Application File directory
6	CHECKSUM	CHAR	Table 4-1	Checksum
7	ETX	CHAR	03h	End transmission

81h

Command Packet 81h, KEYSIM Key Simulator

Command Packet 81h simulates any front panel key press.

<i>Packet Flow</i>	
Receiver:	Remote:
ACK	Command Packet 81h
^	
-	

Table 5-39 Command Packet 81h Structure

Byte #	Item	Type	Value	Meaning
0	STX	CHAR	02h	Start transmission
1	STATUS	CHAR	Table 4-2	Receiver status code
2	PACKET TYPE	CHAR	81h	Command Packet 81h
3	LENGTH	CHAR	01h	Data byte count
4	KEY ID	CHAR	Table 5-40	Key scan code ID
5	CHECKSUM	CHAR	Table 4-1	Checksum values
6	ETX	CHAR	03h	End transmission

Table 5-40 Key ID Code s

Scan Code	Receiver Key	ASCII Character
7Fh	<input type="button" value="CLEAR"/>	<input type="button" value="Del"/>
0Dh	<input type="button" value="ENTER"/>	<input type="button" value="Enter"/> <carriage return>
41h	Softkey Choice 1	<input type="button" value="A"/> <A>
42h	Softkey Choice 2	<input type="button" value="B"/>
43h	Softkey Choice 3	<C>
44h	Softkey Choice 4	<D>
1Dh	#	< ← >

Table 5-40 Key ID Code s

Scan Code	Receiver Key	ASCII Character
1Ch	\$	< → >
30h	0	<0>
31h	1	<1>
32h	2	<2>
33h	3	<3>
34h	4	<4>
35h	5	<5>
36h	6	<6>
37h	7	<7>
38h	8	<8>
39h	9	<9>
4Ch	STATUS	<L>
4Ah	SESSION	<J>
4Bh	SAT INFO	<K>
4Fh	LOG DATA	<O>
4Dh	CONTROL	<M>
50h	ALPHA	<P>
4Eh	MODIFY	<N>
1Bh	POWER	

82h

Command Packet 82h, SCRDUMP Screen Dump Request

Command Packet 82h has two forms—a command packet and report packet. Both packets are assigned the same hexadecimal code (82h).

<i>Packet Flow</i>	
Receiver:	Remote:
	^
Report Packet 82h	Command Packet 82h
	-

Command Packet 82h requests an ASCII representation of a MS750 simulated display screen. In response, Report Packet 82h sends the data used that is used to display the screen to the remote device in ASCII format.

Table 5-41 shows the command packet structure. For more information, see Report Packet 82h, SCRDUMP, page 6-70.

Table 5-41 Command Packet 82h Structure

Byte #	Item	Type	Value	Meaning
0	STX	CHAR	02h	Start transmission
1	STATUS	CHAR	Table 4-2	Receiver status code
2	PACKET TYPE	CHAR	82h	Command Packet 82h
3	LENGTH	CHAR	0h	Data bytes count
4	CHECKSUM	CHAR	Table 4-1	Checksum value
5	ETX	CHAR	03h	End transmission

6 Data Collector Format Report Packets

Data Collector Format report packets are usually sent in response to a command packet. The prime exception is Report Packet 40h (GSOF) which streams a selection of data reports to the remote device at intervals defined in the current application file.

Report packets are generated immediately after the request is received. The receiver always responds to requests for reports, even in cases where a report cannot be transmitted for some reason or the transmission of a report is not necessary. In these cases, the receiver sends an ACK or NAK to acknowledge the request.

6.1 Report Packet Summary

The following sections provide details for each command and report packet. Table 6-1 lists a summary of the report packets.

Table 6-1 Report Packet Summary

ID (Hex)	Name	Function	Page
07h	Report Packet 07h, RSERIAL	Receiver and Antenna Information Report	6-3
09h	Report Packet 09h, RECSTAT1	Receiver Status Report	6-5
40h	Report Packet 40h, GENOUT	General Output Record Reports	6-8
4Bh	Report Packet 4Bh, RETOPT	Receiver Options Parameters Report	6-9
55h	Report Packet 55h, RETSVDATA	Satellite Information Reports	6-33
57h	Report Packet 57h, RAWDATA	Position or Real-Time Survey Data Report	6-43
64h	Report Packet 64h, APPFILE	Application File Record Report	6-59
67h	Report Packet 67h, RETAFDIR	Directory Listing Report	6-60
6Eh	Report Packet 6Eh, BREAKRET	Break Sequence Return	6-64
82h	Report Packet 82h, SCRUMP	Screen Dump	6-70

07h

Report Packet 07h, RSERIAL Receiver and Antenna Information Report

Report Packet 07h is sent in response to the Command Packet 06h. The report returns the receiver and antenna serial number, antenna type, firmware processor versions, and the number of receiver channels.

<i>Packet Flow</i>		
Receiver:		Remote:
	^	Command Packet 06h
Report Packet 07h	—	

Table 6-2 describes the packet structure. For more information, see Command Packet 06h, GETSERIAL, page 5-3.

Table 6-2 Report Packet 07h Structure

Byte #	Item	Type	Value	Meaning
0	STX	CHAR	02h	Start transmission
1	STATUS	CHAR	Table 4-2	Receiver status code
2	PACKET TYPE	CHAR	07h	Report Packet 07h
3	LENGTH	CHAR	2Dh	Data byte count
4–11	RECEIVER SERIAL #	CHAR	<i>ASCII text</i>	Receiver serial number
12–19	RECEIVER TYPE	CHARs	MS750 + 3 spaces	Receiver model designation (MS750, plus 3 spaces)
20–24	NAV PROCESS VERSION	CHARs	<i>ASCII text</i>	Version number of NAV Processor firmware
25–29	SIG PROCESS VERSION	CHARs	<i>ASCII text (00000)</i>	Not applicable
30–34	BOOT ROM VERSION	CHARs	<i>ASCII text (00000)</i>	Not applicable
35–42	ANTENNA SERIAL #	CHARs	<i>ASCII text (8 spaces)</i>	Not used.
43–44	ANTENNA TYPE	CHAR	<i>ASCII text (2 spaces)</i>	Not used.
45–46	# CHANNELS	CHAR	12h	There are 18 receiver channels.
47–48	# CHANNELS L1	CHAR	09h	Nine (9) L1 receiver channels.
49	CHECKSUM	CHAR	Table 4-1	Checksum value
50	ETX	CHAR	03h	End transmission

09h

Report Packet 09h, RECSTAT1 Receiver Status Report

Report Packet 09h is sent in response to Command Packet 08h. The report packet returns receiver status information regarding position determination, the number of tracked satellites, the remaining battery capacity, and the remaining memory.

Packet Flow

Receiver:

Remote:

Report Packet 09h

^

Command Packet 08h

—

Table 6-3 describes the packet structure. For more information, see Command Packet 08h, GETSTAT1, page 5-4.

Table 6-3 Report Packet 09h Structure

Byte #	Item	Type	Value	Meaning
0	STX	CHAR	02h	Start transmission
1	STATUS	CHAR	Table 4-2	Receiver status indicator
2	PACKET TYPE	CHAR	09h	Report Packet 09h
3	LENGTH	CHAR	15h	Data byte count
4	POSITION FIX	CHAR	Table 6-4	Current GPS position fix mode
5	MEASUREMENT STATUS	CHAR	4Fh	Measurement Status is always set to '0' (4Fh) to indicate old measurements.
6-7	# SVS LOCKED	CHAR	00h-18h	Number of tracked satellites in the current constellation
8-10	# MEAS TO GO	CHARs	00h	Used with a type of kinematic survey which is beyond the scope of this manual
11-13	% BATTERY REMAINING	CHARs	64h	Battery time always set.
14-18	RESERVED	CHARs		Reserved
19-22	STATUS OF RECEIVER	CHARs	Table 6-5	Current action performed by the receiver
23-24	# L2 CHANNELS OPERATIONAL	CHARs	<i>channels</i>	Number of L2 channels selected for taking measurements
25	CHECKSUM	CHAR	Table 4-1	Checksum value
26	ETX	CHAR	03h	End transmission

Table 6-4 POSITION FIX Byte Values

Byte Value		Meaning
Dec	Hex	
0	00h	Position is not determined, or position has not changed since last request.
1	01h	0-D Position Fix (time only; 1 or more SVs required)
2	02h	1-D Position Fix (height only; 1 or more SVs required)
3	03h	2-D Position Fix (includes current latitude and longitude coordinates, height and time are fixed; 2 or more SVs required)
4	04h	2-D Position Fix (includes current latitude, longitude, and time; height is fixed; 3 or more SVs required)
5	05h	3-D Position Fix (includes current latitude, longitude, altitude, and time; 4 or more SVs required)

Table 6-5 STATUS OF RECEIVER Byte Values

ASCII	Byte Values				Meaning
	19	20	21	23	
SETT	53h	45h	54h	54h	Setting time
GETD	47h	45h	54h	44h	Updating ION/UTC/Health data
CAL1	43h	41h	4Ch	31h	Calibrating
MEAS	4Dh	45h	41h	53h	Static Survey Measurements
KINE	4Bh	49h	4Eh	45h	Kinematic Survey

40h

Report Packet 40h, GENOUT General Output Record Reports

When scheduled, Report Packet 40h is continuously output at the FREQUENCY specified by the current application file. The GENOUT report contains multiple sub-records as scheduled by the application file (subtype = 10, GSOF).

Packet Flow**Receiver:**

Report Packet 40h

Remote:

-

For information about controlling the record types included in Report Packet 40h, see 07h, page 6-3.



Note – Application files are created and uploaded to the receiver with the software tools included with the receiver. For more information, see Report Packet 07h, RSERIAL, page 6-3 and Command Packet 64h, APPFILE, page 5-10.

Table 6-6 describes the packet structure. The byte numbers in Table 6-6 are reset to 0 for each sub-record type. To approximate packet size, add the header and footer bytes to the sum of the byte counts for all records included in the packet.

Table 6-6 Report Packet 40h Structure

Byte #	Item	Type	Value	Meaning
0	STX	CHAR	02h	Start transmission
1	STATUS	CHAR	Table 4-2	Receiver status code
2	PACKET TYPE	CHAR	40h	Report Packet 40h
3	LENGTH	CHAR	00h–FAh	Data byte count
4	TRANSMISSION NUMBER	CHAR		Unique number assigned to a group record packet pages. Prevents page mismatches when multiple sets of record packets exist in output stream
5	PAGE INDEX	CHAR	00h–FFh	Index of current packet page
6	MAX PAGE INDEX	CHAR	00h–FFh	Maximum index of last packet in one group of records

Table 6-6 Report Packet 40h Structure (Continued)

Byte #	Item	Type	Value	Meaning
POSITION TIME (Type 1 Record)				
0	OUTPUT RECORD TYPE	CHAR	01h	Position Time Output Record
1	RECORD LENGTH	CHAR	0Ah	Bytes in record
2–5	GPS TIME (ms)	LONG	<i>msecs</i>	GPS time, in milliseconds of GPS week
6–7	GPS WEEK NUMBER	SHORT	<i>number</i>	GPS week count since January 1980
8	NUMBER OF SVS USED	CHAR	00h–0Ch	Number of satellites used to determine the position (0–12)
9	POSITION FLAGS 1	CHAR	Table 6-7	Reports first set of position attribute flag values
10	POSITION FLAGS 2	CHAR	Table 6-8	Reports second set of position attribute flag values
11	INITIALIZATION NUMBER	CHAR	00h–FFh	Increments with each initialization (modulo 256)

Table 6-6 Report Packet 40h Structure (Continued)

Byte #	Item	Type	Value	Meaning
LAT, LONG, HEIGHT (Type 2 Record)				
0	OUTPUT RECORD TYPE	CHAR	02h	Latitude, Longitude, and Height Output Record
1	RECORD LENGTH	CHAR	18h	Bytes in record
2–9	LATITUDE	DOUBLE	<i>radians</i>	Latitude from WGS-84 datum
10–17	LONGITUDE	DOUBLE	<i>radians</i>	Longitude from WGS-84 datum
18–25	HEIGHT	DOUBLE	<i>meters</i>	Height from WGS-84 datum
ECEF POSITION (Type 3 Record)				
0	OUTPUT RECORD TYPE	CHAR	03h	Earth-Centered, Earth-Fixed (ECEF) Position Output Record
1	RECORD LENGTH	CHAR	18h	Bytes in record
2–9	X	DOUBLE	<i>meters</i>	WGS-84 ECEF X-axis coordinate
10–17	Y	DOUBLE	<i>meters</i>	WGS-84 ECEF Y-axis coordinate
18–25	Z	DOUBLE	<i>meters</i>	WGS-84 ECEF Z-axis coordinate

Table 6-6 Report Packet 40h Structure (Continued)

Byte #	Item	Type	Value	Meaning
LOCAL DATUM POSITION (Type 4 Record)				
0	OUTPUT RECORD TYPE	CHAR	04h	Local Datum Position Output Record
1	RECORD LENGTH	CHAR	20h	Bytes in record
2–9	LOCAL DATUM ID	CHARs	<i>ASCII text</i>	Identification name or code assigned to local datum
10–17	LOCAL DATUM LATITUDE	DOUBLE	<i>radians</i>	Latitude in the local datum
18–25	LOCAL DATUM LONGITUDE	DOUBLE	<i>radians</i>	Longitude in the local datum
26–33	LOCAL DATUM HEIGHT	DOUBLE	<i>meters</i>	Height in the local datum
LOCAL ZONE POSITION (Type 5 Record)				
0	OUTPUT RECORD TYPE	CHAR	05h	Local Zone Position Output Record
1	RECORD LENGTH	CHAR	28h	Bytes in record
2–9	LOCAL DATUM ID	CHARs	<i>ASCII text</i>	Identification code or name assigned to coordinate datum.
10–17	LOCAL ZONE ID	CHARs	<i>ASCII text</i>	Identification code or name assigned to coordinate zone.
18–25	LOCAL ZONE EAST	DOUBLE	<i>meters</i>	East coordinate of local zone
26–33	LOCAL ZONE NORTH	DOUBLE	<i>meters</i>	North coordinate of local zone
34–41	LOCAL DATUM HEIGHT	DOUBLE	<i>meters</i>	Height in the Local datum

Table 6-6 Report Packet 40h Structure (Continued)

Byte #	Item	Type	Value	Meaning
ECEF DELTA (Type 6 Record) *				
0	OUTPUT RECORD TYPE	CHAR	06h	Earth-Centered, Earth-Fixed Delta Output Record
1	RECORD LENGTH	CHAR	18h	Bytes in record
2–9	DELTA X	DOUBLE	<i>meters</i>	ECEF X axis delta between rover and base station positions
10–17	DELTA Y	DOUBLE	<i>meters</i>	ECEF Y axis delta between rover and base station positions
18–25	DELTA Z	DOUBLE	<i>meters</i>	ECEF Z axis delta between rover and base station positions
TANGENT PLANE DELTA (Type 7 Record) *				
0	OUTPUT RECORD TYPE	CHAR	07h	Tangent Plane Delta Output Record
1	RECORD LENGTH	CHAR	18h	Bytes in record
2–9	DELTA EAST	DOUBLE	<i>meters</i>	East component of vector from base station to rover, projected onto a plane tangent to the WGS-84 ellipsoid at the base station
10–17	DELTA NORTH	DOUBLE	<i>meters</i>	North component of tangent plane vector
18–25	DELTA UP	DOUBLE	<i>meters</i>	Difference between ellipsoidal height of tangent plane at base station and a parallel plane passing through rover point

* These records are only output if a valid DGJPS/RTK solution is computed.

Table 6-6 Report Packet 40h Structure (Continued)

Byte #	Item	Type	Value	Meaning
VELOCITY DATA (Type 8 Record) *				
0	OUTPUT RECORD TYPE	CHAR	08h	Velocity Data Output Record
1	RECORD LENGTH	CHAR	0Dh	Bytes in record
2	VELOCITY FLAGS	CHAR	Table 6-9	Velocity status flags
3-6	SPEED	FLOAT	<i>meters per second</i>	Horizontal speed
7-10	HEADING	FLOAT	<i>radians</i>	True north heading in the WGS-84 datum
11-14	VERTICAL VELOCITY	FLOAT	<i>meters per second</i>	Vertical velocity
15-18*	LOCAL HEADING (See Note.)	FLOAT	<i>radian</i>	Heading in local datum
* Local heading field is only present if local coordinate system is loaded.				
PDOP INFO (Type 9 Record) *				
0	OUTPUT RECORD TYPE	CHAR	09h	PDOP Information Output Record
1	RECORD LENGTH	CHAR	10h	Bytes in record
2-5	PDOP	FLOAT		Positional Dilution Of Precision
6-9	HDOP	FLOAT		Horizontal Dilution Of Precision
10-13	VDOP	FLOAT		Vertical Dilution Of Precision
14-17	TDOP	FLOAT		Time Dilution Of Precision

Table 6-6 Report Packet 40h Structure (Continued)

Byte #	Item	Type	Value	Meaning
CLOCK INFO (Type 10 Record)				
0	OUTPUT RECORD TYPE	CHAR	0Ah	Clock Information Output Record
1	RECORD LENGTH	CHAR	11h	Bytes in record
2	CLOCK FLAGS	CHAR	Table 6-10	Clock status flags
3–10	CLOCK OFFSET	DOUBLE	<i>msecs</i>	Current clock offset
11–18	FREQUENCY OFFSET	DOUBLE	<i>parts per million</i>	Offset of local oscillator from nominal GPS L1 frequency

Table 6-6 Report Packet 40h Structure (Continued)

Byte #	Item	Type	Value	Meaning
POSITION VCV INFO (Type 11 Record)				
0	OUTPUT RECORD TYPE	CHAR	0Bh	Position VCV Information Output Record
1	RECORD LENGTH	CHAR	22h	Bytes in record
2–5	POSITION RMS	FLOAT		Root means square of the error of the position calculated for overdetermined positions.
6–9	VCV xx	FLOAT		The variance-covariance matrix contains the positional components of the inverted normal matrix of the position solution based on a ECEF WGS-84 reference.
10–13	VCV xy	FLOAT		
14–17	VCV xz	FLOAT		
18–21	VCV yy	FLOAT		
22–25	VCV yz	FLOAT		
26–29	VCV zz	FLOAT		
30–33	UNIT VARIANCE	FLOAT		Unit variance of the position solution
34–35	NUMBER OF EPOCHS	SHORT	<i>count</i>	Number of measurement epochs used to compute the position. Could be greater than 1 for positions subjected to STATIC constraint. Always 1 for Kinematic.

Table 6-6 Report Packet 40h Structure (Continued)

Byte #	Item	Type	Value	Meaning
POSITION SIGMA INFO (Type 12 Record)				
0	OUTPUT RECORD TYPE	CHAR	0Ch	Position Sigma Information Output Record
1	RECORD LENGTH	CHAR	26h	Bytes in record
2–5	POSITION RMS	FLOAT		Root means square of position error calculated for overdetermined positions
6–9	SIGMA EAST	FLOAT	<i>meters</i>	
10–13	SIGMA NORTH	FLOAT	<i>meters</i>	
14–17	COVAR. EAST-NORTH	FLOAT	<i>number</i>	Covariance East-North (dimensionless)
18–21	SIGMA UP	FLOAT	<i>meters</i>	
22–25	SEMI MAJOR AXIS	FLOAT	<i>meters</i>	Semi-major axis of error ellipse
26–29	SEMI-MINOR AXIS	FLOAT	<i>meters</i>	Semi-minor axis of error ellipse
30–33	ORIENTATION	FLOAT	<i>degrees</i>	Orientation of semi-major axis, clockwise from True North
34–37	UNIT VARIANCE	FLOAT		Valid only for over determined solutions. Unit variance should approach 1.0. A value of less than 1.0 indicates that apriori variances are too pessimistic
38–39	NUMBER OF EPOCHS	SHORT	<i>count</i>	Number of measurement epochs used to compute the position. Could be greater than 1 for positions subjected to STATIC constraint. Always 1 for Kinematic.

Table 6-6 Report Packet 40h Structure (Continued)

Byte #	Item	Type	Value	Meaning
SV BRIEF INFO (Type 13 Record)				
0	OUTPUT RECORD TYPE	CHAR	0Dh	Brief Satellite Information Output Record
1	RECORD LENGTH	CHAR		Bytes in record
2	NUMBER OF SVS	CHAR	00h–18h	Number of satellites included in record*
<i>The following bytes are repeated for NUMBER OF SVS</i>				
	PRN	CHAR	01h–20h	Pseudorandom number of satellite (1–32)
	SV FLAGS1	CHAR	Table 6-11	First set of satellite status bits
	SV FLAGS2	CHAR	Table 6-12	Second set of satellite status bits

* The number of SVs includes all tracked satellites, all satellites used in the position solution, and all satellites in view.

Table 6-6 Report Packet 40h Structure (Continued)

Byte #	Item	Type	Value	Meaning
SV DETAILED INFO (Type 14 Record)				
0	OUTPUT RECORD TYPE	CHAR	0Eh	Detailed Satellite Information Output Record
1	RECORD LENGTH	CHAR	1 + 8x(number of SVs)	Bytes in record
2	NUMBER OF SVS	CHAR	00h–18h	Number of satellites included in record ²
<i>The following bytes are repeated for NUMBER OF SVS</i>				
	PRN	CHAR	01h–20h	Pseudorandom number of satellite (1–32)
	SVFLAGS1	CHAR	Table 6-11	First set of satellite status bits
	SVFLAGS2	CHAR	Table 6-12	Second set of satellite status bits
	ELEVATION	CHAR	<i>degrees</i>	Angle of satellite above horizon
	AZIMUTH	SHORT	<i>degrees</i>	Azimuth of satellite from true North
	SNR L1	CHAR	dB * 4	Signal-to-noise ratio of L1 signal (multiplied by 4). ¹
	SNR L2	CHAR	dB * 4	Signal-to-noise ratio of L2 signal (multiplied by 4). ¹

- 1 Set to zero for satellites which are not tracked on the current frequency (L1 or L2).
- 2 The number of SVs includes all tracked satellites, all satellites used in the position solution, and all satellites in view.

Table 6-6 Report Packet 40h Structure (Continued)

Byte #	Item	Type	Value	Meaning
RECEIVER SERIAL NUMBER (Type 15 Record)				
0	OUTPUT RECORD TYPE	CHAR	0Fh	Receiver Serial Number Output Record
1	RECORD LENGTH	CHAR	04h	Bytes in record
2-5	SERIAL NUMBER	LONG	<i>number</i>	Receiver serial number
CURRENT TIME (Type 26 Record)				
0	OUTPUT RECORD TYPE	CHAR	1Ah	Current Time Output Record
1	RECORD LENGTH	CHAR	09h	Bytes in record
2-5	GPS MILLISEC OF WEEK	LONG	<i>msecs</i>	Time when packet is sent from receiver, in GPS milliseconds of week
6-7	GPS WEEK NUMBER	SHORT	<i>number</i>	Week number since start of GPS time
8-9	UTC OFFSET	SHORT	<i>seconds</i>	GPS-to-UTC time offset
10	FLAGS	CHAR	Table 6-13	Flag bits indicating validity of Time and UTC offset parameters
Length + 4	CHECKSUM	CHAR	Table 4-1	Checksum value
Length + 5	ETX	CHAR	03h	End transmission

Table 6-6 Report Packet 40h Structure (Continued)

Byte #	Item	Type	Value	Meaning
ATTITUDE INFO (Type 27 Record)				
0-3	GPS TIME	LONG	msecs	GPS time in milliseconds of GPS week
4	FLAGS	CHAR	Table 6-16	Flag bits indicating validity of attitude components
5	NUMBER OF SATELLITES USED	CHAR	00h-0ch	Number of satellites used to calculate attitude
6	CALCULATION MODE	CHAR	Table 6-17	Positioning mode
7	RESERVED			Reserved
8-15	TILT	DOUBLE	radians	Title relative to horizontal plane
16-23	YAW	DOUBLE	radians	Rotation about the vertical axis
24-31	RESERVED			Reserved
32-39	RANGE	DOUBLE	meters	Distance between master and slave antennas
40-41	PDOP	SHORT		Position Dilution of Precision

Table 6-7 POSITION FLAGS 1 Bit Values

Bit	Meaning
0	New Position 0: No 1: Yes
1	Clock Fix Calculated for Current Position 0: No 1: Yes
2	Horizontal Coordinates Calculated this Position 0: No 1: Yes
3	Height Calculated this Position 0: No 1: Yes
4	Weighted Position 0: No 1: Yes
5	Overdetermined Position 0: No 1: Yes
6	Ionosphere-Free Position 0: No 1: Yes
7	Position Uses Filtered L1 Pseudoranges 0: No 1: Yes

Table 6-8 POSITION FLAGS 2 Bit Values

Bit	Meaning
0	Differential Position 0: No 1: Yes
1	Differential Position Method 0: RTCM 1: RTK
2	Differential Position Type 0: Differential position is code (RTCM) or a float position (RTK) 1: Differential position is fixed integer phase position (RTK)
3	Narrowlane or Widelane Data 0: Differential position uses L1, L2 or Narrowlane data 1: Differential position uses Widelane data
4	Position Determined with STATIC as a Constraint 0: No 1: Yes
5–7	Reserved (set to zero)

Table 6-9 VELOCITY FLAGS Bit Values

Bit	Meaning
0	Velocity Data Validity 0: Not valid 1: Valid
1	Velocity Computation 0: Computed from Doppler 1: Computed from consecutive measurements
2–7	Reserved (set to zero)

Table 6-10 CLOCK FLAGS Bit Values

Bit	Meaning
0	Clock Offset Validity 0: Not valid 1: Valid
1	Frequency Offset Validity 0: Not valid 1: Valid
2	Receiver in Anywhere Fix Mode 0: No 1: Yes
3–7	Reserved. Set to zero.

Table 6-11 SV FLAGS 1 Bit Values

Bit	Meaning
0	Satellite Above Horizon 0: No 1: Yes
1	Satellite Currently Assigned to a Channel (trying to track) 0: No 1: Yes
2	Satellite Currently Tracked on L1 Frequency 0: No 1: Yes
3	Satellite Currently Tracked on L2 Frequency 0: No 1: Yes
4	Satellite Reported at Base on L1 Frequency 0: No 1: Yes
5	Satellite Reported at Base on L2 Frequency 0: No 1: Yes
6	Satellite Used in Position 0: No 1: Yes
7	Satellite Used in Current RTK Process (Search, Propagate, Fix Solution) 0: No 1: Yes

Table 6-12 SV FLAGS 2 Bit Values

Bit	Meaning
0	Satellite Tracking P-Code on L1 Band 0: No 1: Yes
1	Satellite Tracking P-Code on L2 Band 0: No 1: Yes
2-7	Reserved. Set to zero.

Table 6-13 FLAGS Bit Values

Bit	Meaning
0	Time Information (week and milliseconds of week) Validity 0: Not valid 1: Valid
1	UTC Offset Validity 0: Not valid 1: Valid

Table 6-14 ATTITUDE FLAGS

Bit	Meaning
0	Calibrated 0: No 1: Yes
1	Tilt Valid 0: No 1: Yes
2	Yaw Valid 0: No 1: Yes
3	Reserved
4	Range Valid 0: No 1: Yes
5	Reserved
6	Reserved
7	Reserved

Table 6-15 ATTITUDE CALCULATION FLAGS

Bit	Meaning
4	DGPS 0: No 1: Yes
6	0: No Position 1: Autonomous Position 2: RTK/Float Position 3: RTK/Fix Position 4: DGPS Position

4BH

Report Packet 4Bh, RETOPT

Receiver Options Parameters Report

Report Packet 4Bh is sent in response to Command Packet 4Ah. The report contains a listing of the optional hardware and firmware installed on the receiver at the factory. Also included are the current parameter settings for Elevation Mask, PDOP Mask, and Synchronization Time.

Packet Flow**Receiver:****Remote:**

Report Packet 4Bh

^

Report Packet 4Ah

-

Table 6-16 describes the packet structure. For more information, see Command Packet 4Ah, GETOPT, page 5-5.

Table 6-16 Report Packet 4Bh Structure

Byte #	Item	Type	Value	Meaning
0	STX	CHAR	02h	Start transmission
1	STATUS	CHAR	Table 4-2	Receiver status code
2	PACKET TYPE	CHAR	4Bh	Report Packet 4Bh
3	LENGTH	CHAR	31h	Data byte count
4	ELEVATION MASK	CHAR	00h–5Ah	Elevation Mask setting in degrees (0–90 degrees)
5	PDOP MASK	CHAR	00h–FFh	PDOP Mask setting. The PDOP Mask has a scale of 0.1 and values range from 0 (00.0) to 255 (25.5). If the PDOP Mask is greater than 25.5, 255 is returned
6–7	SYNC TIME	SHORT	01h–0Ah	Synchronization time, in 0.1 second units, ranging from 0.1 to 1.0 seconds (range = 1–10)
8–9	FASTEST MEAS RATE	SHORT	0.0–6553.5	Fastest measurement rate, in 0.1 second units
10	CURRENT PORT ID	CHAR	01h–04h	ID code assigned to the current port (port 1–4)
11	PORTS AVAILABLE	CHAR	01h–04h	Number of receiver ports (1–4) installed
12	L1/L2 OPERATION	CHAR	Table 6-17	L1/L2 operating mode. Always set to 2 for the MS Series receiver.
13–21	RESERVED	CHAR	00h	Reserved (set to zero)
22	NMEA-0183 OUTPUTS	CHAR	Table 6-18	NMEA-0183 Output Option installation flag
23	RESERVED	CHAR	00h	Reserved
24	RTCM INPUT	CHAR	Table 6-19	RTCM Input installation flag

Table 6-16 Report Packet 4Bh Structure (Continued)

Byte #	Item	Type	Value	Meaning
25	RESERVED	CHAR	00h	Reserved
26	RTCM OUTPUT	CHAR	Table 6-20	RTCM Output installation flag
27–29	RESERVED	CHAR	00h	Reserved (set to zero)
30	PULSE PER SEC	CHAR	Table 6-21	1 PPS Output Option is not applicable.
31	RESERVED	CHAR	00h	Reserved (set to zero)
32	COCOM ALT/SPEED	CHAR	Table 6-22	COCOM Alt/Speed Option installation flag
33–34	MEMORY INSTALLED	SHORT	<i>kilobytes</i>	Always set to zero for the MS Series receiver.
35	% MEMORY USED	CHAR	00h	Always set to zero for the MS Series receiver.
36–42	RESERVED	CHAR	00h	Reserved (set to zero)
43	RESERVED	CHAR	00h	Reserved (set to zero)
44	REAL-TIME SURVEY DATA	CHAR	Table 6-23	Real-Time Survey Data Option installation flag
45	RESERVED	CHAR	00h	
46	SUMMARY OF RTK OPTIONS	CHAR	Table 6-24	RTK option summary flags
47–52	RESERVED	CHAR	00h	Reserved (set to zero)
53	Checksum	CHAR	Table 4-1	Checksum value
54	ETX	CHAR	03h	End transmission

Table 6-17 L1/L2 OPERATION Byte Values

Byte Value		Meaning
Dec	Hex	
1	01h	L1 only
2	02h	L1 and L2

Table 6-18 NMEA-0183 OUTPUTS Byte Values

Byte Value		Meaning
Dec	Hex	
0	00h	Not installed
1	01h	Installed

Table 6-19 RTCM INPUT

Byte Value		Meaning
Dec	Hex	
0	00h	Not installed
1	01h	Installed

Table 6-20 RTCM OUTPUT

Byte Value		Meaning
Dec	Hex	
0	00h	Not installed
1	01h	Installed

Table 6-21 PULSE PER SEC Byte Values

Byte Value		Meaning
Dec	Hex	
0	00h	Unavailable
1	01h	Installed
2	02h	Installed, but 1 PPS Output is disabled

Table 6-22 COCOM ALT/SPEED Byte Values

Byte Value		Meaning
Dec	Hex	
0	00h	Not installed
1	01h	Installed

Table 6-23 REAL-TIME SURVEY DATA Byte Values

Value		Meaning
Dec	Hex	
0	00h	Not installed
1	01h	Installed

Table 6-24 SUMMARY OF RTK OPTIONS Flag Bits

Bit	Meaning
0–1	Reserved (set to zero)
2	RTK Fast Static 0: Not Installed 1: Installed
3	RTK OTF 0: Not installed 1: Installed
4	Reserved (set to zero)
5	CMR Input 0: Not installed 1: Installed
6	CMR Output 0: Not installed 1: Installed
7	Reserved (set to zero)

55h

Report Packet 55h, RETSVDATA Satellite Information Reports

Report Packet 55h is sent in response to Command Packet 54h. The report includes either the Ephemeris or Almanac information for a specific satellite, or ION/UTC data, the Enabled/Disabled state and Heed/Ignore Health state of all satellites, or the condition of satellite status flags for one satellite or all satellites.

<i>Packet Flow</i>		
Receiver:		Remote:
	^	Command Packet 54h
Report Packet 55h	-	

Only the satellite information, requested by Command Packet 54h is sent in the report packet. As a result, several forms of the Report Packet 55h can be requested.

Table 6-25 through Table 6-29 describe the structure of the report packets.



Note – Returns a NAK if the GETSVDATA request meets one of the following criteria:

- SV PRN is out of range 1–32 (except for SV flags).
- Data Switch is out of range.
- Data is not available for the requested SV.

SV FLAGS Report

The SV FLAGS report is sent when Command Packet 54h is used to request the status of the SV Flags for one satellite or all satellites. The Command Packet 54h DATA SWITCH byte (byte 4) is set to zero (0) when requesting the report. Table 6-25 describes the packet structure.

Table 6-25 Report Packet 55h SV FLAGS Report Structure

Byte #	Item	Type	Value	Meaning
0	STX	CHAR	02h	Start transmission
1	STATUS	CHAR	Table 4-2	Receiver status
2	PACKET TYPE	CHAR	55h	Report Packet 55h
3	LENGTH	CHAR	Table 4-1	Data byte count
4	DATA TYPE INDICATOR	CHAR	00h	SV FLAGS Report
5	SV PRN #	CHAR	00h–20h	Pseudorandom number of satellite (1–32) or zero when requesting flag status of all satellites
6–9	EPHEMERIS FLAGS	LONG	32 flag bits	For all 32 satellites, the flags show availability of Ephemeris data when set to one.*
10–13	ALMANAC FLAGS	LONG	32 flag bits	For all 32 satellites, the flags show availability of Almanac data when set to one.*
14–17	SVS DISABLED FLAGS	LONG	32 flag bits	Flags show Enabled or Disabled status of all satellites. When set to one, satellite is disabled.*
18–21	SVS UNHEALTHY FLAGS	LONG	32 flag bits	Flags show the health of satellites. When set to one, satellite is currently unhealthy.*
22–25	TRACKING L1 FLAGS	LONG	32 flag bits	Flags show satellites tracked on L1 when set to one.*

* Bit 0 = PRN 1.

Table 6-25 Report Packet 55h SV FLAGS Report Structure (Continued)

Byte #	Item	Type	Value	Meaning
26–29	TRACKING L2 FLAGS	LONG	32 flag bits	Flags show satellites tracked on L2 when set to one.*
30–33	Y-CODE FLAGS	LONG	32 flag bits	Flags show satellites with Anti-Spoofing turned on when set to one.*
34–37	P-CODE ON L1 FLAGS	LONG	32 flag bits	Flags show satellites which are tracking P-code on the L1. Flags are not set for satellites not tracked on L1.*
38–41	RESERVED	LONG	32 flag bits	Reserved (set to zero)
42–45	RESERVED	LONG	32 flag bits	Reserved (set to zero)
46–49	RESERVED	LONG	32 flag bits	Reserved (set to zero)
50–53	RESERVED	LONG	32 flag bits	Reserved (set to zero)
54	CHECKSUM	CHAR	Table 4-1	Checksum value
55	ETX	CHAR	03h	End transmission

* Bit 0 = PRN 1.

EPHEMERIS Report

The EPHEMERIS Report is sent when Command Packet 54h is used to request the Ephemeris for one satellite or all satellites. The GETSVDATA DATA SWITCH byte (byte 4) is set to one (1) to request the report. Table 6-26 describes the packet structure.

The Ephemeris data follows the standard defined by GPS ICD-200 except for CUC, CUS, CIS, and CIC. These values need to be multiplied by π to become the units specified in the GPS ICD-200 document. The Ephemeris Flags are described in Table 6-27.

Table 6-26 Report Packet 55h EPHEMERIS Report Structure

Byte #	Item	Type	Value	Meaning
0	STX	CHAR	02h	Start transmission
1	STATUS	CHAR	Table 4-2	Receiver status
2	PACKET TYPE	CHAR	55h	Report Packet 55h
3	LENGTH	CHAR	Table 4-1	Data byte count
4	DATA TYPE INDICATOR	CHAR	01h	Ephemeris Report
5	SV PRN #	CHAR	00h–20h	Pseudorandom number of satellite (1–32) or 0 when data is for all satellites.
6–7	EPH WEEK #	SHORT	GPS ICD-200*	Ephemeris Week Number
8–9	IODC	SHORT	GPS ICD-200*	
10	RESERVED	CHAR	GPS ICD-200*	Reserved (set to zero)
11	IODE	CHAR	GPS ICD-200*	Issue of Data Ephemeris
12–15	TOW	LONG	GPS ICD-200*	Time of week
16–19	TOC	LONG	GPS ICD-200*	
20–23	TOE	LONG	GPS ICD-200*	
24–31	TGD	DOUBLE	GPS ICD-200*	

Table 6-26 Report Packet 55h EPHEMERIS Report Structure

Byte #	Item	Type	Value	Meaning
32–39	AF2	DOUBLE	GPS ICD-200*	
40–47	AF1	DOUBLE	GPS ICD-200*	
48–55	AF0	DOUBLE	GPS ICD-200*	
56–63	CRS	DOUBLE	GPS ICD-200*	
64–71	DELTA N	DOUBLE	GPS ICD-200*	
72–79	M SUB 0	DOUBLE	GPS ICD-200*	
80–87	CUC	DOUBLE	GPS ICD-200*	
88–95	ECCENTRICITY	DOUBLE	GPS ICD-200*	
96–103	CUS	DOUBLE	GPS ICD-200*	
104–111	SQRT A	DOUBLE	GPS ICD-200*	
112–119	CIC	DOUBLE	GPS ICD-200*	
120–127	OMEGA SUB 0	DOUBLE	GPS ICD-200*	
128–135	CIS	DOUBLE	GPS ICD-200*	
136–143	I SUB 0	DOUBLE	GPS ICD-200*	
144–151	CRC	DOUBLE	GPS ICD-200*	
152–159	OMEGA	DOUBLE	GPS ICD-200*	
160–167	OMEGA DOT	DOUBLE	GPS ICD-200*	
168–175	I DOT	DOUBLE	GPS ICD-200*	
176–179	FLAGS	LONG	Table 6-27	Shows status of Ephemeris Flags
180	CHECKSUM	CHAR	Table 4-1	Checksum value
181	ETX	CHAR	03h	End transmission

* Refer to the U.S. Government document GPS ICD-200 for detailed information.

Table 6-27 EPHemeris FLAGS

Bit(s)	Description	Location
0	Data flag for L2 P-code	Sub 1, word 4, bit 1
1–2	Codes on L2 channel	Sub 1, word 3, bits 11–12
3	Anti-spoof flag: Y-code on: from ephemeris	Sub 1–5, HOW, bit 19
4–9	SV health: from ephemeris	Sub 1, word 3, bits 17–22
10	Fit interval flag	Sub 2, word 10, bit 17
11–14	URA: User Range Accuracy	Sub 1, word 3, bits 13–16
15	URA may be worse than indicated Block I: Momentum Dump flag	Sub 1–5, HOW, bit 18
16–18	SV Configuration: SV is Block I or Block II	Sub 4, page 25, word and bit depends on SV
19	Anti-spoof flag: Y-code on	Sub 4, page 25, word and bit depends on SV

ALMANAC Report

The ALMANAC Report is sent when Command Packet 54h is used to request the Almanac for one satellite or all satellites. The Command Packet 54h DATA SWITCH byte (byte 4) is set to zero (2) when requesting the report. Data follows the format specified by GPS ICD-200.

Table 6-28 describes the packet structure.

Table 6-28 Command Packet 55h ALMANAC Report Structure

Byte #	Item	Type	Value	Meaning
0	STX	CHAR	02h	Start transmission
1	STATUS	CHAR	Table 4-2	Receiver status
2	PACKET TYPE	CHAR	55h	Report Packet 55h
3	LENGTH	CHAR	Table 4-1	Data byte count
4	DATA TYPE INDICATOR	CHAR	02h	Almanac data
5	SV PRN #	CHAR	00h–20h	Pseudorandom number of satellite (1–32) or 0 when data is for all satellites.
6–9	ALM DECODE TIME	LONG		Full GPS seconds from the start of GPS time.
10–11	AWN	SHORT	GPS ICD-200*	
12–15	TOA	LONG	GPS ICD-200*	
16–23	SQRTA	DOUBLE	GPS ICD-200*	
24–31	ECCENT	DOUBLE	GPS ICD-200*	
32–39	ISUBO	DOUBLE	GPS ICD-200*	
40–47	OMEGADOT	DOUBLE	GPS ICD-200*	
48–55	OMEGSUBO	DOUBLE	GPS ICD-200*	
56–63	OMEGA	DOUBLE	GPS ICD-200*	
64–71	MSUBO	DOUBLE	GPS ICD-200*	
72	ALM HEALTH	CHAR	GPS ICD-200*	
73	CHECKSUM	CHAR	Table 4-1	Checksum value
74	ETX	CHAR	03h	End transmission

* Refer to the U. S. Government document GPS ICD-200 for detailed information.

RETSVDATA UTC/ION Report

The UTC/ION report is sent when Command Packet 54h is used to request the UTC (Universal Time Coordinated) and Ionospheric data. The Command Packet 54h DATA SWITCH byte (byte 4) is set to three (3) when requesting the report.

Data follows the standard defined within GPS ICD-200 except that some parameters are expanded. A NAK is returned if Command Packet 54h meets one of the following criteria:

- SV PRN out of range (not 1–32)
- Command Packet 54h DATA SWITCH value is out of range
- Data is not available for requested SV

Table 6-29 describes the packet structure.

Table 6-29 RETSVDATA UTC/ION Packet Structure

Byte #	Item	Type	Value	Meaning
0	STX	CHAR	02h	Start transmission
1	STATUS	CHAR	Table 4-2	Receiver status
2	PACKET TYPE	CHAR	55h	Report Packet 55h
3	LENGTH	CHAR	Table 4-1	Data byte count
4	DATA TYPE INDICATOR	CHAR	03h	UTC/ION Report
5	SV PRN #	CHAR	00h	Data for all satellites

* Refer to the U. S. Government document GPS ICD-200 for detailed information.

Table 6-29 RETSVDATA UTC/ION Packet Structure (Continued)

Byte #	Item	Type	Value	Meaning
Begin UTC Data				
6–13	ALPHA 0	DOUBLE	GPS ICD-200*	
14–21	ALPHA 1	DOUBLE	GPS ICD-200*	
22–29	ALPHA 2	DOUBLE	GPS ICD-200*	
30–37	ALPHA 3	DOUBLE	GPS ICD-200*	
38–45	BETA 0	DOUBLE	GPS ICD-200*	
46–53	BETA 1	DOUBLE	GPS ICD-200*	
54–61	BETA 2	DOUBLE	GPS ICD-200*	
62–69	BETA 3	DOUBLE	GPS ICD-200*	
Begin Ionospheric Data				
70–77	ASUB0	DOUBLE	GPS ICD-200*	
78–85	ASUB1	DOUBLE	GPS ICD-200*	
86–93	TSUB0T	DOUBLE	GPS ICD-200*	
94–101	DELTATLS	DOUBLE	GPS ICD-200*	
102–109	DELTATLSF	DOUBLE	GPS ICD-200*	
110–117	IONTIME	DOUBLE	GPS ICD-200*	
118	WNSUBT	CHAR	GPS ICD-200*	
119	WNSUBLSF	CHAR	GPS ICD-200*	
120	DN	CHAR	GPS ICD-200*	
121–126	RESERVED	CHARs	GPS ICD-200*	Reserved (set to zero)
127	CHECKSUM	CHAR	Table 4-1	Checksum value
128	ETX	CHAR	03h	End transmission

* Refer to the U. S. Government document GPS ICD-200 for detailed information.

57h

Report Packet 57h, RAWDATA Position or Real-Time Survey Data Report

Report Packet 57h is sent in response to one of the following requests:

- Command Packet 56h
- Real-Time Survey Data streaming is enabled in the application file with Command Packet 64h
- A simulated front panel command

Packet Flow	
Receiver:	Remote:
	^ Command Packet 56h or RT Survey Data Request or Front Panel Command
Report Packet 57h or NAK	—

A NAK is returned if the Real-Time Survey Data option (RT17) is not installed and the application file is configured to stream real-time survey data.

Report Packet 57h can contain one of the following types of raw data, depending on options selected in Command Packet 56h:

- Expanded Format (*.DAT Record Type 17 style data) raw satellite measurements
- Concise Format (*.DAT Record Type 17 style data) raw satellites measurements
- Position data (*.DAT RecordType 11)

The Expanded and Concise records can also include Enhanced record data, including Real-Time Flags and IODE information if these options are enabled in the application file. For more information, see 07h, page 6-3.

Packet Paging and Measurement Counting

The Raw satellite data responses follow either the Expanded or the Concise format and usually exceed the byte limit for RS-232 Serial Interface Specification packets. To overcome the packet size limitation, the data is included in several subpackets called pages. The PAGE INDEX byte (Byte 4) identifies the packet page index and the maximum page index included for the measurement epoch (0 of 2, 1 of 2, 2 of 2).

The first and subsequent packet pages are filled with a maximum of 248 bytes consisting of 4 bytes of page and flag information and 244 bytes of raw satellite data. The raw satellite data is split where ever the 244 byte boundary falls, regardless of internal variable boundaries. Therefore the external device receiving the multiple pages must reconstruct the raw satellite record using the 244 byte pages before parsing the data. This format is maintained for the position record, even though it never extends beyond 244 bytes.

Determining the LENGTH Byte of Records

The total length of the Raw Satellite Data (ignoring the protocol framing and the paging bytes) may be computed as follows:

Expanded Format $LENGTH = 17 + N*48 + M*24 + N*J*12$

Concise Format $LENGTH = 17 + N*27 + M*13 + N*J*3$

where:

- N is the number of satellites
- M is the number of satellites with L2 data
- J is either 1 if REAL-TIME DATA is ON, or 0 if REAL-TIME DATA is OFF.

Expanded Record Format

Table 6-30 shows the structure of Report Packet 57h when Expanded Record format is enabled with Command Packet 56h.

Table 6-30 Report Packet 57h Structure (Expanded Format)

Byte #	Item	Type	Value	Meaning
0	STX	CHAR	02h	Start transmission
1	STATUS	CHAR	Table 4-2	Receiver status
2	PACKET TYPE	CHAR	57h	RAWDATA
3	LENGTH	CHAR	Table 4-1	Data byte count
4	RECORD TYPE	CHAR	Table 6-32	Raw data record type
5	PAGING INFO	CHAR	Table 6-33	b7–b4 is the current page number. b3–b0 is the total pages in this epoch (1 of 3, 2 of 3, 3 of 3).
6	REPLY #	CHAR	00h–FFh	Roll-over counter which is incremented with every report but remains constant across pages within one report. This value should be checked on the second and subsequent pages to ensure that report pages are not mismatched with those from another report.
7	FLAGS	CHAR	Table 6-34	Bit 0 must be set to 0 to enable Expanded Record format.

Table 6-30 Report Packet 57h Structure (Expanded Format)

Byte #	Item	Type	Value	Meaning
Begin Expanded Format Record Header (17 bytes)				
8–15	RECEIVE TIME	DOUBLE	<i>msecs</i>	Receive time within the current GPS week (common to code and phase data).
16–23	CLOCK OFFSET	DOUBLE	<i>msecs</i>	Clock offset value. A value of 0.0 indicates that clock offset is not known.
24	# OF SVS IN RECORD	CHAR		Number of SV data blocks included in record.
Begin data for first satellite in constellation (repeated for up to n SVs)				
Begin Real-Time Survey Data (48 bytes * n)				
	SV PRN #	CHAR	01h–20h	Pseudorandom number of satellite (1–32)
	FLAGS1	CHAR	Table 6-35	First set of status flags
	FLAGS2	CHAR	Table 6-36	Second set of status flags
	FLAG STATUS	CHAR	Table 6-37	Determines whether the bit values for FLAGS1 and FLAGS2 are valid.
	ELEVATION ANGLE	SHORT	<i>degrees</i>	Satellite elevation angle (negative or positive value)
	AZIMUTH	SHORT	<i>degrees</i>	Satellite azimuth

Table 6-30 Report Packet 57h Structure (Expanded Format)

Byte #	Item	Type	Value	Meaning
Begin L1 Data				
	L1 SNR	DOUBLE	<i>dB</i>	Measure of satellite signal strength.
	FULL L1 C/A CODE PSEUDORANGE	DOUBLE	<i>meters</i>	Full L1 C/A code or P-code pseudorange (see bit 0 of FLAGS2)
	L1 CONTINUOUS PHASE	DOUBLE	<i>L1 cycles</i>	L1 Continuous Phase. Range-Rate sign convention: When pseudorange is increasing, the phase is decreasing and the Doppler is negative
	L1 DOPPLER	DOUBLE	<i>Hz</i>	L1 Doppler
	RESERVED	DOUBLE	0.0	Reserved.
Begin L2 Data (available if bit 0 of FLAGS1 is set to 1) (24 bytes * n)				
	L2 SNR	DOUBLE	<i>dB</i>	Measure of satellite signal strength.
	L2 CONTINUOUS PHASE	DOUBLE	<i>L2 cycles</i>	L2 Continuous Phase is in L2 cycles if bit 5 of FLAGS1 = 1.
	L2 P-CODE - L1 C/A CODE P-RANGE	DOUBLE	<i>meters</i>	L2 P-Code or L2 Encrypted Code (see bit 1 and bit 2 of FLAGS2) - L1 C/A-Code or P-code (see bit 0 of FLAGS2) pseudorange (valid only if bit 5 of FLAGS1 = 1).

Table 6-30 Report Packet 57h Structure (Expanded Format)

Byte #	Item	Type	Value	Meaning
<i>Begin Enhanced Record[†] if bit 1 of the FLAGS byte set to 1 (12 bytes * n)</i>				
	IODE	CHAR	00h–FFh	Issue of Data Ephemeris.
	L1 SLIP COUNTER	CHAR	00h–FFh	Roll-over counter is incremented for each occurrence of detected cycle-slips on L1 carrier phase.
	L2 SLIP COUNTER	CHAR	00h–FFh	Roll-over counter is incremented for each occurrence of detected cycle-slips on the L2 carrier phase. The counter always increments when L2 changes from C/A code to Encrypted code and vice versa.
	RESERVED	CHAR	—	Reserved (set to zero)
	L2 DOPPLER	DOUBLE	Hz	L2 Doppler
<i>Repeat previous bytes for remaining satellites in constellation</i>				
	CHECKSUM	SHORT	Table 4-1	Checksum value
	ETX	CHAR	03h	End transmission

Concise Record Format

Table 6-31 shows the structure of Report Packet 57h when Concise Record format is enabled with Command Packet 56h.

Table 6-31 Report Packet 57h Structure (Concise Format)

Byte #	Item	Type	Value	Meaning
0	STX	CHAR	02h	Start transmission
1	STATUS	CHAR	Table 4-2	Receiver status
2	PACKET TYPE	CHAR	57h	RAWDATA
3	LENGTH	CHAR	Table 4-1	Data byte count
4	RECORD TYPE	CHAR	Table 6-32	Raw data record type
5	PAGING INFO	CHAR	Table 6-33	b7–b4 is the current page number. b3–b0 is the total pages in this epoch (1 of 3, 2 of 3, 3 of 3).
6	REPLY #	CHAR	00h–FFh	Roll-over counter is incremented with every report but remains constant across pages within one report. This value should be checked on second and subsequent pages to avoid mismatching report pages with those of another report.
7	FLAGS	CHAR	Table 6-34	Bit 0 must be set to 1 to enable Concise Record format.

Table 6-31 Report Packet 57h Structure (Concise Format) (Continued)

Byte #	Item	Type	Value	Meaning
<i>Begin Concise Record Header (17 bytes)</i>				
8–15	RECEIVE TIME	DOUBLE	<i>msecs</i>	Receive time within current GPS week (common to code and phase data)
16–23	CLOCK OFFSET	DOUBLE	<i>msecs</i>	Clock offset value. A value of 0.0 indicates that clock offset is not known.
24	# OF SVS IN RECORD	CHAR	<i>blocks</i>	Number of SV data blocks included in record.
<i>Begin data for first satellite in constellation (repeated for up to n SVs)</i>				
<i>Begin Real-Time Survey Data (27 bytes * n)</i>				
	SV PRN #	CHAR	01h–20h	Satellite pseudorandom number (1–32)
	FLAGS1	CHAR	Table 6-35	First set of satellite status flags
	FLAGS2	CHAR	Table 6-36	Second set of satellite status flags
	ELEVATION ANGLE	CHAR	<i>degrees</i>	Satellite elevation angle (negative or positive).
	AZIMUTH	SHORT	<i>degrees</i>	Azimuth of satellite

Table 6-31 Report Packet 57h Structure (Concise Format) (Continued)

Byte #	Item	Type	Value	Meaning
Begin L1 Data				
	L1 SNR	CHAR	<i>dB * 4</i>	Measure of satellite signal strength. The value needs to be divided by 4.
	FULL L1 C/A CODE PSEUDORANGE	DOUBLE	<i>meters</i>	Full L1 C/A code or P-code pseudorange (see bit 0 of FLAGS2).
	L1 CONTINUOUS PHASE	DOUBLE	<i>L1 cycles</i>	L1 continuous phase. Range-Rate sign convention: When pseudorange is increasing, the phase is decreasing and the Doppler is negative.
	L1 DOPPLER	FLOAT	<i>Hz</i>	L1 Doppler
Begin L2 Data if bit 0 of FLAGS1 set to 1 (13 bytes * n)				
	L2 SNR	CHAR	<i>dB * 4</i>	Measure of satellite signal strength. The value needs to be divided by 4.
	L2 CONTINUOUS PHASE	DOUBLE	<i>L2 cycles</i>	L2 continuous phase is in L2 cycles if bit 5 of FLAGS1 = 1.
	L2 P-CODE ¹ - L1 C/A CODE ² P-RANGE	FLOAT	<i>meters</i>	Valid if bit 5 of FLAGS1 is set to 1.

1 L2 encrypted. See bit 1 and bit 2 of FLAGS2.

2 P-code. See bit 0 of FLAGS2.

Table 6-31 Report Packet 57h Structure (Concise Format) (Continued)

Byte #	Item	Type	Value	Meaning
<i>Begin Enhanced Record¹ if bit 1 of the FLAGS byte is set to 1 (3 bytes * n)</i>				
	IODE	CHAR	00h–FFh	Issue of Data Emphemeris
	L1 SLIP COUNTER	CHAR	00h–FFh	Roll-over counter is incremented for each occurrence of detected cycle-slips on L1 carrier phase
	L2 SLIP COUNTER	CHAR	00h–FFh	Roll-over counter is incremented for each occurrence of detected cycle-slips on the L2 carrier phase. The counter always increments when L2 changes from C/A code to Encrypted code and vice versa
<i>Repeat previous bytes for remaining satellites in constellation</i>				
	CHECKSUM	SHORT	Table 4-1	Checksum value
	ETX	CHAR	03h	End transmission

- 1 To be compatible with Trimble software, this data must be stripped off before record 17 is stored in a *.DAT file.

Table 6-32 RECORD TYPE Byte Values

Byte Value		Meaning
Dec	Hex	
0	00h	Real-Time Survey Data
1	01h	Position Data

Table 6-33 PAGE INFO Bit Values

Bit Value	Meaning
0–3	Total page count
4–7	Current page number

Table 6-34 FLAGS Bit Values

Bit	Meaning
<i>Real-Time Survey Data</i>	
0	Raw Data Format 0: Expanded *.DAT Record Type 17 format 1: Concise *.DAT Record Type 17 format
1	Enhanced Record with real-time flags and IODE information 0: Disabled-record data is not enhanced 1: Enabled-record data is enhanced
2–7	Reserved (set to zero)

Table 6-35 FLAGS1 Bit Values

Bit	Meaning
0	L2 Data Loaded and Phase Valid (also see bit 6) 0: Off 1: On
1	L1 Cycle-slip (since last record 17 write) 0: Off 1: On
2	L2 Cycle-slip (since last record 17 write) 0: Off 1: On
3	L1 Phase Lock Point (redundant, for diagnostics) 0: Off 1: On
4	L1 Phase valid (lock-point valid) 0: Off 1: On
5	L2 Pseudorange (reset = squared - L2 phase) 0: Off (always for MS Series receiver) 1: On
6	L1 Data Valid (non-zero but bytes always present) (also see bit 4), reset = only L2 data loaded (also see FLAG STATUS in Table 6-37) 0: Off 1: On
7	New Position Computed during this Receiver Cycle 0: Off 1: On

Table 6-36 FLAGS2 Bit Values

Bit	Meaning
0	L1 Tracking Mode 0: C/A code 1: P-code
1	L2 Tracking Mode 0: C/A code (or encrypted P-code) 1: P-code
2	L2 Tracking Encryption Code 0: Off 1: On
3	Filtered L1 Band Pseudorange Corrections 0: Off 1: On
4–7	Reserved (bits set to zero)

Table 6-37 FLAG STATUS Bit Values

Bit	Meaning
0	Validity of FLAGS1 and FLAGS2 Bit Values 0: Bit 6 of FLAGS1 and bit 0–7 of FLAGS2 are undefined 1: bit 6 of FLAGS1 and bit 0–7 of FLAGS2 are valid (always set for RAWDATA)
2–7	Reserved (bits set to zero)

Position Record (Record Type 11)

Table 6-38 shows the structure of Report Packet 57h when the Position Record is enabled with Command Packet 56h.

$$\text{Position Record Length} = 78 + N * 2$$

where N is the number of satellites.

Table 6-38 Position Record (Record Type 11) Structure

Byte #	Item	Type	Value	Meaning
0	STX	CHAR	02h	Start transmission
1	STATUS	CHAR	Table 4-2	Receiver status
2	PACKET TYPE	CHAR	57h	RAWDATA
3	LENGTH	CHAR	Table 4-1	Data byte count
4	RECORD TYPE	CHAR	Table 6-32	Raw data record type
5	PAGING INFO	CHAR	Table 6-33	b7–b4 is the current page number. b3–b0 is the total pages in this epoch (1 of 3, 2 of 3, 3 of 3).
6	REPLY #	CHAR	00h–FFh	Roll-over counter which is incremented with every report but remains constant across pages within one report. This value should be checked on the second and subsequent pages to ensure that report pages are not mismatched with those from another report.

Table 6-38 Position Record (Record Type 11) Structure (Continued)

Byte #	Item	Type	Value	Meaning
<i>Begin Position Record (Record 11) (78 + (nSVs * 2) bytes)</i>				
7–14	LATITUDE	DOUBLE		Latitude in semi-circles
15–22	LONGITUDE	DOUBLE		Longitude in semi-circles
23–30	ALTITUDE	DOUBLE	<i>meters</i>	Altitude
31–38	CLOCK OFFSET	DOUBLE	<i>meters</i>	Clock offset
39–46	FREQUENCY OFFSET	DOUBLE	<i>Hz</i>	Frequency offset from 1536*1.023 MHz
47–54	PDOP	DOUBLE		PDOP (dimensionless)
55–62	LATITUDE RATE	DOUBLE	<i>radians per second</i>	Latitude rate
63–70	LONGITUDE RATE	DOUBLE	<i>radians per second</i>	Longitude rate
71–78	ALTITUDE RATE	DOUBLE	<i>meters per second</i>	Altitude rate
79–82	GPS MSEC OF WEEK	LONG	msecs	Position time tag
83	POSITION FLAGS	CHAR	Table 6-39	Position status flags
84	# OF SVS	CHAR	00h–0Ch	Number of satellites used to compute position solution (0–12)
<i>The next 2 bytes are repeated for each satellite used to compute position</i>				
	CHANNEL #	CHAR		Channel used to acquire satellite measurement. Zero is reported for RTK solutions.
	PRN #	CHAR	01–20h	PRN number of satellite (1–32)
	CHECKSUM	SHORT	Table 4-1	Checksum value
	ETX	CHAR	03h	End transmission

Table 6-39 POSITION FLAGS Bit Values

Bit	Meaning
0–2	Position flag and position type definition 0: 0-D position fix (clock-only solution) (1+ SVs) (if # of SVs used is non-zero) 1: 1-D position fix (height only with fixed latitude/ longitude) (2+ SVs) 2: 2-D position fix (fixed height and clock) [2+ SVs] 3: 2-D position fix (fixed height) (3+ SVs) 4: 3-D solution (4+ SVs)
3	RTK Solution 0: Floating integer ambiguity 1: Fixed integer ambiguity
4	DGPS Differential Corrections 0: No DGPS corrections are used in position computation. 1: DGPS corrections are used to compute position.
5	Reserved; bit set to 0
6	Real-Time Kinematic (RTK) Positions 0: False 1: True
7	Position Derived While Static 0: False 1: True

64h

Report Packet 64h, APPFILE Application File Record Report

Report Packet 64h is sent to the remote device when Command Packet 65h is sent to request a specific application file. Command Packet 65h requests the application file by System File Index.

<i>Packet Flow</i>		
Receiver:		Remote:
	^	Command Packet 65h
Report Packet 64h	—	

For detailed information, about MS Series Application Files and guidelines for using application files to control remote devices, see 07h, page 6-3.

The Application File Record Report format is identical to the format used for Command Packet 64h. For detailed information, see Packet Paging, page 5-11.

67h Report Packet 67h, RETAFDIR Directory Listing Report

Report Packet 67h sends a listing of the application files in the application file directory. The report is requested with Command Packet 66h. For more information, see Command Packet 66h, GETAFDIR, page 5-38.

<i>Packet Flow</i>	
Receiver:	Remote:
	^
Report Packet 67h	Command Packet 66h
	—

Report Packet 67h can exceed the maximum data byte limit (248 bytes of data) for RS-232 Serial Interface Specification packets, depending on the number of application files stored in memory. Each application file directory entry occupies 16 bytes. Report Packet 67h is divided into subpackets called pages when the data byte limit is exceeded. The PAGE INDEX and MAXIMUM PAGE INDEX bytes are used to account for the pages included in the report (0 of 2, 1 of 2, 2 of 2).

The TX BLOCK IDENTIFIER uses a roll-over counter to assign a transaction number to the report packet pages. The TX BLOCK IDENTIFIER INDEX number is useful for preventing data mismatches when stream synchronization is lost.

Table 6-40 describes the packet structure.

Table 6-40 Report Packet 67h Structure

Byte #	Item	Type	Value	Meaning
0	STX	CHAR	02h	Start transmission
1	STATUS	CHAR	Table 4-2	Receiver status code
2	PACKET TYPE	CHAR	67h	Report Packet 67h
3	LENGTH	CHAR	Table 4-1	Data byte count
4	TX BLOCK IDENTIFIER	CHAR	00h–FFh	Unique number assigned to every application file transfer.
5	PAGE INDEX	CHAR	00h–FFh	Page index assigned to packet page
6	MAXIMUM PAGE INDEX	CHAR	00h–FFh	Page index assigned to the last packet page
<i>Begin Directory List</i>				
7	# APP FILES		00h– <i>n</i>	Number of application files in directory

* The Date/Time fields should all be relative to UTC.

Table 6-40 Report Packet 67h Structure (Continued)

Byte #	Item	Type	Value	Meaning
First Application File Directory Record				
<i>The following record block (bytes 8–23) is repeated for every application file stored in directory. At least one application file exists (SYSTEM FILE INDEX number 0, the Default Application File). The receiver can store at least 10 user-defined application file records.</i>				
8	SYSTEM FILE INDEX	CHAR	Table 6-41	Record number assigned to the file
9–16	APP FILE NAME	CHARs	ASCII text	Name of application file (8 ASCII characters)
17	CREATION YEAR*	CHAR	00h–FFh	Year when file is created. Based on the years since 1900 (1900 = 00)
18	CREATION MONTH*	CHAR	01h–0Ch	Month of the year when file is created (1–12)
19	CREATION DAY*	CHAR	01h–1Fh	Day of the month when file is created (1–31)
20	CREATION HOUR*	CHAR	00h–17h	Hour when file is created (0–23)
21	CREATION MINUTES*	CHAR	00h–3Bh	Minutes of hour when file is created (0–59)
22–23	APP FILE SIZE	SHORT	bytes	Size of file.
<i>Begin Second Application File Record Entry</i>				
.				
.				
.				
<i>End with Last Application File Record Entry</i>				
Length +4	CHECKSUM	CHAR	Table 4-1	Checksum value
Length +5	ETX	CHAR	03h	End transmission

* The Date/Time fields should all be relative to UTC.

Table 6-41 SYSTEM FILE INDEX Values

Byte Value		Meaning
Dec	Hex	
0	00h	Application file record number of the default application file which contains factory default values
1– <i>n</i>	01h– <i>nh</i>	Application file record number

6Eh Report Packet 6Eh, BREAKRET Break Sequence Return

Command Packet 6Eh returns the receivers current serial port communication parameters, receiver version numbers and dates, and communication protocol settings when the remote device sends a 250 millisecond (minimum duration) break sequence.

<i>Packet Flow</i>		
Receiver:		Remote:
	^	Break Sequence
Report Packet 6Eh	-	

Sending a Break Sequence

To initiate a break sequence return, the following events need to occur:

1. The remote device sends a break sequence with a minimum duration of 250 milliseconds to the receiver. For example, pressing **Ctrl** + **Break** from a PC is equivalent to sending a break sequence.
2. The receiver detects the break signal and responds by setting the communication parameters for the serial port to 9600 baud, 8 data bits, no parity, and 1 stop bit.
3. The receiver outputs an Identity Message through the serial port to the remote device (see Table 6-42).

Table 6-42 describes the structure of Report Packet 6Eh.

Table 6-42 Report Packet 6Eh Structure

Byte #	Item	Type	Value	Meaning
0	STX	CHAR	02h	Start transmission
1	STATUS	CHAR	Table 4-2	Receiver status indicator
2	PACKET TYPE	CHAR	6Eh	Report Packet 6Eh
3	LENGTH	CHAR	Table 4-1	Data byte count
	PRODUCT	CHARs	<i>comma delimited ASCII string</i>	Comma-delimited ASCII string indicating the receiver product family name. For more information, see PRODUCT, page 6-66.
	PORT	CHARs	<i>comma delimited ASCII string</i>	Comma-delimited ASCII string indicating the serial port settings and the break sequence acknowledgment code. For more information, see PORT, page 6-67.
	VERSION	CHARs	<i>comma delimited ASCII string</i>	Comma-delimited ASCII string indicating the software version number and version release date. For more information, see VERSION, page 6-68.
	COMM	CHARs	<i>comma delimited ASCII string</i>	Comma-delimited ASCII string indicating the communication protocols supported on serial port. For more information, see COMM, page 6-69.
	CHECKSUM	CHAR	Table 4-1	Checksum value
	ETX	CHAR	03h	End transmission

Identity Message Format

The following example shows the structure of a Identity Message:

```
<STX><0><0x6E><93>  
PRODUCT,MSSERIES;  
PORT,1,38400,38400,8,1,N,F;  
VERSION,2.21,11/21/98,,;  
COMM,DCOL,NMEA;  
<CHECKSUM><ETX>
```



Note – The previous example shows the strings on separate lines for clarity, but the actual message is one continuous string of characters.

Detailed information about the four parameter strings is described in the following sections.

PRODUCT

For the MS Series receivers, the PRODUCT string is always set to MSSERIES. The string always begins with the word PRODUCT, followed by a comma, followed by the word MSSERIES, and terminated with a semicolon as in the following example:

```
PRODUCT,MSSERIES;
```

PORT

The PORT parameter is a comma-delimited string of ASCII characters describing the current input baud rate, output baud rate, data bits, stop bits, parity, and the break sequence status acknowledgment. The syntax of the comma delimited string is shown below:

PORT,input baud rate,output baud rate,data bits,stop bits,parity,boolean acknowledgement;

The string always begins with the word PORT, and the end of the string is always terminated with a semicolon character. Commas are used to delimit the other fields within the string.

The input and output protocols can be 2400, 4800, 9600, 19200, or 38400 baud. The number of data bits is always set to 8, and the number of stop bits is always set to 1. The parity can be O (Odd), E (Even), or N (None). The string always identifies the current communication parameters defined for the port.

The final field in the string contains the boolean (T or F) code used to acknowledge the break sequence. A value of T (True) indicates that the communication parameters for the port are going to be set to 9600,8,N,1 for at least 5 seconds. A value of F (False) indicates that the receiver outputs the identity strings at 9600,8,N,1 and returns to the current port settings.

A sample string is shown below:

`PORT,38400,38400,8,1,N,F;`

VERSION

The VERSION parameter is a comma-delimited string of ASCII characters with the MS Series firmware and hardware version numbers and release dates. The end of the string is terminated with a semicolon. The syntax of the comma-delimited ASCII string is shown below:

VERSION,software version number,version date,hardware version,version date;

The string always begins with the word VERSION, followed by the software version number and date and two commas (,). The slash character (/) is used to separate the month, day, and year in date fields. The string is always terminated with a semicolon character. The following example shows a sample string:

VERSION,2.21,11/21/98,,;

COMM

The COMM parameter is a comma-delimited string of communication protocols supported on the connected serial port. The string has the following syntax:

COMM,first protocol,...last protocol;

The string always begins with the word COMM and a comma, followed by the comma-delimited list of protocols. The string is terminated with a semicolon character. Table 6-43 identifies the ASCII codes assigned to the various protocols supported by the MS Series receiver.

Table 6-43 COMM

Protocol	Meaning
DCOL	Data Collector Format
NMEA	Outputs a subset of NMEA-0183 messages
RTCM	Radio Technical Commission for Maritime Services protocol specification RTCM SC-104

For example, the comma-delimited ASCII string for the connected serial port which supports DCOL and RTCM is shown below:

COMM,DCOL,RTCM;

82h Report Packet 82h, SCRDUMP Screen Dump

Command Packet 82h has two forms—a command packet and report packet. Both packets are assigned the same hexadecimal code (82h). For more information, see Command Packet 82h, SCRDUMP, page 5-43.

<i>Packet Flow</i>	
Receiver:	Remote:
Report Packet 82h	Command Packet 82h
^	
-	

Report Packet 82h is sent in response to Command Packet 82h. The receiver generates an ASCII representation (a dump) of a MS Series display screen, and sends the dump to the remote device in Report Packet 82h. Table 6-44 shows the packet structure.

Table 6-44 Report Packet 82h Structure

Byte #	Item	Type	Value	Meaning
0	STX	CHAR	02h	Start transmission
1	STATUS	CHAR	Table 4-2	Receiver status code
2	PACKET TYPE	CHAR	82h	Report Packet 82h
3	LENGTH	CHAR	A1h	Data byte count
4–163	ASCII DATA	CHARs		ASCII data
164	CURSOR POSITION	CHAR		Position of the cursor.
165	CHECKSUM	CHAR	Table 4-1	Checksum value
166	ETX	CHAR	03h	End transmission

7 MS750 Operation

The MS750 receiver address a wide range of precise positioning and navigation applications, including construction, mining and agriculture equipment positioning, robotic equipment control, hydrographic surveying, and any other application requiring reliable centimeter-level guidance at a high update rate and low latency. See Figure 7-1. The receiver display and keyboard allow easy configuration and status monitoring.

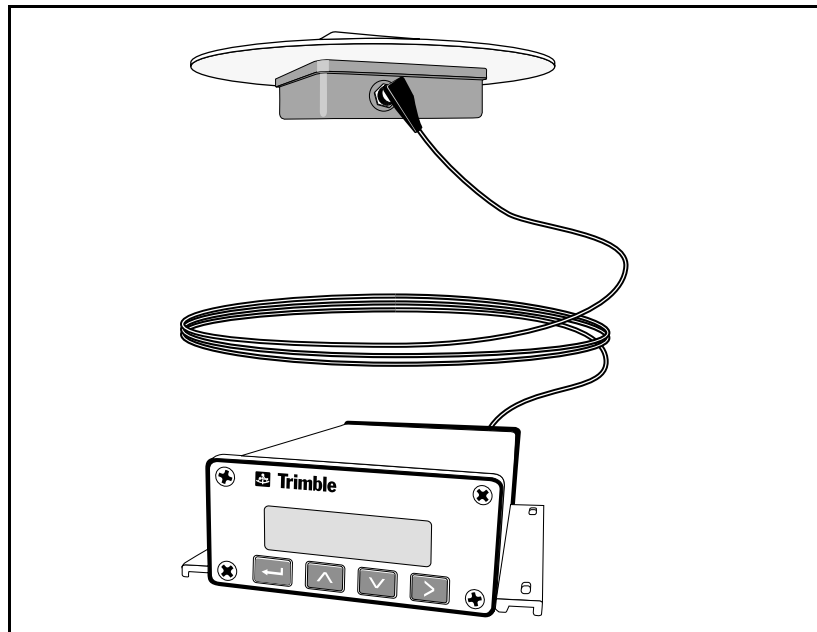

Figure 7-1 MS750 Receiver

7.1 Installing the MS750 Receiver

This section shows you how to:

- Unpack and inspect the shipment
- Install the MS750 receiver
- Install the antenna
- Connect power and install interface devices

We recommend you read this section before attempting to install the MS750 receiver.

7.1.1 Unpacking and Inspecting the Shipment

Visually inspect the shipping cartons for any signs of damage or mishandling before unpacking the receiver. Immediately report any damage to the shipping carrier.

Opening the Shipping Carton

The shipment can include one or more cartons, depending on the number of optional accessories ordered. Open the shipping cartons and make sure that all of the components indicated on the bill of lading are present. Table 7-1 identifies the standard components included with the MS750 receiver.

Table 7-1 MS750 Components

Qty	P/N	Description
1	36487-00	MS750 Receiver
1	30945	Data/Power Cable
1	37382	Data/PPS Cable
1	36574-00	MS750 Operation Manual
1	28073-30	Configuration Toolbox Software

The shipment may also include a combination of the options and accessories listed in Table 7-2.

Table 7-2 Options and Accessorie s(Optional)

P/N	Description
38159-00	Rugged L1/L2 Machine Antenna
38326-00	Micro-Centered Antenna
23158	Removable Groundplane
17515-01	Type N-to-N, 5-meter Antenna Cable
17515-02	Type N-to-N, 15-meter Antenna Cable
33980-25	Type N-to-N, Rugged 7.5-meter Antenna Cable
33980-99	Type N-to-N, Rugged 30-meter Antenna Cable
30700	Data Extension Cable, 3.6 meter
38497-00	MS750 AC Power Supply
38312-11	MS750 Extended Hardware Warranty, 1 Year
38313-11	MS750 Firmware Upgrade Service, 1 Year

Reporting Shipping Problems

Report any problems discovered after you unpack the shipping cartons to both Trimble Customer Support and the shipping carrier.

7.1.2 Installation Guidelines

The MS750 receiver is designed to be mounted on a flat surface in any orientation. The bottom of the receiver features mounting flanges for securing to a flat surface with screws.

Choosing a Location

The MS750 receiver can be installed in any convenient location close to the external device. The location should provide the following requirements:

- Allow visibility of the front panel
- Provide clearance for the antenna and interface connections
- Positioned within 3.6 meters (12 ft.) of the external instrument port (The optional 3.6-meter (12 ft.) extension cable can be used to extend the distance.)

Considering Environmental Conditions

Although the MS750 receiver is housed with a waterproof housing, it should be installed in a dry location. Avoid exposure to extreme environmental conditions, including:

- Water
- Excessive Heat > 60°C (140°F)
- Excessive cold < -20°C (-4°F)
- Corrosive fluids and gases

Avoiding these conditions improves the MS750 receiver's performance and long-term product reliability.

7.1.3 Mounting the Receiver

To mount the MS750 receiver:

1. Drill four holes in the mounting surface using the slotted holes in the mounting flange as a template.



Note – If machine screws are used, tap the mounting holes to fasten the receiver to the mounting surface. Use 8-32 UNF socket head cap screws to fasten the receiver to the mounting surface. Alternatively, use self-tapping screws to secure the receiver.

2. Use screws to secure the brackets to the mounting surface.

7.1.4 Grounding the Receiver

The MS750 receiver can be grounded to minimize external noise which might influence the operation of the receiver. Grounding the receiver is optional and is normally not required.

The MS750 receiver has an 8-32 UNF threaded post on the mounting flange for connecting a ground wire to the receiver. Connect the ground wire to the post and secure it with an 8-32 nut, and connect the opposite end of the wire to the vehicle/vessel chassis or frame.

7.1.5 Mounting the Antenna

Choose a location for the antenna that is safe from damage during normal operation. Observe the following guidelines when selecting the antenna location:

- Place the antenna on a flat surface along the center line of the vehicle.
- Choose an area with clear view to the sky above metallic objects.
- Avoid mounting the antenna close to stays, electrical cables, metal masts, and other antennas.
- Do not mount the antenna near transmitting antennas, radar arrays, or satellite communication equipment.
- Avoid areas with high vibration, excessive heat, electrical interference, and strong magnetic fields (for sources of electrical interference, see Sources of Electrical Interference below).

Sources of Electrical Interference

Avoid the following sources of electrical and magnetic noise:

- Gasoline engines (spark plugs)
- Televisions and PC monitors
- Alternators and generators
- Electric motors
- Propeller shafts
- Equipment with DC-to-AC converters
- Florescent lights
- Switching power supplies

7.1.6 MS750 Connections

Figure 7-2 shows the MS750 back panel and its associated ports.

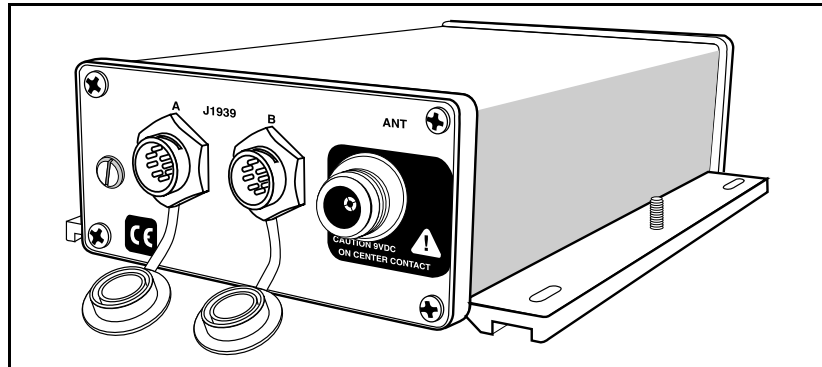

Figure 7-2 Back Panel

The Port A and Port B connectors can both accept power. The data/power cable (P/N 30945) supplies power. See MS750 Cables and Connectors, page 7-68 for cable and connector pin-out information.

7.1.7 Routing and Connecting the Antenna Cable

After mounting the antenna, route the antenna cable from the GPS antenna to the MS750 receiver (see Figure 7-3). Avoid the following hazards when routing the antenna cable:

- Sharp ends or kinks in the cable
- Hot surfaces (exhaust manifolds or stacks)
- Rotating or reciprocating equipment
- Sharp or abrasive surfaces
- Door and window jams
- Corrosive fluids or gases

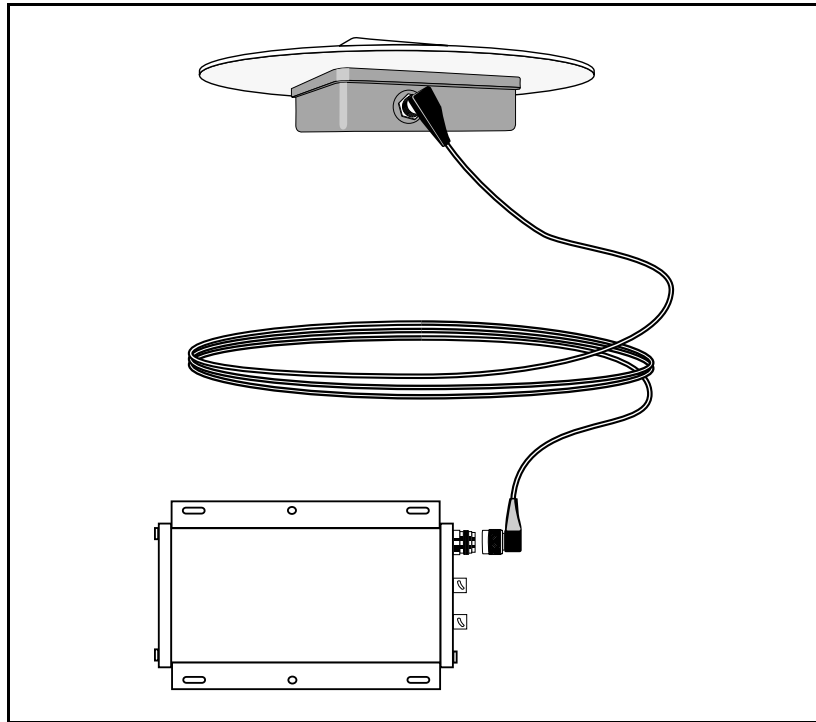

Figure 7-3 Antenna Cable Connections

After routing the cable, connect it to the MS750 receiver. Use tie-wraps to secure the cable at several points along the route. One tie-wrap is highly recommended to secure the cable near the base of the antenna. This provides strain relief for the antenna cable connection.



Note – When securing the cable, start at the antenna and work towards the MS750 receiver.

When the cable is secured, coil any slack. Secure the coil with a tie-wrap and tuck it in a safe place.

7.1.8 Connecting Power and External Devices

After installing the MS750 antenna and receiver, connect and route the data/power and data/PPS cables. The MS750 receiver can be powered by a vehicle or customer-supplied 12-32 VDC switched power source. Once the receiver is installed and powered on, the front panel LCD screen light turns on. Figure 7-4 shows one possible scheme for connecting interface devices and peripherals to the MS750 receiver.

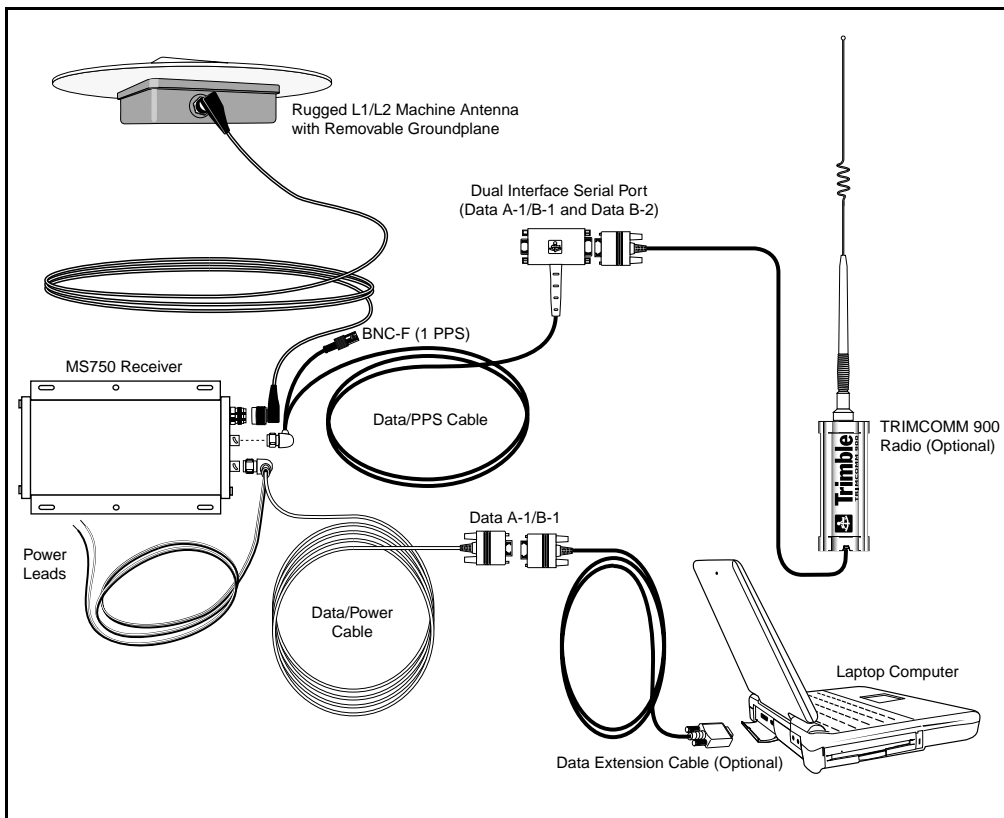

Figure 7-4 One Possible Cable Connection Scheme

Connecting the Data/Power Cable

The data/power 12/24 VDC cable (P/N 30945) features power leads for connecting a 12 VDC power source to the MS750 receiver and an RS-232 connector for connecting an external device to Serial Port A or Serial Port B-1. Figure 7-4 shows a laptop computer connected to Serial Port A. For cable pin-out information, see Data/Power Cable, page 7-71.



Warning – Power should only be applied to one port, not both.



Note – Port A is the only serial port capable of supporting RTS/CTS flow control negotiation.

To connect the MS750 receiver to a power source and external device:

1. Connect the CONXALL right-angle connector of the data/power cable to the connector labeled Port A or Port B on the MS750 receiver.
2. Connect a laptop computer or another serial interface device to the DB9 connector (Serial Port A or B-1).



Note – Optionally, the RS-232 connection can be extended by installing the 3.6 meter data extension cable (P/N 30700) between the interface device and the DB9 connector on the data/power cable.

3. Connect the red power lead to the +12-32 volts supply and the black lead to ground.
4. Coil excess slack and secure the interface cable and power leads.

Connecting the Data/PPS Cable

The data/PPS cable (P/N 37382) features a dual serial interface with two DB9 connectors for attaching serial devices to Serial Port B-1 and B-2 and a 1 PPS cable. The cable may also be used on Port A to access Serial Port A. For cable pin-out information, see Data/PPS Cable, page 7-72.

To connect the MS750 receiver to serial devices:

1. Connect the CONXALL right-angle connector to the connector labeled Port A or Port B on the MS750 receiver. Figure 7-4 shows the cable attached to the Port B connector.
2. Connect one or two (on Port B connector only) serial devices to the dual DB9 connector on the data/PPS cable. The DB9 connectors for the two serial ports are labeled 'Data A/B-1' and 'Data B-2'. Figure 7-4 shows a Trimble TRIMCOMM 900 radio connected to one of the DB9 connectors (for example, a source for differential data).



Note – The MS750 receiver is compatible with all Trimble survey-grade radios, including the TRIMCOMM 900, TRIMMARK II Base/ Repeater and Rover, TRIMTALK 450, TRIMTALK 450S, and TRIMTALK 900. The TRIMCOMM 900 is recommended for its superior throughput and performance.



Note – Optionally, the RS-232 connection for serial ports A or B-1 can be extended by installing the 3.6 meter data extension cable (P/N 30700) between the interface device and the DB9 connector on the data/PPS cable. The data extension cable cannot be used to extend the serial port B-2 connection.



Note – Ports B-1 and B-2 do not support RTS/CTS flow control negotiation. Serial devices requiring RTS/CTS flow control negotiation should be connected to Port A using the data/power cable.

3. Optionally, connect the BNC-F connector on the 1 PPS cable to an external device for 1 PPS output.
4. Coil excess slack and secure the cable.

7.1.9 Completing the Installation

The MS750 receiver must be configured before the unit can be operated. The three serial ports (Ports A, B-1, and B-2) must be configured to operate with the interface devices and peripherals connected to the receiver. Key receiver operating parameters must also be set to custom configure the unit for the precise positioning application. For detailed instructions, see *Configuring the MS750 Receiver*, page 7-36.

7.2 Getting Started

This section shows you how to:

- Use the keypad on the front panel
- View the *Utility*, *GPS*, *DGPS*, *RTK*, and *Receiver Status* screens

We recommend you read through this chapter to learn basic skills before attempting to use the MS750 receiver.

7.2.1 Using the Front Panel

After powering on the MS750 receiver, the front panel displays the *Home* screen. When operating the receiver Trimble recommends that this screen be in view. Figure 7-5 shows the keypad and front panel.

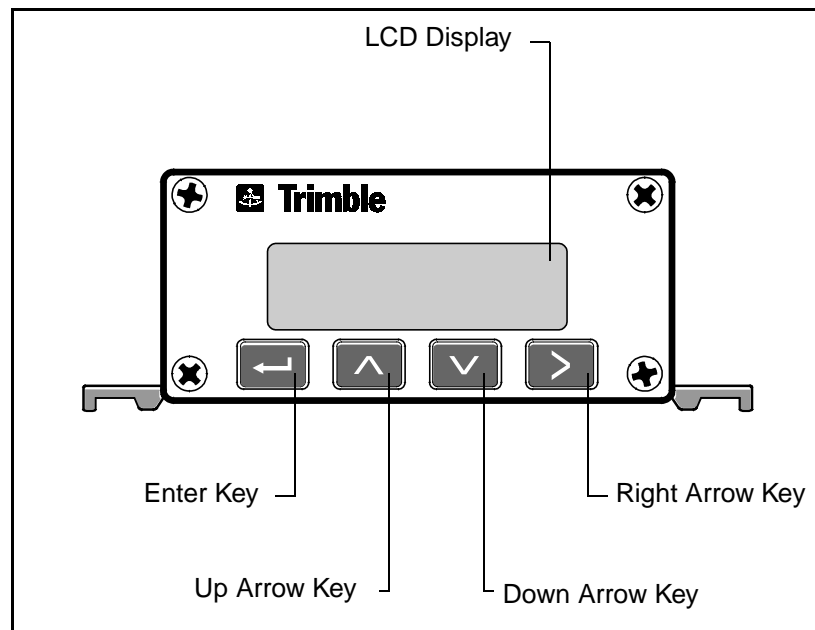

Figure 7-5 MS750 Receiver Front Panel

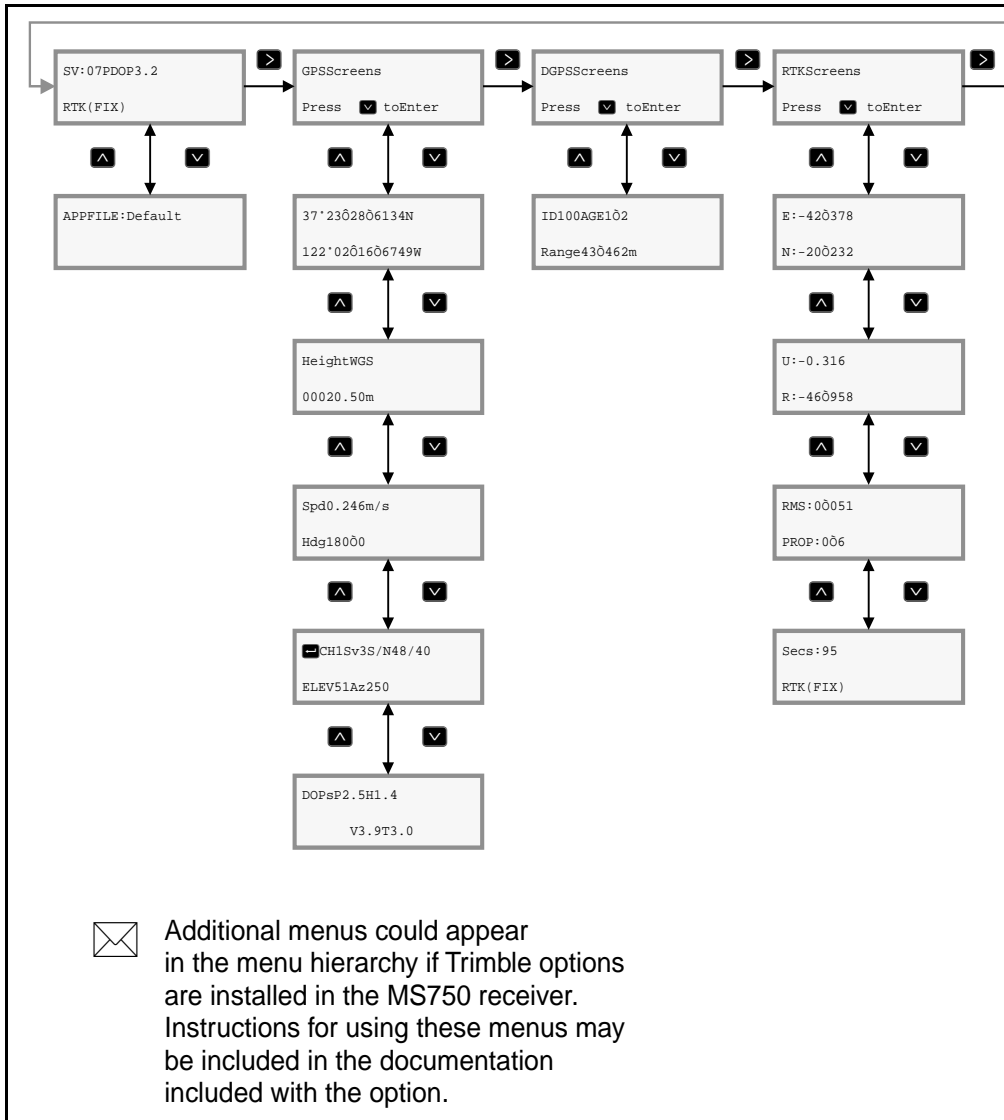

Figure 7-6 MS750 Status Screen Hierarchy

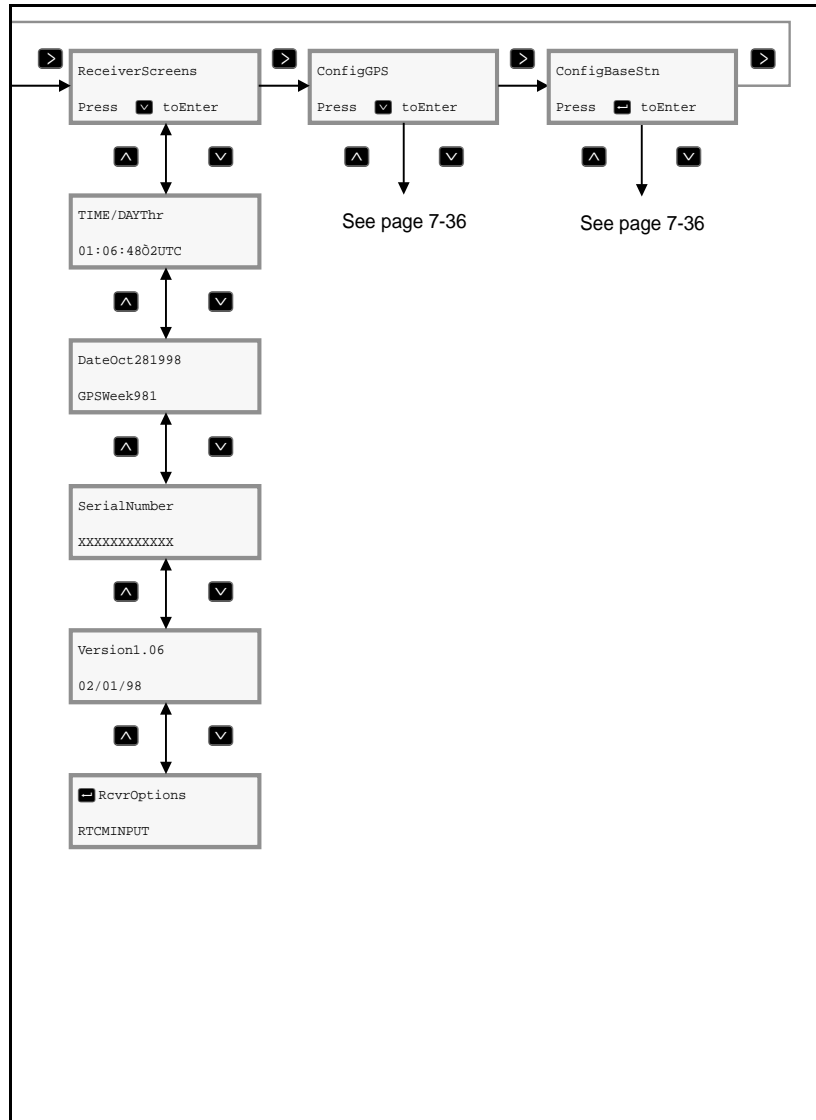









Figure 7-6 MS750 Status Screen Hierarchy (Continued)

Viewing Status Screens

The four keys on the keypad, shown in Figure 7-5, let you navigate through the MS750 menu hierarchy, see Figure 7-6.

Table 7-3 describes the actions performed by the keys.

Table 7-3 Keypad Actions

Key	Description
	Press  to cycle through the options displayed on a screen. When options are available, the  symbol appears in the upper-left corner of the screen.
	Cycles through the available screens.
	Cycles through the available screens.
	Moves through the main menu screens.
 + 	Returns you to the <i>Home</i> screen. <ul style="list-style-type: none"> • When in a view screen described in this chapter, returns you to the <i>Home</i> screen. • When in a configuration screen described in <i>Configuring the MS750 Receiver</i>, page 7-36, returns you to the main menu configuration screen. Press again to return to the <i>Home</i> screen.

7.2.2 The Home Screen

The *Home* screen is the first option in the main menu. The top line of the *Home* screen displays important GPS status indicators. The bottom line displays position type.

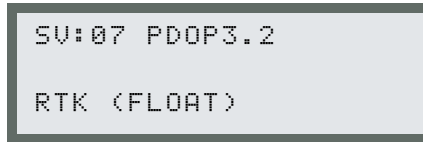

Figure 7-7 explains the GPS status indicators appearing on the top line of the LCD display.

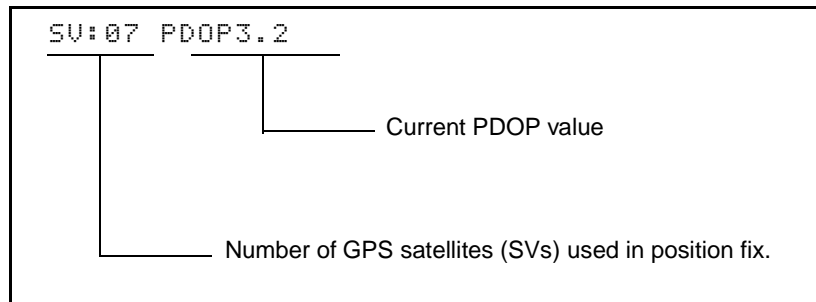



Figure 7-7 GPS Status

Table 7-4 describes the messages you may see displayed on the lower line of the LCD display.

Table 7-4 Home Screen Messages, Lower Line

Indicator	Description
OLD POSITION	Insufficient satellites for valid fix.
AUTONOMOUS	Autonomous positions (100 meter accuracy)
RTK(FLOAT)	Real-time Kinematic solution with Float ambiguities (<1 meter accuracy)
RTK(FIX)	Real-time Kinematic solution with fixed ambiguities (<3 cm accuracy)
DGPS	Code Differential positions (<1 meter accuracy)

AppFile

To view the current application file (see Application File on page 7-44), press .







```
APPLFILE: Default
```

7.2.3 Contrast

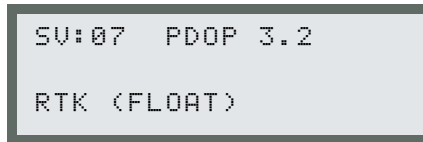
As lighting conditions change, the LCD display could become difficult to read. Contrast can be increased or decreased as follows:

1. Display the *Home* screen.
2. Press  (top left square flashes).



3. Press  to increase contrast.
4. Press  to decrease contrast.
5. Press  to enter contrast.

7.2.4 GPS Status Screens

To view the status of the GPS information from the *Home* screen, press **>** until *GPS Screens* appears. Press **▼** to view the available screens.

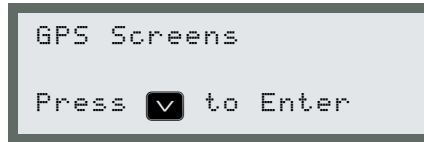

Location

Figure 7-8 explains the following *Location* screen.

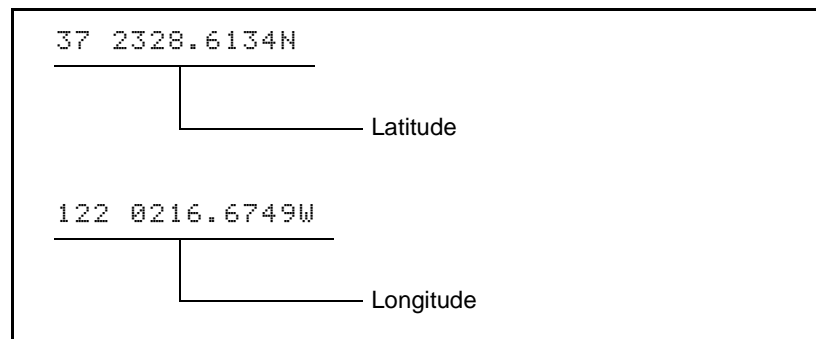
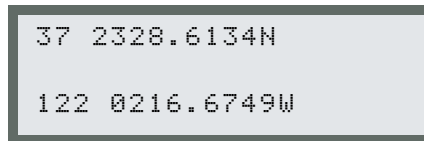

Figure 7-8 Location

Height

Figure 7-9 explains the following *Height* screen.

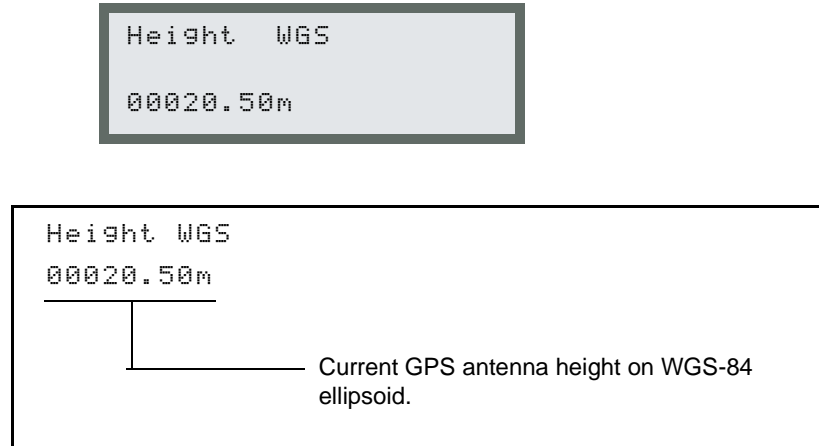

Figure 7-9 Height

Velocity

Figure 7-10 explains the following *Velocity* screen.

```
SPd 0.246 m/s
Hdg 180.0
```

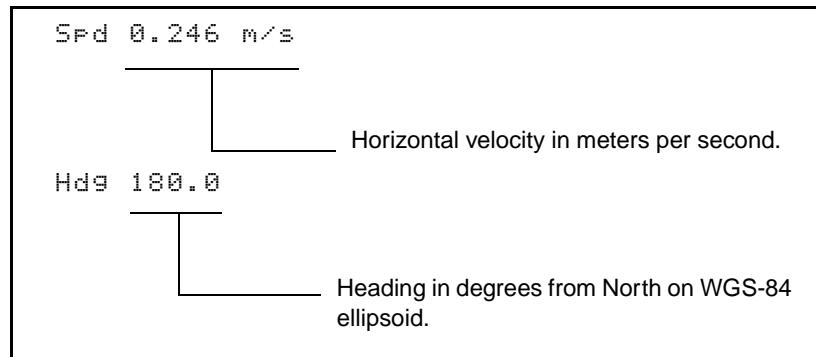

Figure 7-10 Velocity

GPS Satellite Information

Figure 7-11 explains the following *GPS Satellite Information* screen.

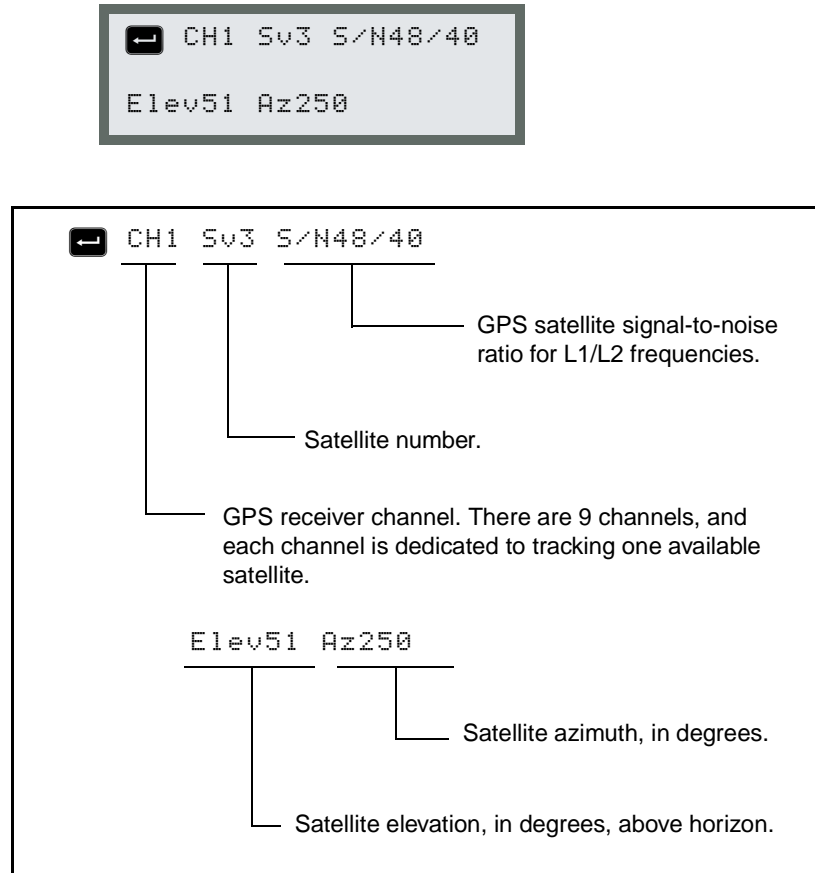

Figure 7-11 GPS Satellite Information

DOPs

Figure 7-12 explains the following *DOPs* screen.

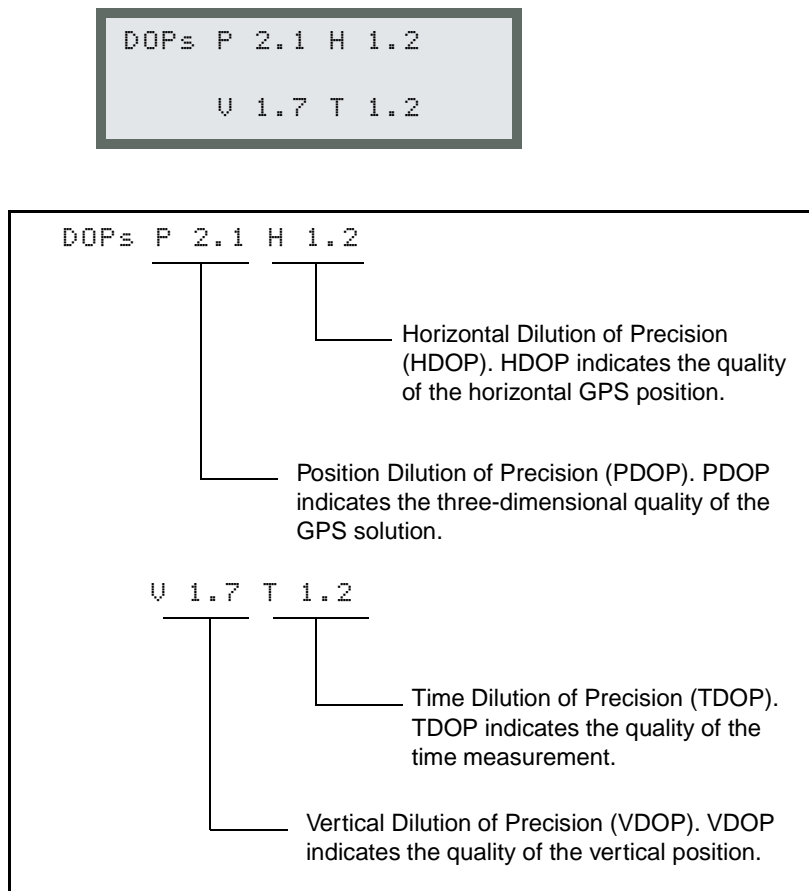

Figure 7-12 DOPs

When viewing DOP information, lower numbers are better. For a description, see Number of Visible Satellites on page 1-22.

Press to return to the *Main* menu.

7.2.5 DGPS Status Screens

To view the status of the DGPS information from the *Home* screen, press **>** until *DGPS Screens* appears. Press **▼** to move to the *DGPS* screen.

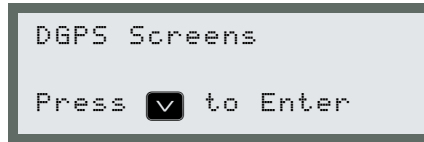

DGPS Info

Figure 7-13 explains the following *DGPS Info* screen.

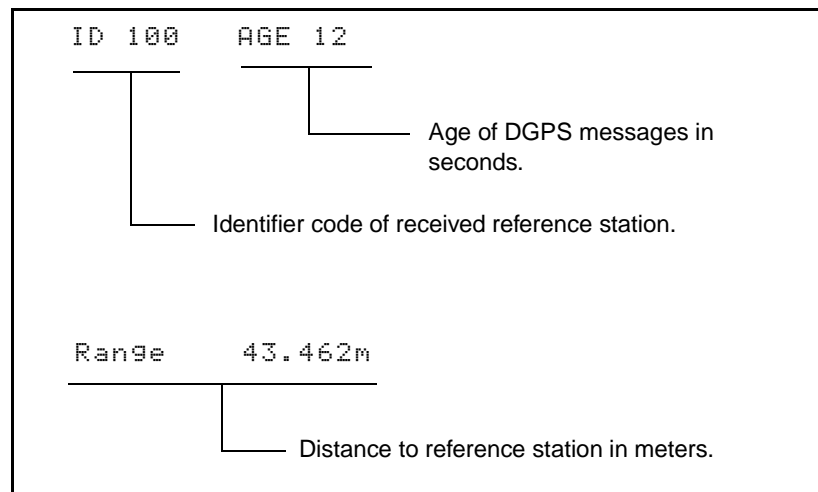
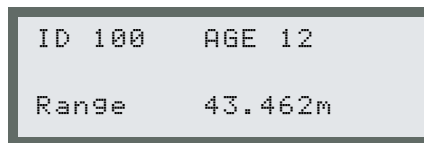
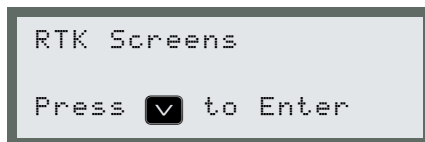

Figure 7-13 DGPS Info

7.2.6 RTK Status Screens

To view the status of the RTK information from the *Home* screen, press **>** until the *RTK Screens* appears. Press **▼** to move through each screen.



Horizontal Vector Information

Figure 7-14 explains the following *Horizontal Vector Status* screen.

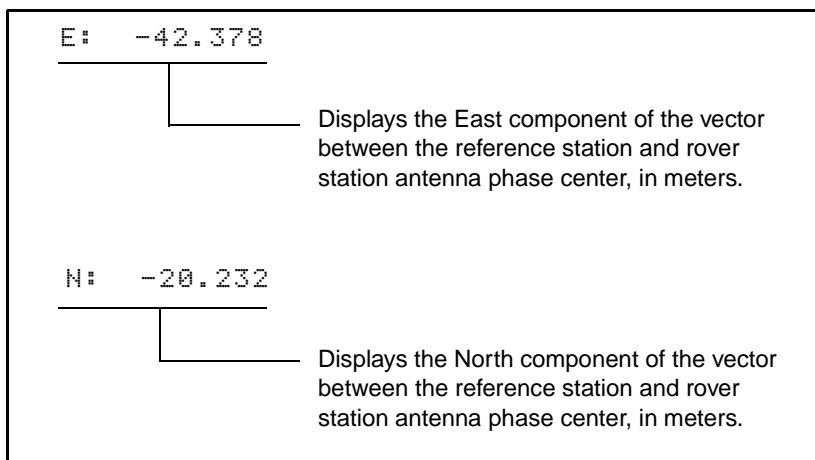
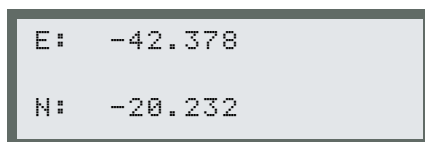
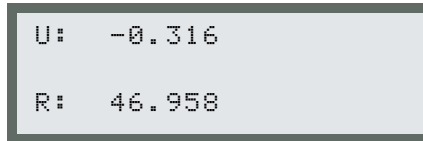

Figure 7-14 Horizontal Vector Status

Vertical and Length Vector Information

Figure 7-15 explains the following *Vertical and Length Vector* screen.



```
U:  -0.316
R:  46.958
```

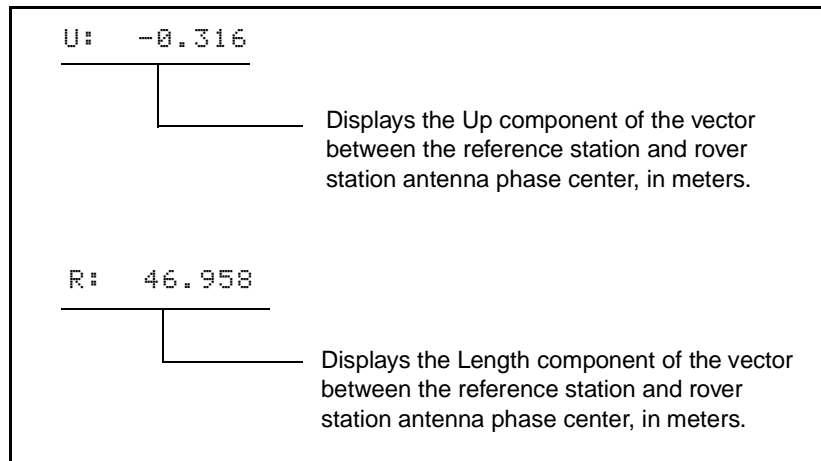
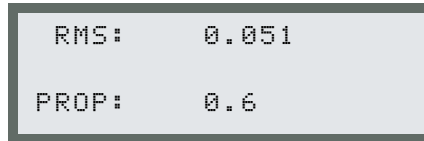

Figure 7-15 Vertical and Length Vector Information

RMS and PROP Information

Figure 7-16 explains the following *RMS* and *PROP* screen.



```
RMS:    0.051
PROP:    0.6
```

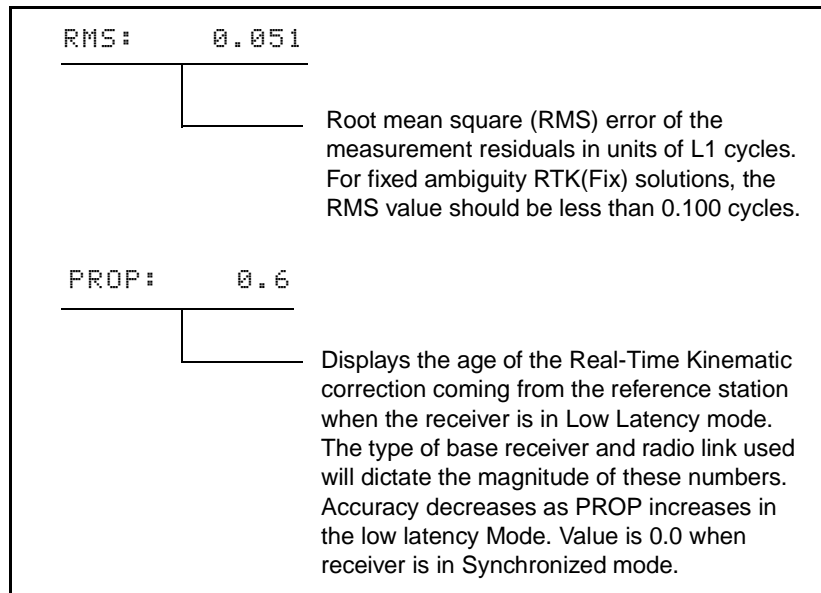

Figure 7-16 RMS and PROP Information

Counter and Messages

Figure 7-17 explains the following *Counter and Messages* screen.

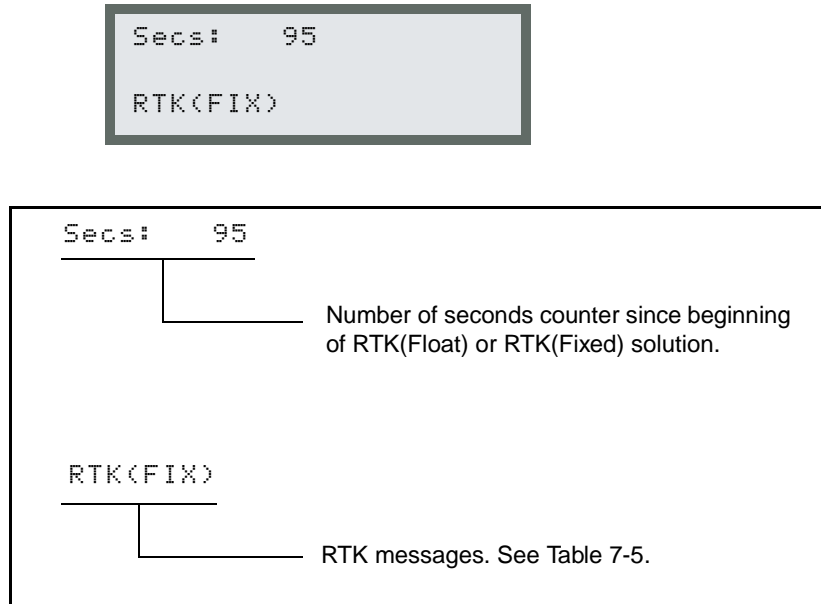

Figure 7-17 Counter and Messages

Table 7-5 RTK Messages

Message	Description
UNKNOWN	Unknown error condition
< MIN SVS	Need more satellites to compute position fix
HIGH DOP	Dilution of Precision exceeds mask value
SYNC'D DATA	Need synchronized data between reference station and rover receiver
NO REF DATA	Not receiving valid data from reference station
NEED REF POS	Waiting for valid reference position message from reference station

Table 7-5 RTK Messages (Continued)

Message	Description
COMMON SVS	Less than 4 common satellites between reference station and rover receivers
C/P MISMATCH	Reference and rover receivers are tracking different types of code measurements
DIFF PDOP	Differential DOP value exceeds mask value
NO L2 PHASE	Need L2 phase data to start ambiguity search process
POOR RMS	RMS figure is considered too high
NO SEARCH	Ambiguity search has not been started
VERIFY FAIL	Ambiguities failed the verification process
# SVS < MIN	Need at least 5 common satellites to start search
HIGH RMS	Search cancelled due to high RMS
LOW RATIO	Search cancelled due to low ratio
PROP CANCEL	Search cancelled because it took too long
HIGH SRH DOP	Search satellites have poor geometry – cannot resolve integers
RF LINK DOWN	No reference station data received
RTK(FLOAT)	RTK with Float ambiguities
RTK(FIX)	RTK with Fix ambiguities

Date and GPS Week

Figure 7-19 explains the following *Date and GPS Week* screen.

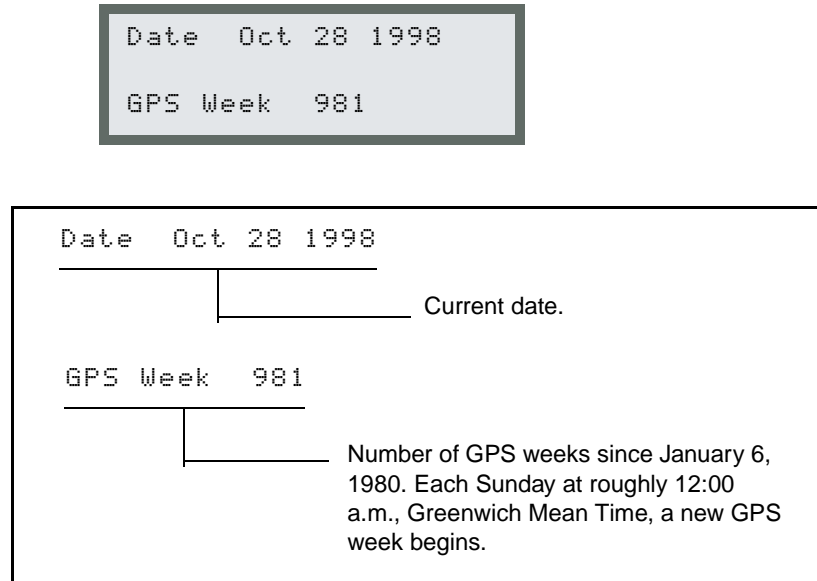

Figure 7-19 Date and GPS Week

Receiver Serial Number

Figure 7-20 explains the following *Receiver Serial Number* screen.

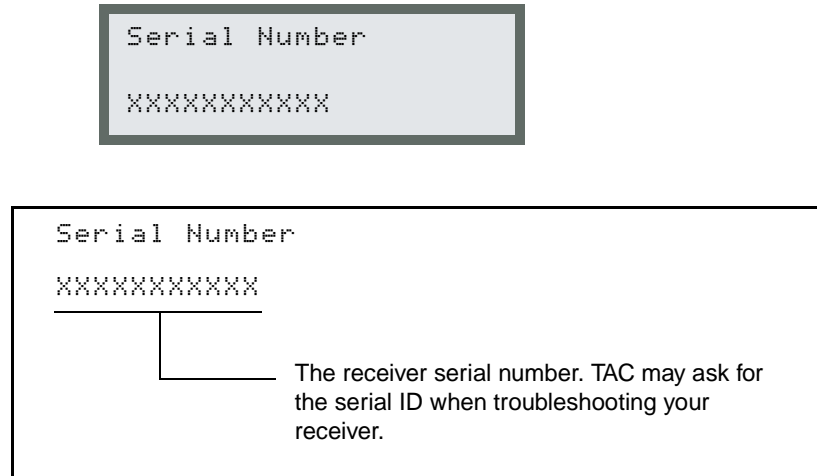

Figure 7-20 Receiver Serial Number

Firmware Version and Release Date

Figure 7-21 explains the following *Firmware Version and Release Date* screen.

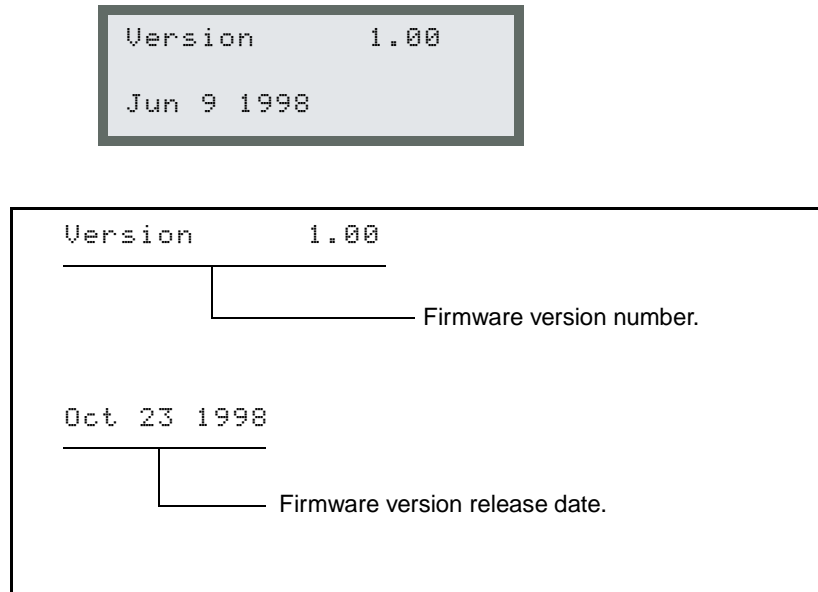
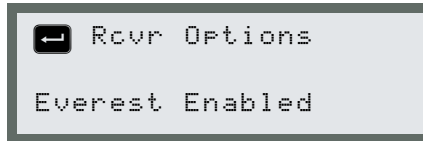

Figure 7-21 Firmware Version and Date

Receiver Options

Table 7-6 describes options available in the *Receiver Options* screen.



Press  to cycle through the available options.

Table 7-6 Receiver Options (Second Line)

Option	Description
20 Hz	20 Hz positioning available.
10 Hz	10 Hz positioning available.
GSO, RT17	Binary raw measurement and data available.
RTCM OUTPUT	Output Base data in RTCM format available.
RTCM INPUT	Receive Base data in RTCM format available.
CMR OUTPUT	Output Base data in Compressed format available.
CMR INPUT	Input Base data in Compressed format available.
CLARION JX1100	Operation with Clarion JX1100 radio.
MOVING BASE RTK	Computation of vector between two moving receivers.

7.3 Configuring the MS750 Receiver

The operating parameters are set to predefined values. These settings are suitable for many different applications and allow the MS750 receiver to be used immediately after installation. You can use the front panel to change configuration parameters for your applications.

The Configuration Toolbox software included with your receiver can also be used to configure the receiver.



Note – Configuration of the local coordinate systems is only possible using the Configuration Toolbox software.

The *Configuration* screen hierarchy is shown in Figur e7-22.

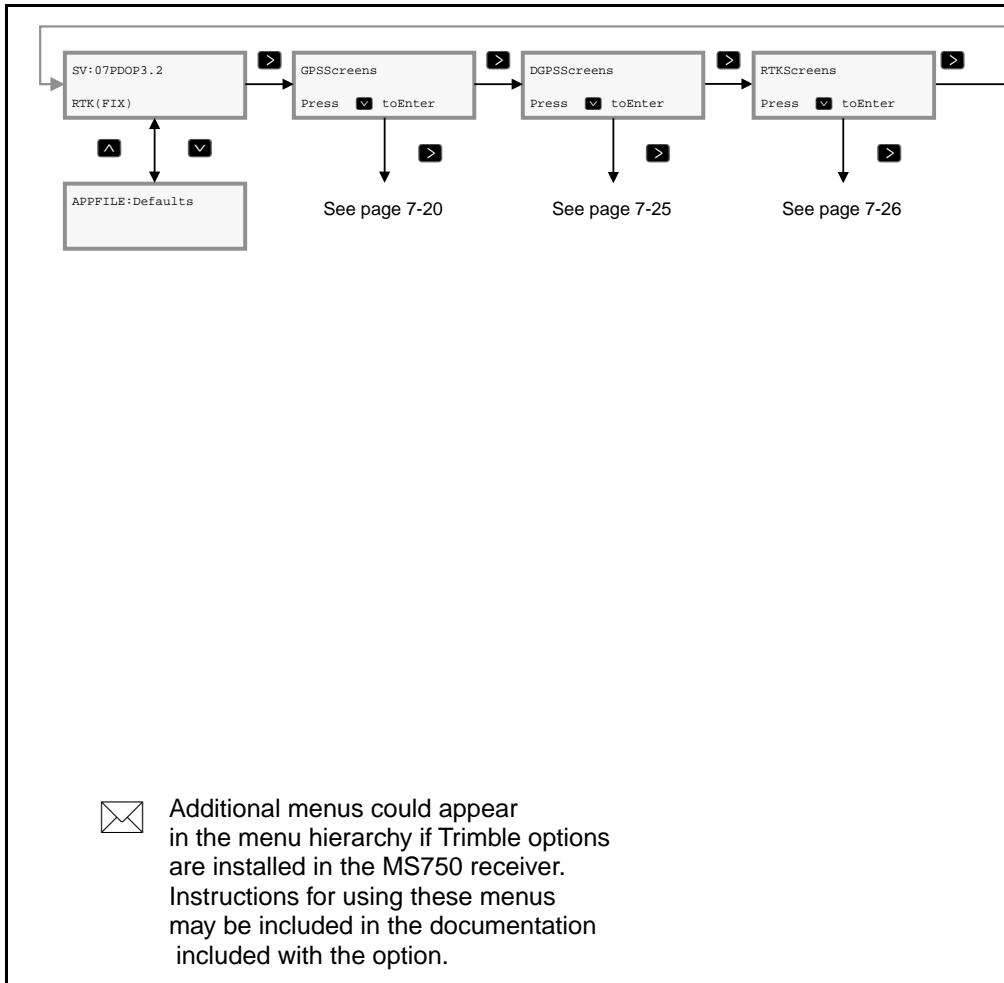

Figure 7-22 Configuration Screen Hierarchy

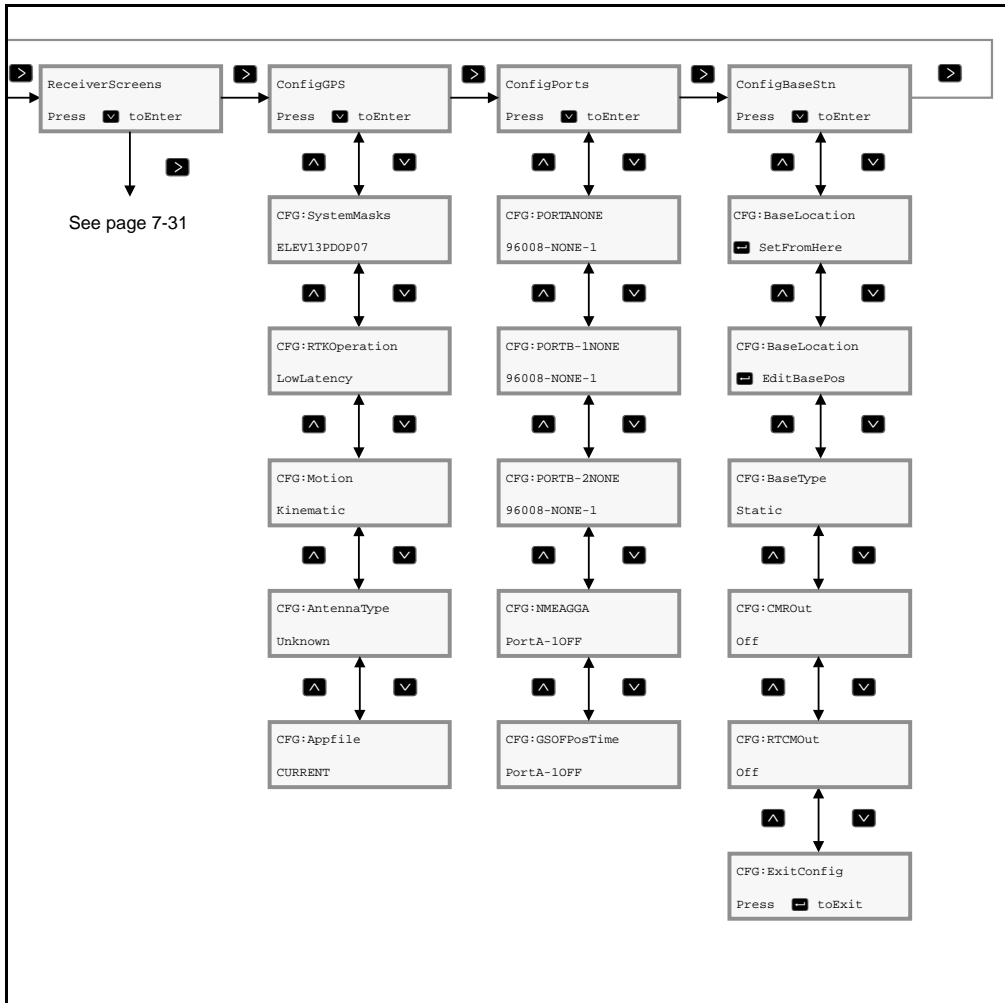











Figure 7-22 Configuration Screen Hierarchy, Continued

7.3.1 Using the Keypad to Change Configuration Settings

In the configuration menus, the keypad contains more functions than when navigating through the *Status* screens. For more information, see Viewing Status Screens, page 7-16.

1. On the *Main* menu, move to a *Configuration* screen and press  to cycle through the *Configuration* screens.
2. Press  to activate the configurable options. The first setting option flashes.
3. Press  or  to cycle through the available settings. If there are multiple settings on a single screen, press  to activate the next setting.
4. When all settings are complete, press .
5. Press  to display the next *Configuration* screen.
6. At the end of the available configuration screens, press  to exit. Alternatively, you can press the  and  keys simultaneously at any time to exit.

7.3.2 GPS Configuration

GPS configuration screens determine how the MS750 receiver computes position data. To display the main menu *GPS Configuration* screen:

1. Display the *Home* screen.
2. Press  until the main menu *Config GPS* screen appears.

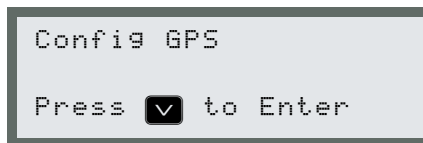

3. Press  to cycle through the available screens.

GPS configuration screens are described in the following sections.

System Masks

System masks filter poor satellite data that reduce position accuracy. The Elevation mask determines the lowest elevation, in degrees, at which the MS750 receiver uses a GPS satellite. The PDOP Mask determines how high the PDOP can rise before the receiver stops computing positions. The *System Masks* screen is shown below:

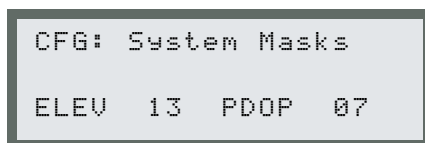

To set the system masks:

1. Press **>** to activate the Elevation Mask. The recommended setting for highest accuracy is 13°. There is a trade-off between accuracy and continuous operation. Lower the elevation mask to ensure continuous operation.
2. Press **>** to activate the PDOP Mask. GPS positions are not output when the PDOP values rise above the PDOP Mask. A low mask (below 7) ensures quality positions are output, but when PDOP rises, no data is available. A high mask (7 and above) may increase the amount of data output, but some data may be less accurate than desired. Raise the PDOP Mask when accuracy is less important than continuous data.
3. Press **←** to save the settings.
4. Press **↓** to advance to more *Config GPS* screens, or press **↑** and **↓** keys simultaneously to return to the main *Config GPS* screen.

RTK Operation

Two modes of operation are available for RTK operation—low latency mode and synchronized mode. Low latency mode delivers low latency positions at rates up to 20 Hz with a small degradation in accuracy. Synchronized mode delivers the highest accuracy position at a maximum update rate of 10 Hz and increased latency. For details about what mode of operation is suitable for your application, see Chapter 1, Overview.

The *RTK Operation* screen is shown below:



To set the RTK mode of operation:

1. Press **>** to activate RTK Operation.
2. Press **▼** or **▲** to select between Low Latency and Synchronized.
3. Press **←** to save the setting.
4. Press **▼** to advance to more *Config GPS* screens, or press **▲** and **▼** keys simultaneously to return to the main *Config GPS* screen.

Motion State

The MS750 receiver supports two motion states—KINEMATIC and STATIC. Select Kinematic when the receiver is moving. Static mode is automatically selected by the receiver if the unit is configured as an RTK or DGPS reference station.



Note – If the Moving Base RTK option is installed, the MS750 receiver remains in Kinematic mode while configured as a reference station.

The *Motion State* screen is shown below:

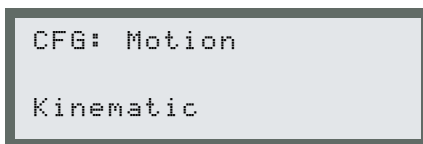

To set the motion state:



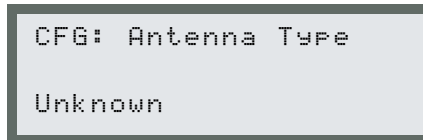

1. Press **>** to activate the *Motion State* screen.
2. Press **▼** or **▲** to select between KINEMATIC and STATIC.
3. Press **←** to save the setting.
4. Press **▼** to advance to more *Config GPS* screens, or press **▲** and **▼** keys simultaneously to return to the main *Config GPS* screen.

Antenna Type

Lets you specify the type of antenna being used. When an antenna is selected other than the default Unknown, the phase bias corrections (<1 cm) are applied to the computed position. The *Antenna Type* screen is shown below:



To set the *Antenna Type*:

1. Press  to activate *Antenna Type* screen.
2. Press  or  to select types of antenna in use.
3. Press  to save the setting.

Application File

All configuration parameter settings are stored within the MS750 receiver in an application file. Up to 10 different application files may be stored in battery-backed memory and may be activated from the *Appfile* screen. CURRENT and DEFAULTS are two application files that always reside in memory. Additional files can be uploaded from the Configuration Toolbox software. The CURRENT file contains the active set (or current) of parameter settings. The DEFAULTS file contains the factory default parameter settings. If any changes are made to the receiver configuration using other screens, then CURRENT is displayed as the application file in operation.

The word ACTIVE follows the Appfile that is in operation.

The *Appfile* screen is shown below:

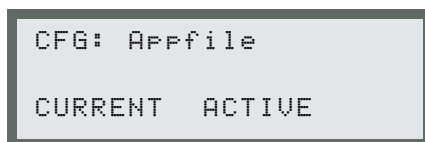

```
CFG: Appfile
CURRENT ACTIVE
```

To select an Application File:

1. Press **>** to activate the *Appfile* screen.
2. Press **▼** or **▲** to scroll through the available application files.
3. Press **←** to activate the displayed application file.
4. Press **▼** to advance to more *Config GPS* screens, or press **▲** and **▼** keys simultaneously to return to the main *Config GPS* screen.

7.3.3 Port Configuration

Ports A, B-1, and B-2 are configured from the Config Ports screens.

To display the *Config Ports* screen:

1. Display the *Main* menu.
2. Press  until the *Config Ports* screen appears.

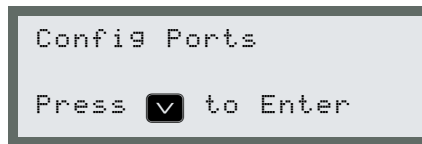

3. Press  to cycle through the screens.

Setting Port Configuration Parameters

The configuration of serial port parameters is identical for the A, B-1, and B-2 ports. The example screens show the configuration of the A port. The Port A configuration screen is shown below and the parameter fields are described in Figure 7-23.

```
CFG: Port A NONE
9600 8-NONE-1
```

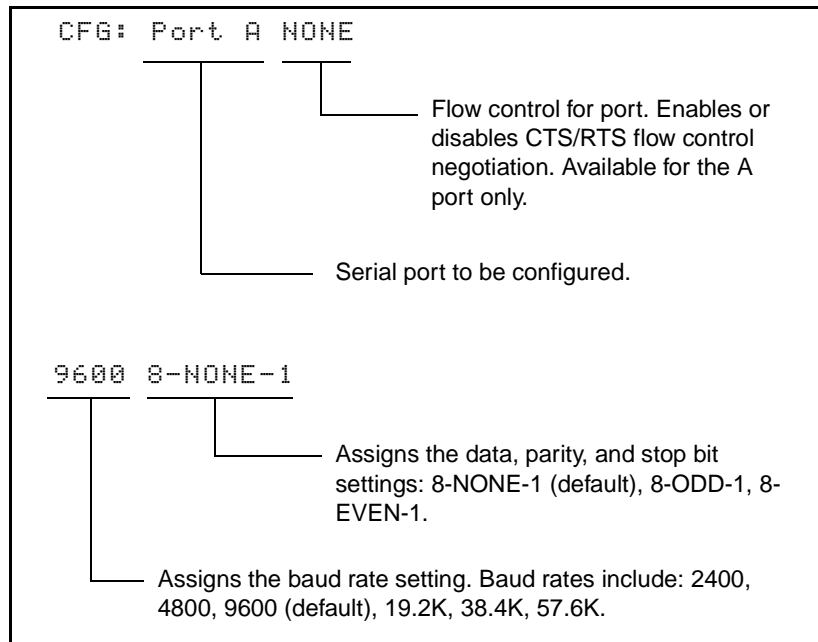









Figure 7-23 Serial Port Setup Fields

To change port settings:

1. Press  to activate screen.
2. To change a field where the cursor is flashing, press  to display the desired option.
3. Press  to advance cursor to the next field and repeat Step 2.
4. When all options are set, press  to enter.
5. Press  to advance to next *Config Ports* screen, or press  and  simultaneously to return to the main *Config Ports* screen.

NMEA Configuration

The *NMEA Configuration* screen is shown below and the parameter fields are described in Figure 7-24.

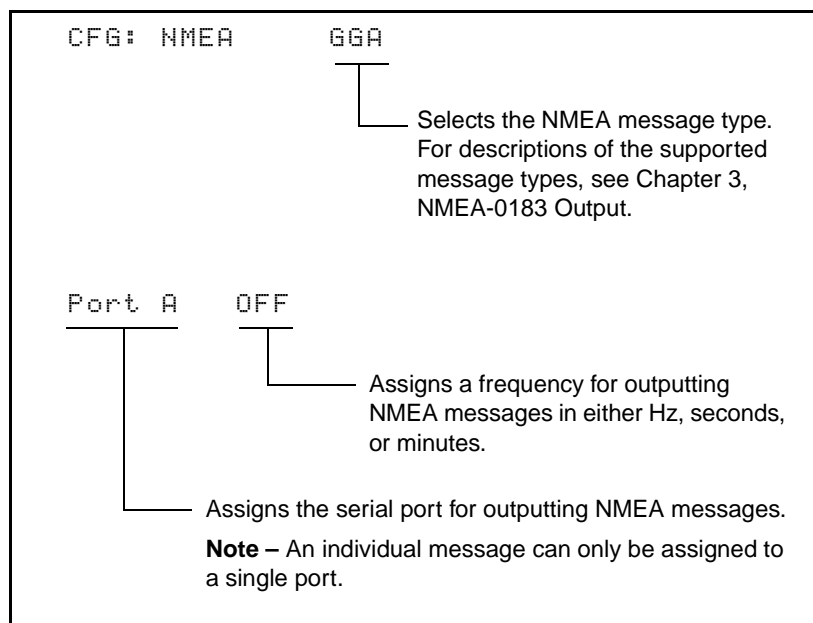
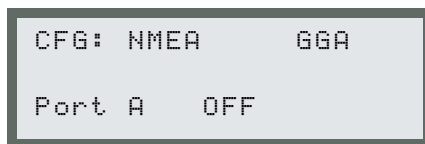









Figure 7-24 NMEA Output Fields

To change NMEA selections:

1. Press  to activate screen.
2. To change a field where the cursor is flashing, press  to display the desired option.
3. Press  to advance cursor to the next field and repeat Step 2.
4. When all options are set, press  to enter.
5. Press  to advance to next *Config Ports* screen, or press  and  simultaneously to return to the main *Config Ports* screen.

GSOF Configuration

The *GSOF Configuration* screen is shown below and the parameter fields are described in Figure 7-25.

```
CFG: GSOF Pos Time
Port A   OFF
```

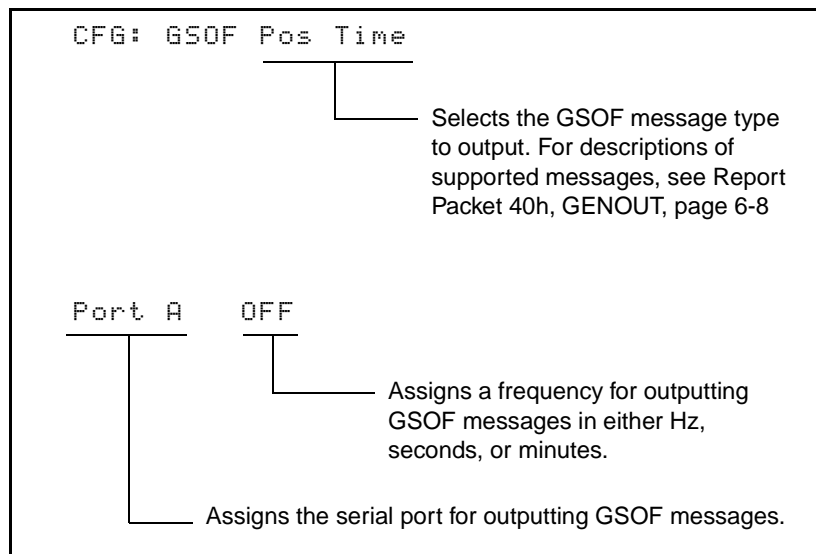









Figure 7-25 GSOF Output Fields

To change GSOF selections:

1. Press  to activate screen.
2. To change a field where the cursor is flashing, press  to display the desired option.
3. Press  to advance cursor to the next field and repeat Step 2.
4. When all options are set, press  to enter.
5. Press  to advance to next *Config Ports* screen, or press  and  simultaneously to return to the main *Config Ports* screen.

7.3.4 Base Station Configuration



Note – The base station configuration screens are only required if you are using the MS750 receiver as a reference station. Use the base station configuration screens to specify the base station position and output type.

When the MS750 receiver is used as a reference station, it outputs either CMR or RTCM data to a customer-supplied radio solution. The radio then broadcasts the CMR or RTCM data to other receivers in the field.

A reference position consisting of WGS-84 latitude, longitude, and height above ellipsoid is required when using the MS750 receiver in base mode. This position can be obtained within seconds by using the Here function, or the information may be manually input. In general, the most precise information available should be used when specifying the reference position. The Here position is an autonomous position, and it is recommended when no other position information is available (see Critical Factors Affecting RTK Accuracy, page 1-20).

Once a reference position is supplied, the MS750 receiver can begin generating CMR or RTCM data. CMR data is the recommended output for RTK positioning, or applications where centimeter-level positions are required. RTCM data is recommended when the MS750 receiver is used as a DGPS reference station or in applications where a combination of RTK and DGPS rovers are operating.



Use the base station configuration screens to specify the base station position and output type.

To display the main menu *Base Station Configuration* screen:

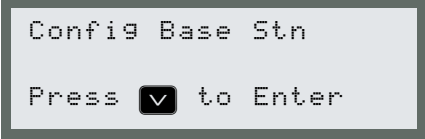
1. Display the *Main* menu.
2. Press  until the *Base Stn Config* screen appears.



```
Config Base Stn
Press [down arrow] to Enter
```

3. Press . Press  to cycle through the screens (see Figure 7-26).

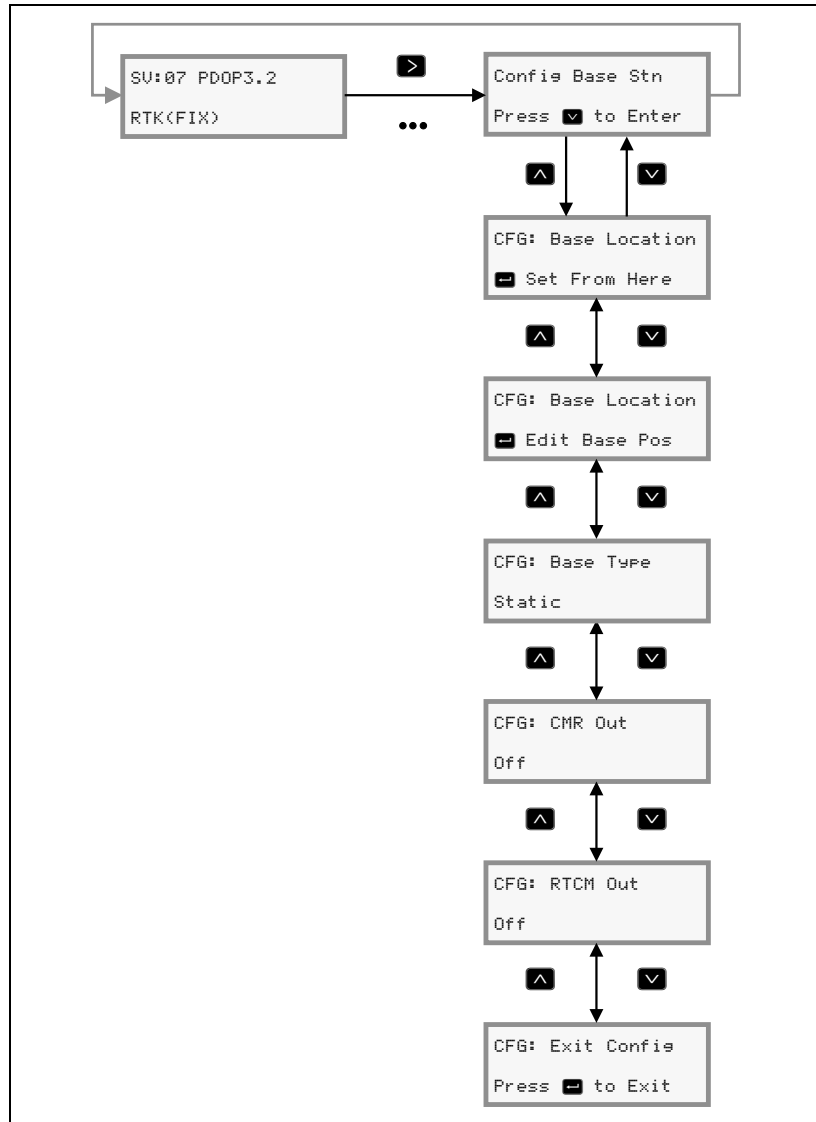
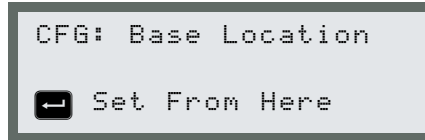

Figure 7-26 Config Base Station Screen Hierarchy

Base Location

The *Base Location* screen is used to set and edit the reference station coordinates. *Set From Here* is used to enter an autonomous position. *Edit Base Position* is used to manually enter coordinates. The *Base Location* screen is shown below:



Note – Reference coordinates are provided in Latitude, Longitude, and Height Above the WGS84 Ellipsoid.











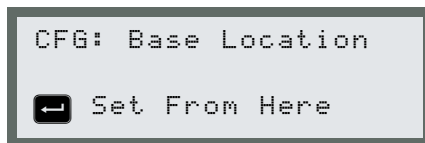



Note – A position set from 'Here' is an autonomous position. To enter known coordinates, use the *Edit Base Position* screens.

Set From Here

To set the reference position, based on an autonomous position:

1. From the *CFG: Base Station* screen, press  to display:











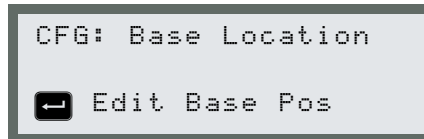

2. Press . The receiver displays three successive screens showing your latitude, longitude, and height. Two types of operations can be performed from each screen:
 - To save the reference coordinate, press .
 - To change a value, press  to move the blinking cursor to the field of interest. Press  or  to change the value. Move to the next field by pressing . When all characters are correct, press  to save the changes and advance to the next option.
3. After pressing  to accept the Height value, the receiver asks whether or not to accept the new position. There are two options:
 - To accept the position, press .
 - To reject the position, press  or . Then press .

Edit

To edit the current reference position:

1. From the *CFG: Base Location* screen, press  until the screen reads:



2. Press . The receiver displays three screens showing Latitude, Longitude, and Height fields. In each screen, press  or  at the blinking cursor to change a field. Move to the next field by pressing . Press  to save the changes.
3. After pressing  to accept changes to the Height screen, the receiver asks whether or not to accept the new position. There are two options:
 - To accept the position, press .
 - To reject the position, press  or . Then press .

Configure Base Type

This screen allows selection of either Static or Moving base type. Moving base type is selected when configuring the unit for Moving Base RTK operation (see Moving Base RTK Operation, page 7-64).





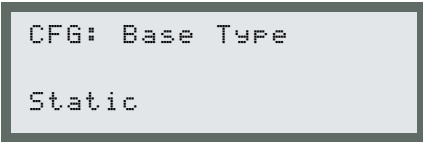

Note – The Moving Base RTK option must be installed in the receiver if you want to select Moving.

1. From the *CFG: Base Location* screen, press  until the following screen appears:



```
CFG: Base Type
Static
```

2. Press  to activate the cursor.
3. Press  or  to select STATIC or MOVING.
4. Press  to save the setting.

Configure CMR Out

To output CMR data, the port and CMR type must be specified. Figure 7-27 shows the screen displays and keys to press when selecting the ports and CMR types.

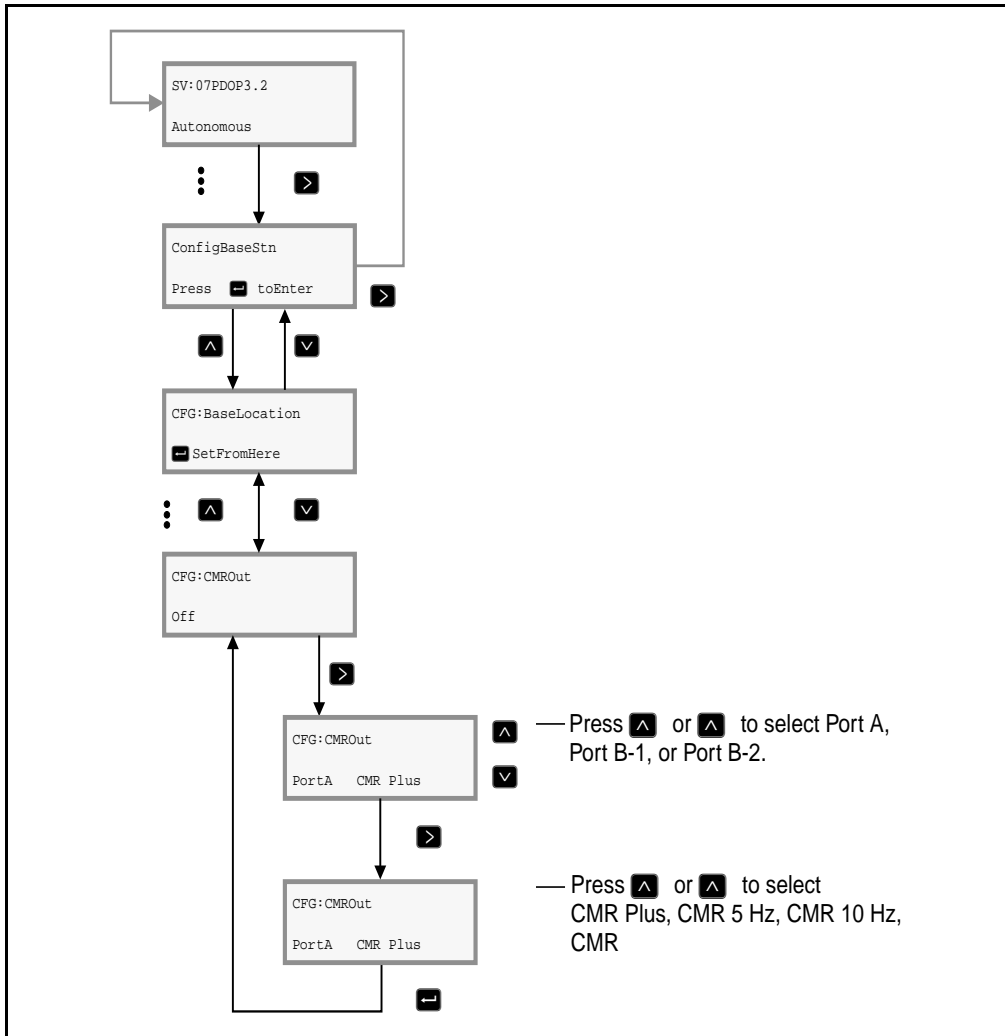



Figure 7-27 CMR Output

To select the CMR port and CMR type:

1. From the *CFG: Base Location* screen, press  until the following screen appears:

```
CFG: CMR Out
Off
```

2. Press  to activate the cursor.

```
CFG: CMR Out
Port A CMR Plus
```





3. Press  until you see the desired port. The options are Port A, Port B-1, or Port B-2. With the cursor blinking on the desired port, press  to move to the CMR type field.
4. Press  until you see the desired CMR type (see Table 7-7).

Table 7-7 CMR Types

Option	Description
CMR Plus	Outputs base data at a 1 Hz rate for RTK applications using the MS750, Series 7400, or 4400 receivers.
CMR 5Hz	Required for 5 Hz Synchronized RTK and higher accuracy Low Latency positioning (see RTK Positioning Modes, page 1-11).
CMR	Required for applications where roving receivers include Trimble 4000 series

5. With the correct port and type selected, press  to accept.



Tip – If the receiver is used for different applications, the port output parameters must be configured each time to make sure the proper data type is output.

RTCM Output

To output RTCM data, the port and RTCM type must be specified. Figure 7-28 shows the screen displays and keys to press when selecting the ports and RTCM types.

Note – If RTK data only is required, then CMR output type is recommended.

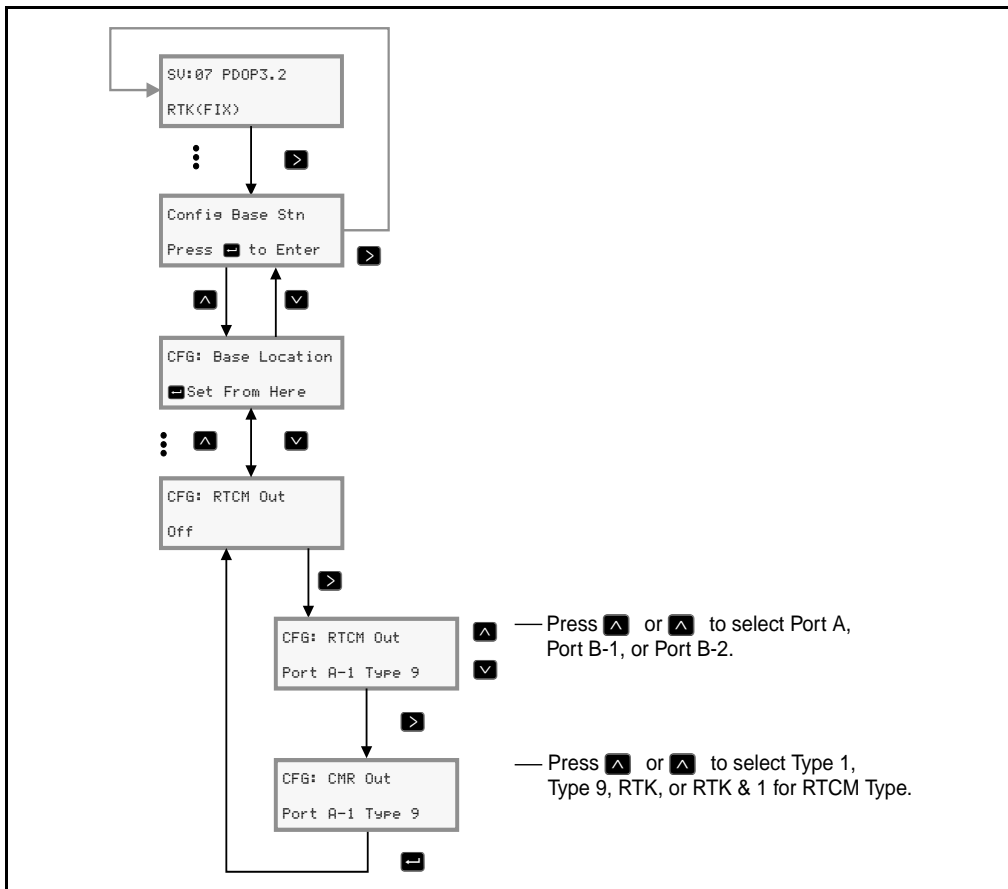



Figure 7-28 RTCM Output

To configure RTCM Output:

1. From the *CFG: Base Location* screen, press  until the following screen appears:

```
CFG: RTCM Out
Off
```

2. Press  to activate the cursor and display the following screen:

```
CFG: RTCM Out
Port A Type 1
```





3. Press  until you see the desired port. The options are Port A, Port B-1, or Port B-2.
4. With the cursor blinking on the desired port, press  to move to the RTCM type field.
5. Press  until you see the desired RTCM type (see Table 7-8).

Table 7-8 RTCM Types

Option	Description
Type 1	DGPS corrections
Type 9	DGPS corrections
RTK	RTK data only
RTK & 1	RTK and Type 1 combined

6. With the correct port and type selected, press  to accept.
- When all base station settings have been selected, press  to accept and exit the base station configuration menus.

7.4 Moving Base RTK Operation



Note – Check to see that you have the Moving Base RTK option installed in the receiver before continuing (Firmware Option 38325-00).

Read page 1-16 for an overview of the Moving Base RTK technique. There are two ways to configure your receiver for Moving Base operation:

- wireless
- cabled

Your application determines which method you choose. If the moving base receiver and a moving rover receiver are on different platforms separated by a radio data link, then use the first method. But if both receivers are located on a common platform and can be connected by cable, then use the second method.

7.4.1 Wireless Method

With this configuration CMR measurements are sent from the base to the rover via radio. The computed baseline results are output from the rover using VGK and VHD, see NMEA Messages, page 3-4.

1. On the moving base receiver configure the CMR output base type to MOVING.
2. The moving rover receiver automatically switches to Moving Base RTK mode.
3. Baseline results can be output using NMEA messages VGK and VHD.

7.4.2 Cabled Method

With this configuration the two receivers are connected by cable between any two serial ports. After switching on either NMEA *AVR* messages or Streamed Output *ATTITUDE INFO* messages from the moving base, the base receiver automatically sets up the following:

- CMRs at 10 Hz are sent between base and rover
- the rover calculates the vector between the two
- this vector is passed back to the base and output in the selected attitude message.



Note – The base receiver can also compute and output RTK positions calculated relative to a static base.

7.5 MS750 Specifications

The following tables list specifications for the MS750 receiver..

Table 7-9 MS750 Receiver

Size	14.5 cm W x 5.1 cm H x 23.9 cm D (5.7 in. W x 2.0 in. H x 9.4 in. D)
Weight	1.0 Kg (2.25 lb.)
Power	9 Watts (max), 12–24 VDC
Operating Temperature	–20°C to +60°C (–4°F to +140°F)
Storage Temperature	–30°C to +80°C (–22°F to +176°F)
Humidity	100% condensing, unit fully sealed
Casing	Dust proof, shock resistant

Table 7-10 Positioning Specifications

Positioning	Mode	Latency	Accuracy²	Max Rate
RTK (OTF)	Synchronized	>100MS	1 cm + 2 ppm (times baseline length) Horizontal 2 cm + 2 ppm (times baseline length) Vertical	10
	Low Latency	<20MS	2 cm + 2 ppm (times baseline length) Horizontal ¹ 3 cm + 2 ppm (times baseline length) Vertical ¹	20
L1 C/A Code Phase	Synchronized /Low Latency	<20MS	Horizontal – 50 cm Vertical – 75 cm	20
1 Depends on radio link latency.				
2 One sigma figure of merit, varies with S/A errors and satellite geometry.				

Table 7-11 MS750 Technical Specifications

Tracking	9 channels L1 C/A code, L1/L2 full cycle carrier. Fully operational during P-code encryption.
Signal Processing	Maxwell architecture; very low-noise C/A code processing; multipath suppression
Start-up	Cold Start: <90 seconds from power on Warm Start: <30 seconds with recent ephemeris
Initialization	Automatic while moving or static
Time Required	Typically <1 minute to initialize
Range	Up to 10 km
Communications	Three RS-232 serial ports (Port A, Port B-1, and Port B-2). Baud rates up to 115,200. RTS/CTS flow control negotiation supported on Port A only.
Configuration	Configuration of receiver via user definable application files
Output Formats	NMEA-0183: GGA; GST; GSV; PTNL,GGK; PTNL,GGK_SYNC; PTNL,PJK; PTNL,PJT; PTNL,VGK; VHD; VTG; ZDA GSOF (Trimble Binary Streamed Output) 1 PPS

7.6 MS750 Cables and Connectors

The tables in this section give pin-out information for the MS750 receiver standard and optional cables. This information can be used to prepare special cables for interfacing the MS750 receiver with devices and instruments not supported by the *standard* and optional cables.

7.6.1 Port A and Port B Connectors

Figure 7-29 identifies the MS750 Port A connector pin locations. The pin locations for the Port B connector are identical.

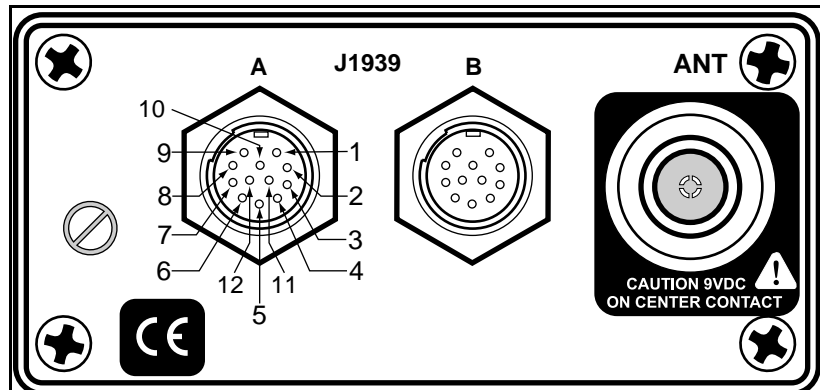

Figure 7-29 Port A Connector Pin Locations

Port A Connector Pin-out Diagram

Figure 7-30 gives pin-out requirements for the connector labeled Port A.

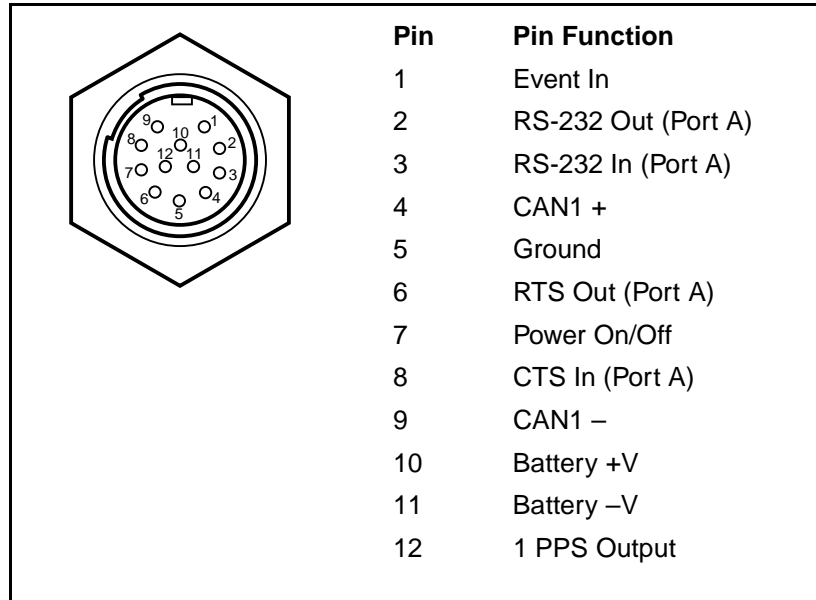

Figure 7-30 Port A Connector Pin-out

Port B Connector Pin-out Diagram

Figure 7-31 gives pin-out requirements for the connector labeled Port B.

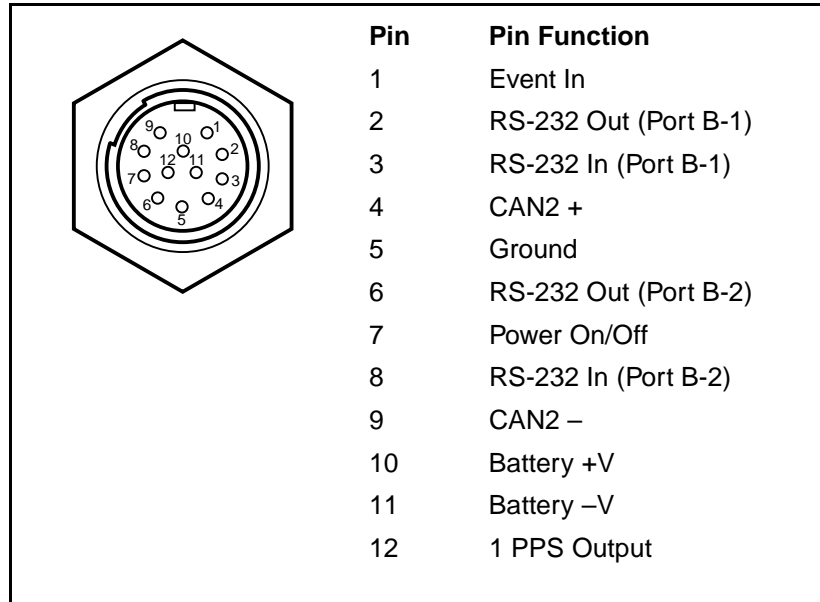

Figure 7-31 Port B Connector Pin-out

7.6.2 Data/Power Cable

Table 7-12 gives pin-out information for the data/power cable (P/N 30945) included with the MS750 receiver.

Table 7-12 Data/Power Cable Pin-out (P/N 30945)

CONXALL Connector		Direction	DE9-F Connector			Power Leads	
12 Pin			7 Cond			2 Cond	
Pin	Signal		Pin	Color	Signal	Color	Signal
1	EVENT IN	←	4	—	DTR		
2	TXD	→	2	ORN	RXD		
3	RXD	←	3	BLU	TXD		
4	CAN +	←	—	—	—		
5	SIG GND	↔	5	SHIELD	SIG GND		
6	RTS/TXD	→	8	YEL	RTS		
8	CTS/RXD	←	7	GRN	CTS		
9	CAN –	→	—	—	—		
7	PWR ON	←				RED	V+ IN
10	V+ IN						
11	V– IN	←				BLK	V– OUT
12	PPS	→	9	BLU	PPS		



Note – Table 7-12 assumes that the cable is attached to the connector labeled Port A. When the data/power cable is attached to the connector labeled Port B, pin 6 is used for serial port B-2 TXD and pin 8 is used for serial port B-2 RXD.

7.6.3 Data/PPS Cable

Table 7-13 gives pin-out information for the data/PPS cable (P/N 37382) included with the MS750 receiver. The data/PPS cable is used with the MS750 connector labeled Port B only. The A/B-1 designation in the Signal column refers to serial port A or B-1 and B-2 refers to serial port B-2.

Table 7-13 Data/PPS Cable Pin-out (P/N 37382)

CONXALL Connector		Direction	DE9-F Connector (Port A/B-1)		DE9-M Connector (Port B-2)		BNC-F Connector (1 PPS)
12 Pin			5 Cond		5 Cond		2 Cond
Pin	Signal		Pin	Signal	Pin	Signal	Signal
1	EVENT IN	←					
2	A/B-1 TXD	→	2	RXD			
3	A/B-1 RXD	←	3	TXD			
4	CAN +	←	—	—	—	—	PPS -
5	SIG GND	↔	5	SIG GND	5	SIG GND	
6	B-2 TXD	→			3	TXD	
8	B-2 RXD	←			2	RXD	PPS +
9	CAN -	→	—	—	—	—	
7	PWR ON	←					
10	V+ IN						
11	V- IN	←					
12	PPS	→					

7.6.4 Data Extension Cable

Table 7-14 gives pin-out information for the optional data extension cable (P/N 30700).

Table 7-14 Data Extension Cable Pin-out (P/N 30700)

DE9-F Connector (P1)		7-Wire Cond Cable		DE9-M Connector (P2)	
Pin	Signal	Color	Direction	Pin	Signal
1	EVENT IN	WHT	→	1	CD
2	TXD	ORN	←	3	RXD
3	RXD	RED	→	3	TXD
4	CHG CTRL	BLK	→	4	—
5	SIG GND	SHIELD	↔	5	SIG GND
6	DSR	YEL	←	6	DSR
7	PWR ON	BRN	→	7	RTS
8	CTS	GRN	←	8	CTS
9	CHARGE	BLU	←	9	RI



Note – The data extension cable can only be used to extend the cable length for serial ports A and B-1.

7.7 GPS Antennas and Cables

The antenna that a receiver uses to collect satellite signals is sometimes called a GPS antenna to distinguish it from a radio antenna used for communication between receivers and external networks or systems (a cable connection between the MS750 receiver and a radio unit for receiving RTCM corrections).

The MS750 receiver is connected to its antenna through the Type N connector labeled ANT. A coaxial cable with a Type N plug at the antenna end is used.

For antenna cable lengths of 15 meters (45 feet) or less, RG-58 cable can be used. For cable lengths over 15 meters, RG-213 cable must be used. For cable lengths over 30 meters (100 feet), an in-line amplifier, semi-rigid coaxial cable, or other low-loss cable assembly must be used.

7.8 1 PPS Time Strobe and Time Tag

The MS750 receiver can output a 1 pulse/second (1 PPS) time strobe and an associated time tag on the Port A or Port B connectors. The time tags are output on a user-selected serial port.

The leading edge of the pulse coincides with the beginning of each UTC second. The pulse is driven by an RS-422 driver between nominal levels of 0.0V and 4.0V, see Figure 7-32. The leading edge is positive (rising from 0V to 4V).

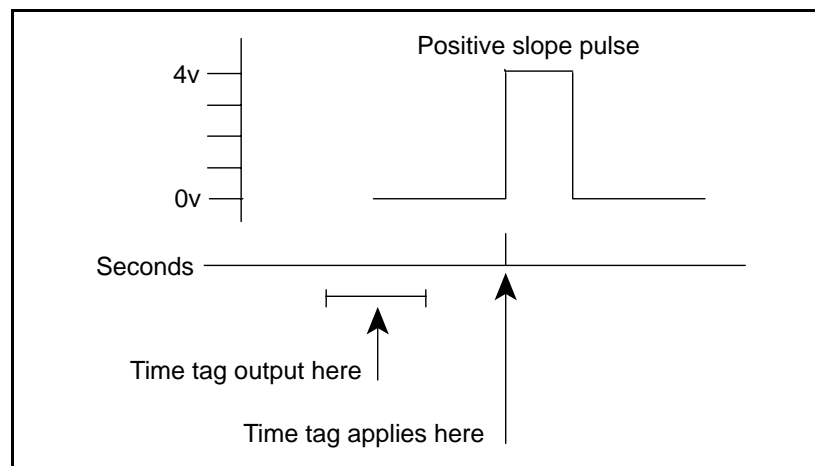

Figure 7-32 Time Tag Relation to 1 PPS Wave Form

The pulse is about 1 msec wide, with rise and fall times of about 100 nsec. Resolution is approximately 40nsec, but several external factors limit accuracy to approximately ± 1 msec:

- **Selective Availability:** When in effect, introduces errors of up to 30 meters (100 nsec) in satellite signals, with corresponding errors in the 1 PPS pulse.
- **Antenna cable length:** Each meter of cable adds a delay of about 2 nsec. to satellite signals, and a corresponding delay in the 1 PPS pulse.

Each time tag is output about 0.5 second before the corresponding pulse. Time tags are in ASCII format on a user-selected serial port. The format of a time tag is:

UTC *yy.mm.dd hh:mm:ss ab*

Where:

- UTC is fixed text.
- *yy.mm.dd* is the year, month, and date.
- *hh:mm:ss* is the hour (on a 24-hour clock), minute, and second. The time is in UTC, not GPS.
- *a* is the position-fix type:
 - 1 = time only
 - 2 = 1D & time
 - 3 is currently unused
 - 4 = 2D & time
 - 5 = 3D & time
- *b* is number of satellites being tracked: 1 to 9.
- Each time tag is terminated by a *carriage return, line feed* sequence.

A typical printout looks like:

```
UTC 93.12.21 20:21:16 56
UTC 93.12.21 20:21:17 56
UTC 93.12.21 20:21:18 56
```

a and *b* may be ??, meaning that the time is based on the MS750 clock because the receiver is not tracking satellites. The receiver clock is less accurate than time readings extracted from satellite signals.

You can set up for this configuration by using the following accessory items:

- TSC1 for MS750 - P/N 30000-90
Includes TSC1 data collector with preinstalled Survey Controller software, Lithium-Ion battery, 9v battery adapter, Field Guide, Reference Manual, pouch for TSC1, and MS750-to-TSC1 cable with dual camcorder clips.
- TSC1/MS750 Field & Download Kit with OSM- P/N 39297-00
Includes OSMIV charger, 4 x 12V camcorder batteries.
- TSC1/MS750 Download Kit without OSM- P/N 39297-10

8 BD750 Operation

The BD750 receiver delivers the highest performance capabilities of a dual-frequency receiver in a compact, Eurocard form factor, Figure 8-1. This section outlines how to begin working with the BD750 starter kit.

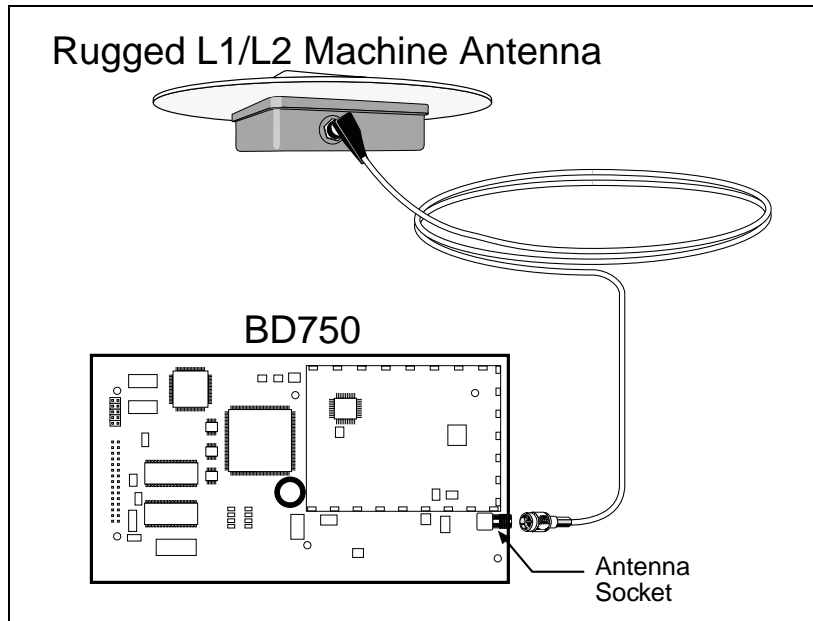

Figure 8-1 BD750 Receiver on Eurocard PC Board

8.1 Getting Started

This section shows you how to:

- Unpack and inspect the shipment
- Install the BD750 receiver
- Install the antenna
- Connect power and install interface devices

We recommend you read this entire section before attempting to install the BD750 receiver.

8.1.1 Unpacking and Inspecting the Shipment

Visually inspect the shipping cartons for any signs of damage or mishandling before unpacking the receiver. Immediately report any damage to the shipping carrier.

Opening the Shipping Carton

The shipment can include one or more cartons, depending on the number of optional accessories ordered. Open the shipping cartons and make sure that all of the components indicated on the bill of lading are present. Table 8-1 identifies the standard components included with the BD750 receiver kit.

Table 8-1 BD750 Starter Kit (39000-00) Components

Qty	P/N	Description
1	39000-10	BD750 Receiver
1	29547	Ribbon Cable
1	39414-10	Test I/O Board
1	40868-00	MS Series Operation Manual
1	38431-10	Remote Controller & Configuration Toolbox Software

The shipment may also include a combination of the options and accessories listed in Table 8-2.

Table 8-2 Options and Accessories

P/N	Description
38159-00	Rugged L1/L2 Machine Antenna
38326-00	Micro-Centered Antenna
23158	Removable Groundplane
14563-10	Type N-to-SMA, 5-meter Antenna Cable
14284	RS-232 Serial Cable

8.1.2 Reporting Shipping Problems

Report any problems discovered after you unpack the shipping cartons to both Trimble Customer Support and the shipping carrier.

8.2 Receiver Installation Guidelines

The BD750 receiver is designed to be either rail mounted or standoff mounted, using appropriate hardware with the six mounting holes provided, see Figure 8-2 and Figure 8-3.

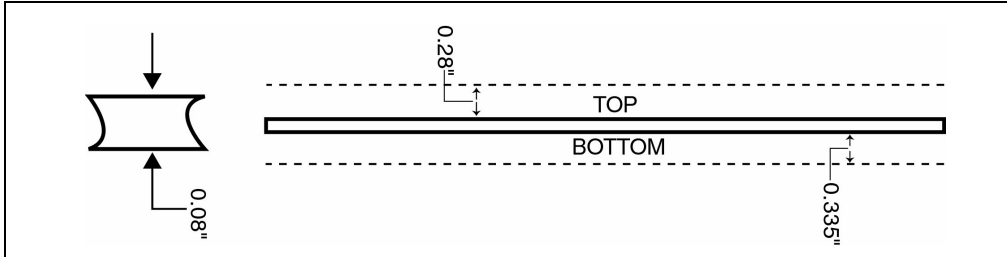

Figure 8-2 BD750 Edge View

The BD750 receiver should be installed in a location situated in a dry environment. Avoid exposure to extreme environmental conditions, including:

- Water or excessive moisture
- Excessive Heat $> 70^{\circ}\text{C}$
- Excessive cold $< -40^{\circ}\text{C}$
- Corrosive fluids and gases

Avoiding these conditions improves the BD750 receiver's performance and long-term product reliability.

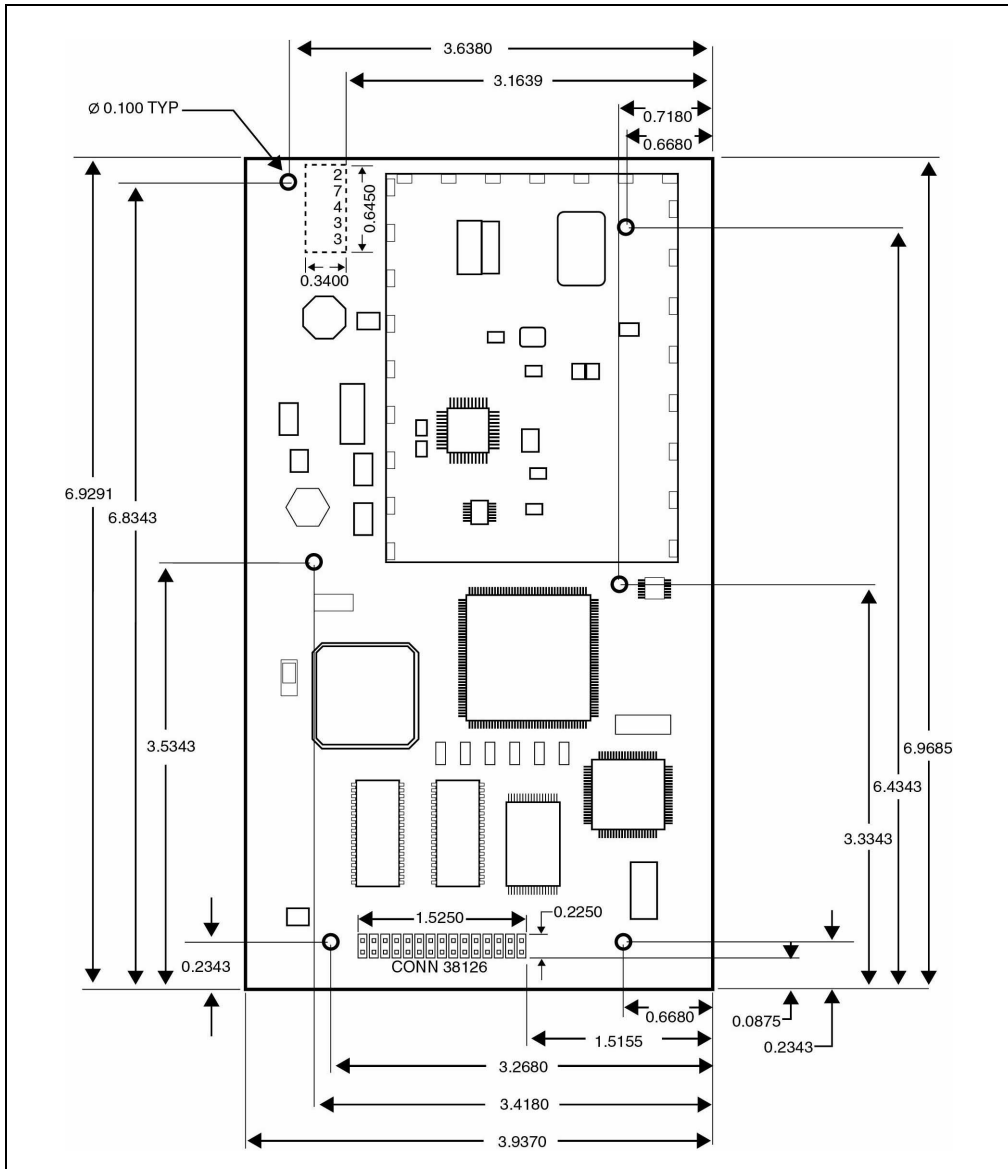

Figure 8-3 BD750 Dimensioned Outline

8.3 Antenna Mounting Guidelines

Choose a location for the antenna that is safe from damage during normal operation. Observe the following guidelines when selecting the antenna location:

- Place the antenna on a flat surface along the center line of the vehicle, if application is mobile.
- Choose an area with clear view to the sky above metallic objects.
- Avoid mounting the antenna close to stays, electrical cables, metal masts, and other antennas.
- Do not mount the antenna near transmitting antennas, radar arrays, or satellite communication equipment.
- Avoid areas with high vibration, excessive heat, electrical interference, and strong magnetic fields.

8.3.1 Sources of Electrical Interference

Avoid the following sources of electrical and magnetic noise:

- Gasoline engines (spark plugs)
- Televisions and PC monitors
- Alternators and generators
- Electric motors
- Propeller shafts
- Equipment with DC-to-AC converters
- Florescent lights
- Switching power supplies

8.4 BD750 Connections

The BD750 Starter Kit (P/N 39000-00) contains a Test I/O Board and the necessary cabling to provide power and signal interface to the receiver. Figure 8-4 shows the BD750 receiver and the connection scheme with the I/O board and other components.

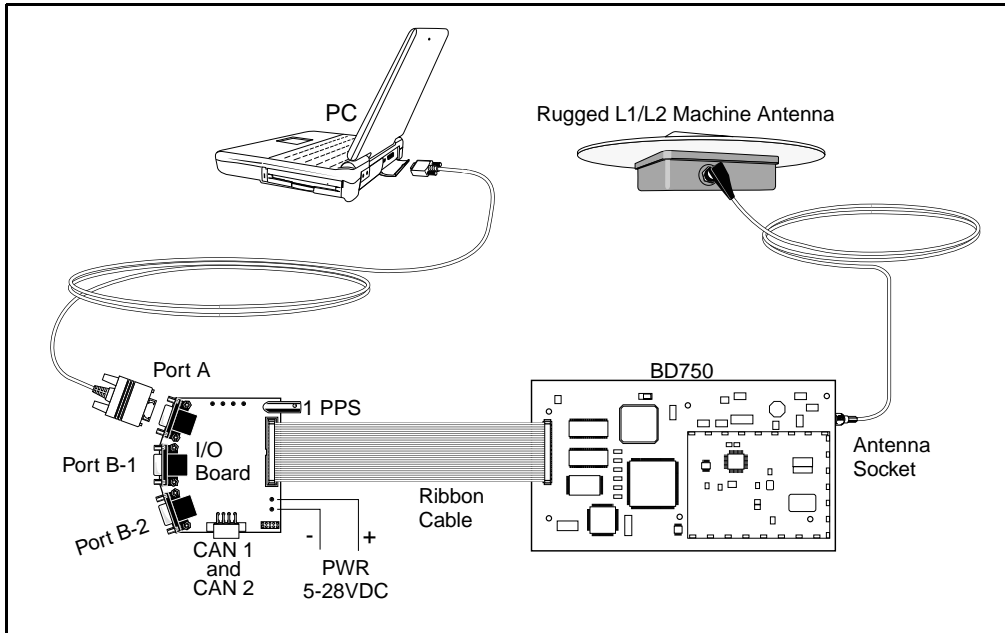

Figure 8-4 Typical BD750 Interconnect

The Port A and Port B connectors provide identical RS-232 ports which can be used as desired. The ribbon cable supplies signal and power to the receiver. The PC computer connection provides means to set up and configure the receiver.

8.4.1 Routing and Connecting the Antenna Cable

After mounting the antenna, route the antenna cable from the GPS antenna to the BD750 receiver (see Figure 8-1). Avoid the following hazards when routing the antenna cable:

- Sharp ends or kinks in the cable
- Hot surfaces (exhaust manifolds or stacks)
- Rotating or reciprocating equipment
- Sharp or abrasive surfaces
- Door and window jams
- Corrosive fluids or gases

After routing the cable, connect it to the BD750 receiver. Use tie-wraps to secure the cable at several points along the route. One tie-wrap is highly recommended to secure the cable near the base of the antenna. This provides strain relief for the antenna cable connection.



Note – When securing the cable, start at the antenna and work towards the BD750 receiver.

When the cable is secured, coil any slack. Secure the coil with a tie-wrap and tuck it in a safe place.

8.5 Configuring the BD750

The BD750 receiver can be set up to operate in either of two ways:

- as a static base station
- as an RTK rover relative to a static base station.

We recommend you read Chapter 2, Receiver Operation Using the Simulated Keypad and Display first, to familiarize yourself with the receiver configuration and status screens.

8.5.1 Communicating With the Receiver

Connect your PC computer to a serial port on the Test I/O board, using a serial cable such as Trimble's P/N 14284. To run the Remote Controller software, refer to Remote Controller Software, page 2-2 which deals with this topic in detail. The main default settings for the BD750 receiver are:

- all serial port outputs are disabled
- all serial ports are configured for 9600 baud, 8 data bits, no parity, and 1 stop bit
- no local coordinates are defined



Note – The MS860 receiver can also be configured using the Configuration Toolbox software, or using the Data Collector Format serial interface.

8.5.2 Static Base Station Configuration

To configure the BD750 receiver as a base station:

1. Click **CONTROL** to display the *Control* screen, then click on the **<BASE STATION>** softkey.
2. Enter the 3D coordinates of the base station. If you do not have the coordinates of the survey point, click on the **<HERE>** softkey.



Note – See Base Station Averaging, page 2-41 for more details about Base Station setup.



Caution – Do not click **CLEAR** until all fields intended to be entered have been verified, as the information will be lost.

3. From the *CONTROL* screen click **ALPHA**, then click on the **<SERIAL PORT OUTPUT>** softkey.
4. Click **<CMR/RTCM OUTPUT>** softkey. Enable either CMR or RTCM message outputs using the instructions for CMR/RTCM OUTPUT Screen on page 2-53.
5. Click **CLEAR** several times to return to the main screen. To verify the outputs are switched ON, click on the **STATUS** key followed by the **<RECEIVER SYSTEMS>** softkey. The mode field should indicate *Base Station*.

8.5.3 Configuring the BD750 as a Rover

To configure the receiver as a rover:

1. Click **CONTROL**, click **ALPHA**, and then click on the **<SERIAL PORT SETUP>** softkey.

Confirm that the serial settings of the receiver's I/O port being used for the correction input are the same as those selected for the radio modem.



Note – The BD750 receiver automatically detects the port used to input corrections. You need to verify that the serial settings are correct.

2. Click **CLEAR** several times to return to the main screen.
3. Click **<POSITION>** and confirm the position type to be *RTK* or *DGPS*, depending on the type of correction data you selected as input for the system.

To enable the output of position and other data strings from the receiver:

1. Click **CONTROL**, click **ALPHA**, and then click on the **<SERIAL PORT SETUP>** softkey to configure the data output.

Confirm that the serial parameters of the receiver I/O ports match the communications parameters selected for the interface device.

2. Click **CLEAR**, and then click on the **<SERIAL PORT OUTPUT>** softkey to choose output type.

For further information on NMEA/ASCII output and streamed output, see page 2-47 and page 2-49. For detailed information about data output formats, see Chapter 3, NMEA-0183 Output or Chapter 6, Data Collector Format Report Packets.

8.6 BD750 Specifications

The following tables list specifications for the BD750 receiver:

Table 8-3 Physical Characteristics

Size	100mm x 177mm x 20mm
Power	+4.75 VDC to +28 VDC (6 Watts)
Connector Details	30 Pin Connector SAMTEC(#HTSW-115-23-S-D-MW) 2 rows of 15 pins on 0.1" centers (Pin 1 has the square solder pad on the back of the board).
Operating Temperature	-40xC to +71xC
Storage Temperature	-40xC to +85xC
Vibration	MIL 810 D, Tailored Random 6.2 gRMS Operating Random 8 gRMS Survival
Mechanical Shock	MIL 810 D ± 40g Operating ± 75g Survival

Table 8-4 30-Pin Connector Pinout

Signal	Pin	Pin	Signal
Power On _ Sample	1	2	N/C
TXD 1	3	4	CTS 1
RXD 1	5	6	RTS 1
CAN 2+	7	8	CAN 2-
DI/O 3	9	10	DI/O 4
CAN 1+	11	12	CAN 1-
TXD 2	13	14	RXD 3
RXD 2	15	16	TXD 3
V-	17	18	V+
V-	19	20	V+
SIGNAL GND	21	22	V+
PPS	23	24	DI/O 2
SPI_MOSI	25	26	SPI_SEL
DI/O 1	27	28	EVENT_IN
SPI_MISO	29	30	SPI_CLK

Table 8-5 Technical Specifications

Tracking	9 channels L1 C/A code, L1/L2 full cycle carrier. Fully operational during P-code encryption.
Signal Processing	Supertrak™ Multibit Technology Everest™ Multipath Suppression
Initialization	Automatic OTF (on-the-fly) while moving
Time Required	Typically <1 minute
Range	Up to 10 km for RTK
Start-up	<90 seconds from power on to positioning <30 seconds with recent ephemeris
Communications	3 x RS-232 ports. Baud rates up to 115,200 1 x SPI port 2 x CAN/J1939
Configuration	Configuration Toolbox, Remote Controller Software or user definable application files
Output Formats	NMEA-0183: GPK, GGA, ZDA, VTG, GST, PJT and PJK Trimble Binary Streamed Output

Table 8-6 Positioning Specifications

Positioning Mode	Accuracy¹	Latency²	Max Rate
Synchronized RTK	1cm + 2ppm Horizontal 2 cm + 2ppm Vertical	300 ms ³	10 Hz
Low Latency	2 cm + 2ppm Horizontal ⁴ 3 cm + 2ppm Vertical	<20ms	20 Hz
DGPS	< 1m	<20ms	20 Hz
¹ 1 sigma level ² At maximum output rate ³ Dependent on data link throughput ⁴ Assumes 1 second data link delay			

9 MS860 Receiver Operation

The MS860 receiver has been designed for application platforms requiring centimeter level absolute positioning together with accurate orientation. The MS860 receiver is a 36 channel L1/L2 GPS receiver with dual antenna inputs, see Figure 9-1.

The rugged construction of the receiver allows it to be installed in almost any environmental conditions.

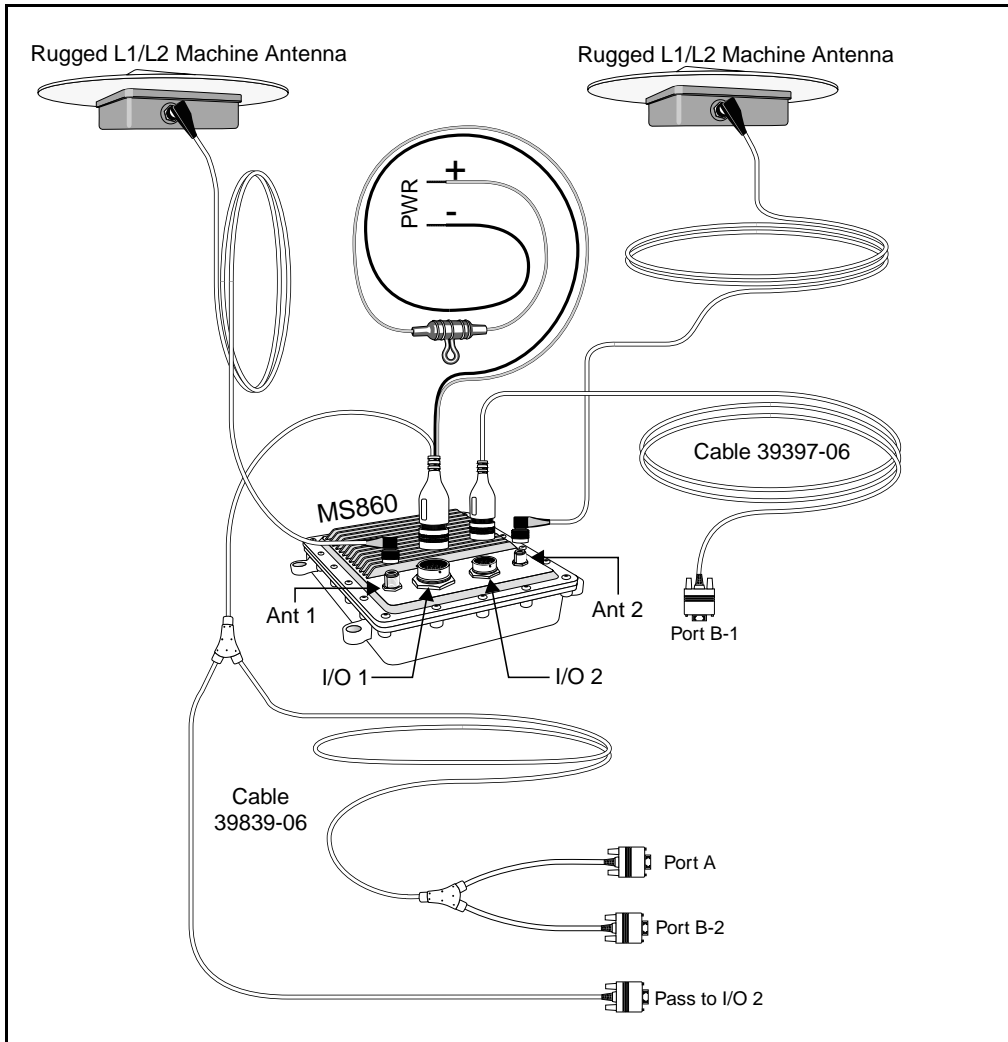

Figure 9-1 MS860 Receiver

9.1 Receiver Architecture

A single GPS receiver such as the MS750 delivers little information on the vehicle heading when the platform is stationary. Heading information is critical when computing offsets from the antenna location to the point of interest. It is also critical when orienting the vehicle on a map display. The technique of Moving Base RTK (see Moving Baseline RTK, page 1-16) provides an accurate vector between two roving receivers.

To reduce the cost and installation difficulties involved with two receivers on each machine, the MS860 receiver was conceived and developed by Trimble. The MS860 receiver contains dual antenna inputs, channel tracking and processing. The master processor computes centimeter level positions relative to a static base in a traditional RTK method.



Note – All user communication with the MS860 receiver is through the master processor.

Once it has been initiated the master processor delivers measurements to the slave processor, for calculation of the Moving Base RTK baseline. This vector result is passed back to the master processor for output to the user.



Note – Moving Base RTK is a synchronized RTK technique and thus involves a small delay relative to low latency RTK positions.

The Moving Base RTK outputs from an MS860 receiver are contained in either the NMEA ASCII string AVR or the binary GSOF message ATTITUDE INFO.

9.2 Installing the MS860 Receiver

This section shows you how to:

- Unpack and inspect the shipment
- Install the MS860 receiver
- Install the antenna
- Connect power and install interface devices

We recommend you read this chapter before attempting to install the MS860 receiver.

9.2.1 Unpacking and Inspecting the Shipment

Visually inspect the shipping cartons for any signs of damage or mishandling before unpacking the receiver. Immediately report any damage to the shipping carrier.

Opening the Shipping Carton

The shipment can include one or more cartons, depending on the number of optional accessories ordered. Open the shipping cartons and make sure that all of the components indicated on the bill of lading are present. Table 9-1 identifies the standard components included with the MS860 receiver.

Table 9-1 MS860 Components

Qty	P/N	Description
1	38920-60	MS860 Receiver
1	39839-06	MS860 I/O 1 Cable
1	39397-06	MS860 I/O 2 Cable
1	40868-00	MS860 Operation Manual
1	38431-10	Configuration Software

The shipment may also include a combination of the options and accessories listed in Table 9-2.

Table 9-2 Options and Accessories

P/N	Description
38159-00	Rugged L1/L2 Machine Antenna
38326-00	Micro-Centered Antenna
23158	Removable Groundplane
17515-01	Type N-to-N, 5-meter Antenna Cable
17515-02	Type N-to-N, 15-meter Antenna Cable
32942-17	9-pin Bendix, 5 meter MS860 to Trimcomm Cable
33980-25	Type N-to-N, Rugged 7.5-meter Antenna Cable
39479-06	MS860 to Trimtalk Cable
33980-99	Type N-to-N, Rugged 30-meter Antenna Cable
41208-00	MS860 Mounting Bracket and Shock Kit

Reporting Shipping Problems

Report any problems discovered after you unpack the shipping cartons to both Trimble Customer Support and the shipping carrier.

9.2.2 Installation Guidelines

The MS860 receiver mounts on a flat surface in any orientation. The receiver features mounting points for securing to a flat surface.



Note – Trimble recommends the use of optional mounting bracket and shock kit, P/N 41208-00.

Choosing a Location

Select a location so that:

- the GPS receiver is not exposed to temperature extremes
- the GPS receiver is not exposed to moisture extremes (rain, snow, water blasters, wash systems)
- the GPS receiver is protected from mechanical damage
- cables can be connected and disconnected without undue stress on them
- cooling fins on the receiver are vertical

Locations that can be used include:

- in a side locker
- behind the operator's chair

Considering Environmental Conditions

Although the MS860 receiver is packaged within a ruggedized housing, one should avoid exposure to extreme environmental conditions, including:

- Water
- Excessive Heat > 70°C (158°F)
- Excessive cold < -40°C (-38°F)
- Corrosive fluids and gases

Avoiding these conditions improves the MS860 receiver's performance and long-term product reliability.

9.2.3 Mounting the Antennas

Choose a location for each antenna that is safe from damage during normal operation. Observe the following guidelines when selecting the antenna location:

- Place the antenna on a flat surface along the center line of the vehicle.
- Choose an area with clear view to the sky above metallic objects.
- Avoid mounting the antenna close to stays, electrical cables, metal masts, and other antennas.
- Do not mount the antenna near transmitting antennas, radar arrays, or satellite communication equipment.
- Avoid areas with high vibration, excessive heat, electrical interference, and strong magnetic fields.



Note – To achieve the best accuracy of the computed heading, provide as much separation distance between antennas as possible.

9.2.4 Routing and Connecting the Antenna Cables

After mounting the antenna, route the antenna cables from the GPS antennas to the MS860 receiver. Avoid the following hazards when routing the antenna cable:

- Sharp ends or kinks in the cable
- Hot surfaces (exhaust manifolds or stacks)
- Rotating or reciprocating equipment
- Sharp or abrasive surfaces
- Door and window jams
- Corrosive fluids or gases

After routing the cables, connect them to the MS860 receiver. Use tie-wraps to secure the cable at several points along the route. One tie-wrap is highly recommended to secure the cable near the base of the antenna. This provides strain relief for the antenna cable connection.



Note – When securing the cable, start at the antenna and work towards the MS860 receiver.

When the cable is secured, coil any slack. Secure the coil with a tie-wrap and tuck it in a safe place.

9.2.5 Connecting Power and External Devices

After installing the MS860 antenna and receiver, connect and route the data/power cables. The following two cables are supplied with the system.

39839-06 Power/Data Cable

This cable provides both unit power and user communications with the receiver on the I/O 1 connector. In addition to bare-wire leads for the DC power supply, the cable contains 3 RS232 ports, terminated in DE9 connectors, which can be connected as follows:

- port A
- port B-2
- pass to I/O 2 connector

The pass to I/O 2 connector allows data from a radio such as the TRIMCOMM to pass directly through to the application.



Note – Port A is the only serial port capable of supporting RTS/CTS flow control negotiation.

39397-06 Data Cable

This cable is used to communicate with the receiver on I/O 2 connector. The DE9 connectors allow communication with port B-1 of the receiver. Data Cable, page 9-20 shows details of the connector pinout. Both DC voltage and signals from I/O 1 are wired in the cable, but not connected at the DE9 termination.

9.2.6 Completing the Installation

The MS860 receiver must be configured before the unit can be operated. The three serial ports (ports A, B-1 and B-2) must be set up to operate with the interface devices and peripheral devices connected to the receiver. Configuring the MS860 to Compute Attitude, page 9-14 details how to configure the unit for precise positioning and attitude.

9.3 Configuring the MS860

This section shows you how to configure the MS860 receiver in two modes:

1. to operate as an RTK rover relative to a static base station;
2. while in mode 1, to simultaneously output attitude information derived from the receiver's dual antennas.

We recommend you read Chapter 2, Receiver Operation Using the Simulated Keypad and Display first, to become familiar with the status screens and configuration of the receiver.

9.3.1 Communicating With the Receiver

Attach a DE9 connector on one of the supplied cables to the PC on which you can run the Remote Controller software.



Note – The MS860 receiver can also be configured using the Configuration Toolbox software, or using the Data Collector Format serial interface.

The main default parameters for the MS860 receiver are:

- All serial port outputs disabled
- All serial ports set for 9600 baud, 8 data bits, no parity and 1 stop bit
- No local coordinates defined

9.3.2 Configuring the MS860 as a Rover

To configure the receiver as a rover:



Caution – Click **[CONTROL]**, click **[ALPHA]**, and then click on the **<SERIAL PORT SETUP>** softkey.

1. Confirm that the serial settings of the receiver's I/O port being used for the correction input are the same as those selected for the radio modem.



Note – The MS860 receiver automatically detects which port is used to input corrections. You need to verify that the serial settings are correct.

2. Click **[CLEAR]** several times to return to the main screen.
3. Click **<POSITION>** and confirm the position type to be *RTK* or *DGPS*, depending on the type of correction data you selected as input for the system.

To enable the output of position and other data strings from the receiver:

1. Click **[CONTROL]**, click **[ALPHA]**, and then click on the **<SERIAL PORT SETUP>** softkey to configure the data output.

Confirm that the serial parameters of the receiver I/O ports match the communications parameters selected for the interface device.

2. Click **[CLEAR]**, and then click on the **<SERIAL PORT OUTPUT>** softkey to choose output type.

For further information on NMEA/ASCII output and streamed output, see page 2-47 and page 2-49. For detailed information about data output formats, see Chapter 3, NMEA-0183 Output or Chapter 6, Data Collector Format Report Packets.

9.3.3 Configuring the MS860 to Compute Attitude

Default operation is for the MS860 receiver to operate as a single antenna system.



Note – The receiver cannot begin to compute its internal Moving Base RTK baseline until the steps below have been followed.

The MS860 receiver can operate as a dual antenna system by either one of the two following methods:

- Enable NMEA/ASCII output message *AVR* on any port.
- Enable STREAMED OUTPUT binary message *ATTITUDE INFO* on any port.

To enable NMEA/ASCII output message *AVR*:

1. Click **[CONTROL]**, click **[ALPHA]**, and then click on the **<SERIAL PORT OUTPUT>** softkey.
2. Click the **<NMEA/ASCII OUTPUT>** softkey.
3. Toggle the *TYPE* field to *AVR*.
4. Select any Port and any frequency other than *OFF*.

To enable STREAMED OUTPUT binary message *ATTITUDE INFO*:

1. Click **[CONTROL]**, click **[ALPHA]**, and then click on the **<SERIAL PORT OUTPUT>** softkey
2. Click the **<STREAMED OUTPUT>** softkey.
3. Select any port.
4. Toggle the *TYPE* field to *ATTITUDE INFO*.
5. Select any frequency or offset.

Once either of these message formats has been enabled, you can verify that the receiver is operating correctly by viewing the Attitude screen, see page 2-19.

9.4 MS860 Specifications

The following tables list specifications for the MS 860 receiver.

Table 9-3 Physical Characteristics

Size	29cm X 28cm x 9cm
Weight	4.8 Kg
Operating temperature	-40°C to +70°C
Storage temperature	-55°C to +85°C
Humidity	MIL 810 E, Meth. 507.3 Proc III, Aggravated, 100% condensing
Sealing	Sealed to ± 5PSI
Vibration	MIL 810 D, Tailored Random 8 gRMS Operating
Mechanical Shock	MIL 810 D ± 40g Operating ± 75g Survival

Table 9-4 Electromagnetic Compatibility

Radiated Emissions	CE Class B
Conducted Emissions	SAE J1113/41
Radiated Immunity	CE Class B 60V/m
ESD	± 15 KV
Input Voltage Transients	ISO 7637-2, Pulses 1 - 5

Table 9-5 Technical Specifications

Tracking	18 channels L1 C/A code, L1/L2 full cycle carrier. Fully operational during P-code encryption.
Signal Processing	Supertrak ⁴ Multibit Technology Everest TM Multipath Suppression
Initialization	Automatic OTF (on-the-fly) while moving
Time Required	Typically <1 minute
Range	Up to 10 km for RTK
Start-up	<90 seconds from power on to positioning <30 seconds with recent ephemeris
Communications	3 x RS-232 ports. Baud rates up to 115,200 2 x CAN/J1939
Power	9-32 VDC, 15 watts

Table 9-6 Positioning Specifications

Mode	Accuracy¹	Latency²	Max Rate
Synchronized RTK	1 cm + 2ppm Horizontal 2 cm + 2ppm Vertical	300 ms ³	10 Hz
Low Latency	2 cm + 2ppm Horizontal ⁴ 3 cm + 2ppm Vertical	<20ms	20 Hz
DGPS	< 1m	<20ms	20 Hz
Moving Baseline RTK	1cm Horizontal ⁵ 2 cm Vertical	<100 ms	10 Hz
¹ 1 sigma level ² At maximum output rate ³ Dependent on data link throughput ⁴ Assumes 1 second data link delay ⁵ Assumes that reference-rover separation is less than 1 Km			

9.5 MS860 Cables and Connectors

The figures in this section provide detailed pinout information for both standard and optional cables for the MS860 receiver. This information can be used to prepare special cables for devices and instruments not currently supported by the MS860 cable options.

9.5.1 I/O 1 and I/O 2 Connectors

Figure 9-2 defines the pinout requirements for the connector labeled I/O 1.

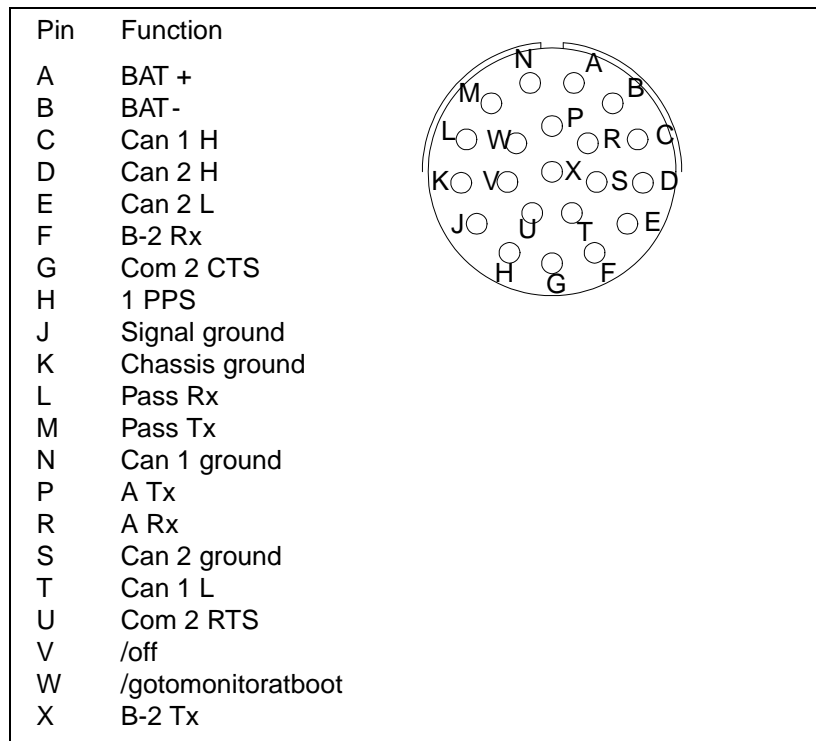

Figure 9-2 MS860 I/O 1 - 21-pin Connector

Figure 9-3 gives the pinout requirements for the connector labeled I/O 2.

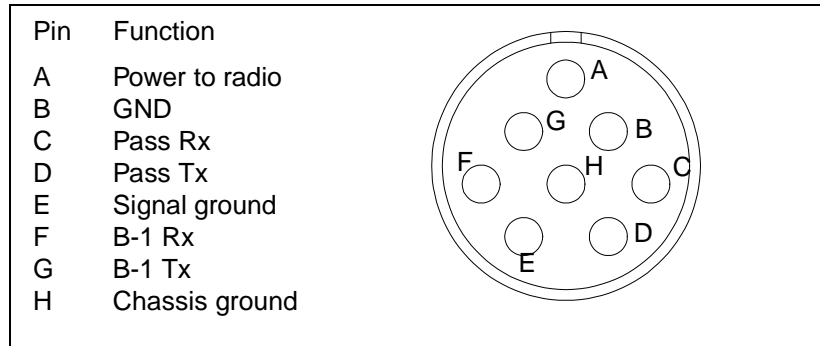

Figure 9-3 MS860 I/O 2 - 8-pin Connector

9.5.2 Data/Power Cable

Table 9-7 defines the pinout requirements for the data/power cable assembly, P/N 39839-06, provided with the MS860 receiver.

Table 9-7 Pinout for Data/Power Cable 39839-06

P1 (21 pin)	P2 (DB-9/f)	P3(DB-9/m)	P4(DB-9/f)	Bare Leads (12 GAUGE)
MS860 I/ O1	PORT A	PORT B-2	TC 900 SCC2	POWER
A	-----	-----	-----	Red V+
B	-----	-----	-----	Black V+
C	-----	-----	6 CAN 1+	-----
D	-----	-----	-----	-----
E	-----	-----	-----	-----
F	-----	2 RX3	-----	-----
G	7 CTS	-----	-----	-----
H	9 PPS	-----	-----	-----
J	5 GND	5 GND	5 GND	-----
K	-----	-----	-----	-----
L	-----	-----	2 PASS RX	-----
M	-----	-----	3 PASS TX	-----
N	-----	-----	7 CAN 1 GND	-----
P	2 TX2	-----	-----	-----
R	3 RX2	-----	-----	-----
S	-----	-----	-----	-----
T	-----	-----	9 CAN1-	-----
U	8 RTS	-----	-----	-----
V	-----	-----	-----	-----
W	6 PWRON	-----	-----	-----
X	-----	3 TX3	-----	-----

9.5.3 Data Cable

Table 9-8 defines the pinout requirements for the data cable assembly, P/N 39397-06, provided with the MS860 receiver.

Table 9-8 Pinout for Data Cable 39397-06

P1 (8-pin MilSpec)		Wire Color	P2 (DB9-F)	
1(A)	V+	Red	6	N/C
2(B)	V-	Black	1	N/C
3(C)	Pass Rx	Orange	7	N/C
4(D)	Pass Tx	Yellow	8	N/C
5(E)	Sig Gnd	Brown	5	Sig Gnd
6(F)	B-1 Rx	Green	3	Rx
7(G)	B-1 Tx	Blue	2	Tx
8(H)	Chassis/Shield	N/C	9	N/C
	Body			Body
NOTE: N/C means not connected. For example, voltage lines are run through cable but not connected at the pins of connector.				

9.5.4 MS860 Receiver Dimensions

Figure 9-4 shows the external dimensions of the MS860 receiver.

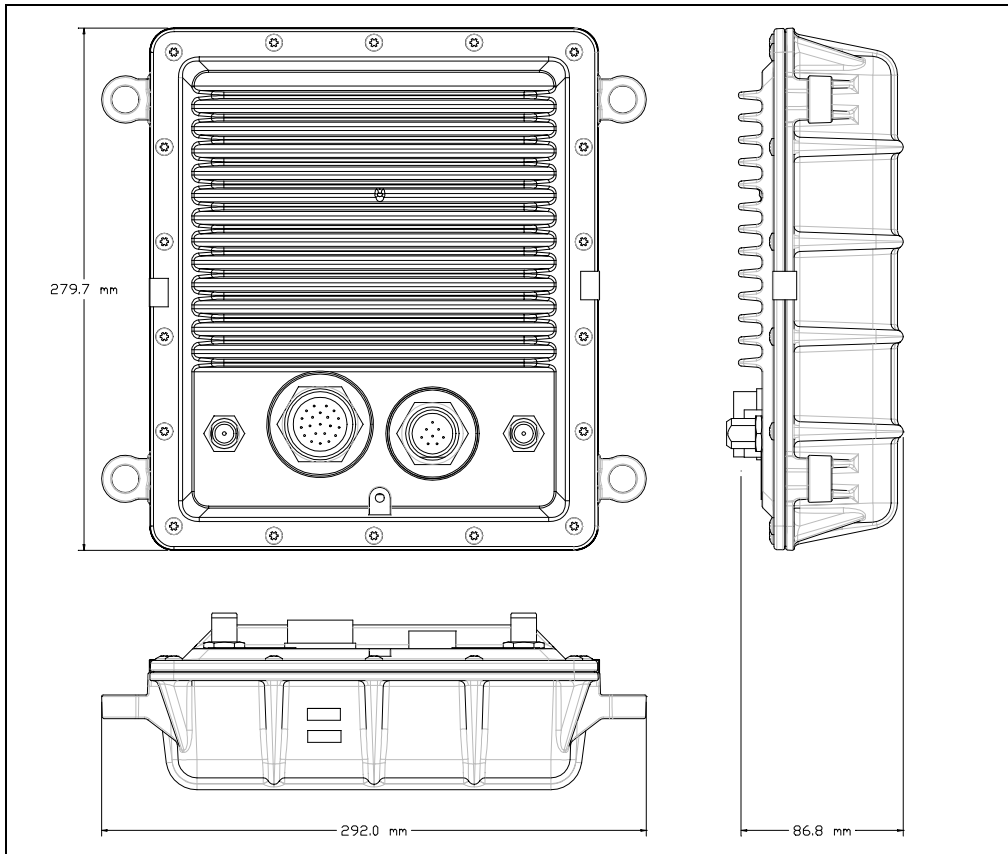

Figure 9-4 MS860 Receiver Dimensions



A Updating Firmware

Trimble distributes firmware upgrades on disk, or, if you have a modem, you can download the upgrade file from the Trimble Web Site (refer to the Preface).

Do the following to update the MS Series receiver firmware:

1. Connect power to the receiver.
2. Connect a serial port of the PC to Port A on the receiver.
3. Power up the MS Series receiver.
4. Run the UPDATE batch file from the DOS prompt.

The program finds the baud rate of the instrument, sets the baud rate to 57,600, extracts the serial number of the receiver, checks to see if that serial number has a current firmware support registration, and then proceeds to perform the update. When completed, the program instructs the receiver to reboot.

5. To verify successful update:
 - Power on the MS Series receiver and display the *Receiver Screens* menu. Press  or  until the *Firmware Version and Release Date* screen is displayed, then verify the new firmware version number.
 - On the MS860 receiver and BD750 receiver the firmware version can be checked under the *Status* screen using the remote controller.



Note – The MS860 receiver must be configured to compute Attitude, (see Configuring the MS860 to Compute Attitude, page 9-14) so both the master and slave processors are upgraded with new firmware. Once the firmware has been upgraded on the MS860 receiver, the unit should remain powered-on for 20 minutes for successful transfer of the code from the master to the slave.

B Serial Number Form

Fill out this form when you unpack the receiver(s). Copy or remove the form and store it in a safe place. You may need the serial numbers if the equipment is lost, stolen, or damaged.

Table B-1 Receiver Information

Description	Serial Number	Part Number

Table B-2 Antenna Information (Optional)

Description	Serial Number	Part Number

Table B-3 Power Source Information (Optional)

Description	Serial Number	Part Number

Table B-4 Battery Information (Optional)

Description	Serial Number	Part Number

C Configuration Toolbox Software

Included with the MS Series receiver is a copy of the Configuration Toolbox software.

Configuration Toolbox software is a Windows application which provides a graphical user interface to configure selected Trimble GPS receivers. It is also possible to create a file, called an application file or *app file*, which contains all the receiver settings necessary for a particular job or application. For applications requiring real-time positions in any coordinate system other than WGS-84, the Configuration Toolbox software is required to define and upload the necessary coordinate system and transformation parameters.

Receiver configuration with the Configuration Toolbox software involves changing the settings that control the operation of the receiver using a predefined file. The configuration settings are stored in this application file (*.cfg).

The Configuration Toolbox software lets you create and edit application files, transfer them to and from the receiver, and manage application files stored in the receiver.

Application files can be stored on both the receiver and computer. Multiple files can be maintained to represent multiple users sharing a device and/or multiple modes of operation. Files can also be saved to audit the operating settings of a receiver. A maximum of ten files can be stored in the MS750 receiver. This includes two files which are always resident in the MS750 receiver, *default.cfg* and *current.cfg*.

C.1 System Requirements

The minimum system requirements to run the Configuration Toolbox software follows:

- 80386 processor
- 4 MB RAM
- VGA monitor
- Serial port for receiver communications
- Mouse or pointing device
- Standard 101-key keyboard
- 3.5-inch 1.44 MB floppy-disk drive
- 5 MB of available hard drive space
- Windows 3.1 or later

The Configuration Toolbox software requires one serial port dedicated for receiver communications. If a serial mouse or other pointing device is used, two serial ports are required.

Using a 80486 or Pentium processor, a higher clock speed, or more RAM enhances software performance.

C.2 Installation Procedure

To install the Configuration Toolbox software on the PC, perform the following steps:

1. Start the installation program for:
 - **Windows 3.1 or Windows NT 3.5.1:**
 - a. Insert the Installation diskette in the PC's CD drive.
 - b. Select *File* and *Run* from Program Manager.
 - c. Type **A:\INSTALL** in the *Command Line:* field and click on OK or press **[Enter]** to run the Configuration Toolbox installation program. Substitute the drive letter, if the installation diskette was not inserted into Drive A.
 - **Windows 95, 98 or Windows NT 4.00:**
 - a. Insert the installation diskette in the PC's CD drive.
 - b. Click **[Start]**, and select *Settings/Control Panel* from the *Start* menu.
 - c. Double click the *Add/Remove Programs* icon.
 - d. Click the *Install* button on the *Add/Remove Properties* dialog, and follow the on-screen instructions.

The install program displays a *Welcome* screen and asks *Do you want to continue?*

2. Press **OK** to continue or **Cancel** to exit. If you decided to continue, accept the default directory **C:\TOOLBOX** or type the directory path of your choice, then press **[Enter]**.

The install program displays the required storage requirements and installation directory.



Note – Installing new versions of the Configuration Toolbox software into a directory containing a previous version overwrites the older program and data files. Application files located in the root installation directory, C:\TOOLBOX by default, are moved to the APPFILE\ subdirectory are described in Step 5.

3. Press **Yes** to install the program files or **No** to exit.
4. The following icons are created as the installation process continues:
 - Configuration Toolbox
 - Configuration Toolbox Help
 - Configuration Toolbox Release Notes
 - Coordinate System Editor
 - Coordinate System Editor Help

For Windows 3.1 or Windows NT 3.51, these icons are added to the Configuration Toolbox program group.

For Windows 95 and Windows NT 4.0 or later, these icons are added to the Configuration Toolbox group under the Program item of the *Start* menu.

5. The installation program creates the following subdirectories within the installation directory:

bin\	Contains Configuration Toolbox executable and dynamic link libraries.
appfiles\	This is the referred directory for storing application files. Existing application files from earlier versions of Configuration Toolbox are moved here during the installation.
cseditor\	Contains the Coordinate System Editor executable, dynamic link libraries, and help files.
geolib\	Contains the geodetic database files used by Configuration Toolbox and the Coordinate System Editor.

C.3 Using Configuration Toolbox Software

To create and transmit an application file to the receiver, you can proceed in several different ways. The general flow includes the following steps:

1. Create and save the application file in the Configuration Toolbox software.
2. Connect the receiver to the computer, apply power, and establish communications between the receiver and computer.
3. Open the desired application file in the Configuration Toolbox software.
4. Transmit the desired application file to the receiver.
5. Check the receiver to ensure the desired application file is currently in use.

C.3.1 Configuring the MS Series Receiver

To configure the MS Series receiver using the Configuration Toolbox software:

1. Start the Configuration Toolbox software by double clicking on `ctoolbox.exe`
2. Select *File / New / MS Series...* .
3. Make appropriate selections for desired receiver settings (see on-line help and the Configuration Toolbox manual for specific questions)
4. Save application file using *File / Save As...* .

Specify the same file name for saving both in the computer and on the receiver. That is, use the same 8-character file name to save on the computer as you specified for naming inside the receiver. This name is assigned in Figure C-1:

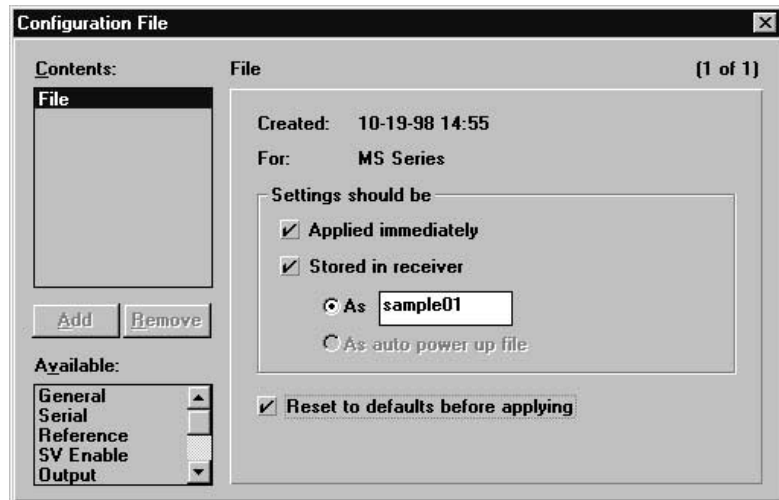

Figure C-1 Configuration File Window

C.3.2 Transmitting the Application File

To transmit the application file to the receiver:

1. Connect the data/power cable (P/N 30945) to the MS Series, the computer, and a 12-V power source.
2. Connect the 12-pin CONXALL connector to Port A or B of the MS Series
3. Connect the female DB9 connector to the computer.
4. Connect the power leads to a 12 VDC power source.
5. Open the desired application file by selecting *File / Open*.
6. With the file open and the Configuration File dialog open, select *Communications / Transmit File*.

A message appears informing you the application file has been successfully transmitted. In the event of an error, select *Communications / Transmit File* again. This overrides any incompatibility in baud rates and enable successful communication.

To check the successful transmission, close the *Configuration File* dialog and select *Communications / Get File*. A list of all application files in the MS Series appears. If you selected **Apply Immediately** in the application file, this new file will be the current file. To change files, select the desired file from the list and then select *Communications / Activate File*.

D Hexadecimal Conversion Table

The table in this appendix is useful for converting decimal numbers and the decimal numbers assigned to ASCII characters to hexadecimal format.

Dec	Hex	ASCII
0	00h	
1	01h	
2	02h	
3	03h	
4	04h	
5	05h	
6	06h	
7	07h	
8	08h	
9	09h	
10	0Ah	
11	0Bh	
12	0Ch	
13	0Dh	
14	0Eh	
15	0Fh	
16	10h	
17	11h	
18	12h	
19	13h	
20	14h	
21	15h	
22	16h	
23	17h	
24	18h	
25	19h	
26	1Ah	
27	1Bh	

Dec	Hex	ASCII
28	1Ch	
29	1Dh	
30	1Eh	
31	1Fh	
32	20h	Space
33	21h	!
34	22h	"
35	23h	#
36	24h	\$
37	25h	%
38	26h	&
39	27h	'
40	28h	(
41	29h)
42	2Ah	*
43	2Bh	+
44	2Ch	,
45	2Dh	-
46	2Eh	.
47	2Fh	/
48	30h	0
49	31h	1
50	32h	2
51	33h	3
52	34h	4
53	35h	5
54	36h	6
55	37h	7

Dec	Hex	ASCII
56	38h	8
57	39h	9
58	3Ah	:
59	3Bh	;
60	3Ch	<
61	3Dh	=
62	3Eh	>
63	3Fh	?
64	40h	@
65	41h	A
66	42h	B
67	43h	C
68	44h	D
69	45h	E
70	46h	F
71	47h	G
72	48h	H
73	49h	I
74	4Ah	J
75	4Bh	K
76	4Ch	L
77	4Dh	M
78	4Eh	N
79	4Fh	O
80	50h	P
81	51h	Q
82	52h	R
83	53h	S

Dec	Hex	ASCII
84	54h	T
85	55h	U
86	56h	V
87	57h	W
88	58h	X
89	59h	Y
90	5Ah	Z
91	5Bh	[
92	5Ch	\
93	5Dh]
94	5Eh	^
95	5Fh	_
96	60h	`
97	61h	a
98	62h	b
99	63h	c
100	64h	d
101	65h	e
102	66h	f
103	67h	g
104	68h	h
105	69h	i
106	6Ah	j
107	6Bh	k
108	6Ch	l
109	6Dh	m
110	6Eh	n
111	6Fh	o

Dec	Hex	ASCII
112	70h	p
113	71h	q
114	72h	r
115	73h	s
116	74h	t
117	75h	u
118	76h	v
119	77h	w
120	78h	x
121	79h	y
122	7Ah	z
123	7Bh	{
124	7Ch	
125	7Dh	}
126	7Eh	~
127	7Fh	
128	80h	
129	81h	
130	82h	
131	83h	
132	84h	
133	85h	
134	86h	
135	87h	
136	88h	
137	89h	
138	8Ah	
139	8Bh	

Dec	Hex	ASCII
140	8Ch	
141	8Dh	
142	8Eh	
143	8Fh	
144	90h	
145	91h	
146	92h	
147	93h	
148	94h	
149	95h	
150	96h	
151	97h	
152	98h	
153	99h	
154	9Ah	
155	9Bh	
156	9Ch	
157	9Dh	
158	9Eh	
159	9Fh	
160	A0h	
161	A1h	
162	A2h	
163	A3h	
164	A4h	
165	A5h	
166	A6h	
167	A7h	

Dec	Hex	ASCII
168	A8h	
169	A9h	
170	AAh	
171	ABh	
172	ACH	
173	ADh	
174	Aeh	
175	Afh	
176	B0h	
177	B1h	
178	B2h	
179	B3h	
180	B4h	
181	B5h	
182	B6h	
183	B7h	
184	B8h	
185	B9h	
186	BAh	
187	BBh	
188	BCh	
189	BDh	
190	BEh	
191	Bfh	
192	C0h	
193	C1h	
194	C2h	
195	C3h	

Dec	Hex	ASCII
196	C4h	
197	C5h	
198	C6h	
199	C7h	
200	C8h	
201	C9h	
202	CAh	
203	CBh	
204	CCh	
205	CDh	
206	CEh	
207	CFh	
208	D0h	
209	D1h	
210	D2h	
211	D3h	
212	D4h	
213	D5h	
214	D6h	
215	D7h	
216	D8h	
217	D9h	
218	DAh	
219	DBh	
220	DCh	
221	DDh	
222	DEh	
223	DFh	

Dec	Hex	ASCII
224	E0h	
225	E1h	
226	E2h	
227	E3h	
228	E4h	
229	E5h	
230	E6h	
231	E7h	
232	E8h	
233	E9h	
234	EAh	
235	EBh	
236	ECh	
237	EDh	
238	EEh	
239	EFh	
240	F0h	
241	F1h	
242	F2h	
243	F3h	
244	F4h	
245	F5h	
246	F6h	
247	F7h	
248	F8h	
249	F9h	
250	FAh	
251	FBh	

Dec	Hex	ASCII
252	FCh	
253	FDh	
254	FEh	
255	FFh	

Bibliography

SS-GPS-300B

System Specification for the NAVSTAR Global Positioning System

ICD-GPS-200

see: NAVSTAR GPS Space Segment/Navigation User Interfaces

Differential GPS Explained, Trimble P/N 23036 (1993)

A companion to *GPS, A Guide to the Next Utility*, explaining the topic of differential GPS (DGPS).

GPS, A Guide to the Next Utility, Trimble P/N 18239 (1992)

A short, non-technical introduction to GPS/ Explains what GPS does, how it works, and what its capabilities and limitations are.

Guide to GPS Positioning, David Wells (editor), Canadian GPS Associates (1986).

A comprehensive introduction to the principles and applications of GPS. While this book's perspective and terminology are outdated, it remains a standard work in the field. The papers cover a spectrum from highly conceptual to highly technical.

Proceedings of the Institute of Navigation, Washington DC

A series of 3 abstracts published between 1980 & 1986 of papers from the Journal of the Institute of Navigation. Essential source material for any system designer.

RTCM Recommended Standards for Differential GPS Service. RTCM Paper 194-93 / SC104-STD (January 3, 1994), Trimble P/N 19454.

Defines Version 2.1 of the RTCM message protocol.

NAVSTAR GPS Space Segment: Navigation User Interfaces, drawing number ICD-GPS-200 (3 July 1991).

The official definition of the data formats used in NAVSTAR GPS satellite signals. The document is published in two versions: a public release version that excludes classified information about P-code, and a controlled release version that includes the classified information. The public release version is distributed by the United States Coast Guard. Write or call:

Commanding Officer
USCG ONSCEN
7323 Telegraph Road
Alexandria, VA 22310
(703) 313-5900

RTCM, 1998. RTCM Recommended Standards for Differential GNSS Service, Version 2.2, RTCM Paper 11-98/SC104-STD, January 15.

Defines Version 2.2 of the RTCM recommendations for differential GNSS service.

Talbot, N.C. 1996. Compact Data Transmission Standard for High-Precision GPS, ION-GPS-96, Kansas City, Missouri, September 17-20, pp.861-871.

Referred to as Talbot A in the manual text.

Talbot, N.C. 1997. Improvements in the Compact measurement Record Format, Trimble Users Conference, San Jose, California. pp.322-337.

Referred to in the manual text.

TRIMTALK 900 Operation Manual, Trimble P/N 27608-00

User manual for the TRIMTALK 900, a short-range radio intended for linking receivers for RTK surveying or DGPS applications.

Using Radio Communication Systems with GPS Surveying Receivers, a Trimble Navigation Application & Technical Note (no part number).

This brief document suggests some measures you can take to deal with interference when using GPS receivers with radio links.

Glossary

This section defines technical terms and abbreviations used in Trimble documentation. These definitions are oriented to the needs of MS750 receiver users. Many have been simplified to exclude details that are not relevant to the MS750 receiver, or to reduce the amount of technical background required to understand them.

absolute positioning	The process of computing a position fix from satellite data alone, without reference to corrections supplied by a reference station. Also known as autonomous positioning.
acquisition	The process of locking onto a satellite's C/A code and P-code. A receiver acquires all available satellites when it is powered up, and acquires additional satellites as they become available. Once a receiver acquires a satellite, it tracks that satellite until the satellite's signal becomes unavailable.
almanac	Information about NAVSTAR satellite orbits, Keplerian elements, clock corrections, atmospheric delay parameters, and health status transmitted by each satellite. GPS receivers use this information for satellite acquisition and postprocessing.
AH	Ampere hour(s), a measure of a battery's capacity to deliver current over time. A 10 AH battery can deliver 1 ampere for 10 hours, 2 amperes for 5 hours, and so on.
Anti-Spoofing (AS)	A feature that allows the U.S. Department of Defense to transmit an encrypted Y-code in place of P-code. Y-code is intended to be useful only to authorized (primarily military) users. Anti-Spoofing is used with Selective Availability to deny the full precision of the NAVSTAR GPS system to civilian users.

application	A class of tasks that a GPS receiver can be used to accomplish. Control surveying, topographic surveying, and navigation are examples of applications.
autonomous positioning	A mode of operation in which a GPS receiver computes position fixes in real time from satellite data alone, without reference to data supplied by a base station. Autonomous positioning is the least precise positioning procedure a GPS receiver can perform, yielding position fixes that are precise to ± 100 meters horizontal RMS when Selective Availability is in effect, and to ± 10 – 20 meters when it is not. Also known as <i>absolute positioning</i> .
base station	(1) A receiver that observes satellite data from a known, fixed location during a survey or other GPS procedure, together with its antenna, tripod, etc. (2) The site at which such a receiver operates. Also known as a <i>reference station</i> .
baseline	The three-dimensional vector distance between a pair of stations, computed from simultaneously collected GPS data by means of carrier-phase processing. This technique is used in surveying applications. It yields the most accurate GPS results.
broadcast ephemeris	A set of data that describes the predicted positions of a GPS satellite through the near future. Each GPS satellite periodically transmits its own broadcast ephemeris, which is uploaded to the satellite by the Control Segment. See also <i>ephemeris</i> .
carrier beat phase	The difference between the carrier signal generated by a receiver's internal oscillator and the carrier signal received from a satellite.
code phase difference	The phase difference between received C/A or P-code and the same code generated internally by the receiver. Used to determine the range to a satellite.

Coarse/ Acquisition code (C/A code)	A pseudorandom noise code (PRN) modulated onto a GPS satellite's L1 signal. This code helps the receiver compute its distance from the satellite.
continuous kinematic surveying	A type of kinematic surveying in which the roving receiver makes carrier phase observations while in motion. Continuous kinematic surveying is useful for aerial surveying, topographic surveying, and vehicle tracking.
control mark	A mark on the earth whose coordinates are known and accepted, or are being surveyed, for use as a reference in other surveys. Also known as a control point or control station.
Control Segment	That part of a GPS system that monitors the satellites (the Space Segment) and feeds information to them. The NAVSTAR system's Control Segment consists of monitor stations, upload stations, and a master control station. See also <i>Space Segment</i> , <i>User Segment</i> .
control surveying	A type of surveying in which the relationships among selected points in a region of interest are measured with high, repeatable precision. These points are often used as reference marks in other surveys of the same area. Because control surveying requires more precision than other types of surveying and covers fewer points, it generally uses procedures that are slower but more accurate. See also <i>topographic surveying</i> .
cycle	(1) One complete wave of a radio signal; 360° of phase shift. (2) Occasionally, a synonym for <i>epoch</i> , the length of each period in which a GPS receiver makes one set of satellite measurements.
cycle slip	An interruption in a receiver's lock on a satellite's radio signals. Some surveying procedures require an observation to be restarted if a cycle slip temporarily reduces the number of satellites tracked to less than the minimum required.

datum	A model of the earth consisting of a specifically-oriented reference ellipsoid and an origin. Positions are described by a latitude and longitude, and they may be described in plane coordinates, if a projection has been specified. The ellipsoid and origin are chosen to yield that most accurate and convenient approximation of the surface of the earth for mapping in a particular region. See also <i>local datum</i> , <i>WGS-84</i> .
DOP	Dilution of precision, a class of measures of the magnitude of error in GPS position fixes due to the orientation of the GPS satellites with respect to the GPS receiver. There are several DOPs to measure different components of the error. See also <i>GDOP</i> , <i>HDOP</i> , <i>PDOP</i> , <i>TDOP</i> , <i>VDOP</i> .
DOY	Day of the year, a number from 1 to 365 (366 in leap years). Also known as a <i>Julian day</i> .
dual-frequency	Using both the L1 and L2 signals from GPS satellites. Used to describe MS750 receiver, antennas, procedures, and so on. For data postprocessing, a dual-frequency receiver can compute more precise position fixes over longer distances and under more adverse conditions by measuring and compensating for ionospheric delay errors. For real-time data processing, the advantage is quicker initialization. See also <i>single-frequency</i> .
earth-centered earth-fixed (ECEF)	A Cartesian coordinate system used for satellite positioning. The ECEF coordinate system's origin is at the earth's center of mass. The z axis is coincident with the mean rotational axis of the earth, with positive values to the north. The x axis passes through 0° N, 0° E, with positive values in that direction. The y axis is perpendicular to the plane of the x and z axes, with positive values to the direction of 0° N, 90° E. The WGS-84 datum is defined with reference to the ECEF coordinate system.
ELEV	Elevation; the angle from the horizon to the observed position of a satellite.

elevation mask	A parameter that specifies a minimum elevation at which the receiver will track a satellite.
ellipsoid	A mathematical figure generated by rotating an ellipse on its minor axis. Geodetic surveying operations use an ellipsoid as a model of the surface of the earth; the minor axis represents the earth's axis of rotation. See also <i>Reference ellipsoid</i> .
ephemeris	A set of data that describes the position of a celestial object as a function of time. The plural is ephemerides. Each GPS satellite periodically transmits a <i>broadcast ephemeris</i> describing its predicted positions through the near future, uploaded by the Control Segment. Postprocessing programs can also use a <i>precise ephemeris</i> which describes the exact positions of a satellite at relevant times in the past.
epoch	The measurement interval used by a GPS receiver; also called a <i>cycle</i> . Satellite measurements, position fix computations, and most cycle printouts are produced once per epoch.
flow control	A means of coordinating two communicating devices so that one transmits data only when the other is prepared to receive it. The MS750 receiver also supports CTS/RTS flow control on serial port A.
GDOP	Geometric dilution of precision, an overall measure of the magnitude of DOP errors in GPS position fixes. PDOP and TDOP are components of GDOP. See also <i>DOP</i> .
geodetic position	The coordinates of a mark, measured with reference to a defined ellipsoid.
geoid	The gravity-equipotential surface that best approximates mean sea level over the entire surface of the earth.

GIS data acquisition	An application in which a receiver collects position data for a geographic information system (GIS) database. GIS data acquisition is similar to logging position fixes, except that the data logger also collects attribute information about points of interest (such as identification numbers or street names) as well as coordinates.
GMT	Greenwich Mean Time.
GPS	Global Positioning System; the navigation/positioning system consisting of NAVSTAR satellites, their ground stations, and GPS receivers such as the MS750 receiver.
GPS time	A measure of time used internally by the NAVSTAR GPS system. GPS time is based on UTC, but does not add periodic leap seconds to correct for changes in the Earth's period of rotation.
GRS-80	Geodetic Reference System of 1980; an oblate ellipsoid, or ellipsoid of revolution, on which the North American Datum of 1983 (NAD83) is based. This datum has very nearly the same semi-major and semi-minor axis as WGS-84 (the reference ellipsoid for GPS) and differs slightly only in the flattening ($1/f$).
HDOP	Horizontal dilution of precision; a measure of the magnitude of DOP errors in latitude and longitude. See also <i>DOP</i> .
HI	In surveying, the height of the instrument above a reference mark. In GPS surveying, this is more commonly referred to as Antenna Height or AH.
HVEL	Horizontal velocity.
Issue of data ephemeris (IODE)	A value identifying a version of an ephemeris.

Julian date	A date expressed as a year and the number of the day within the year. For example, January 1, 1994 expressed as a Julian date is 94001; February 1, 1994 is 94032. The day is known as a Julian day, or day of year (DOY).
L1	The primary L-band carrier used by GPS satellites to transmit satellite data. Its frequency is 1575.42 MHz. It is modulated by C/A code, P-code, and a 50 bit/second Navigation Message.
L2	The secondary L-band carrier used by GPS satellites to transmit satellite data. Its frequency is 1227.6 MHz. It is modulated by P-code and a 5 0bit/second Navigation Message.
latitude (LAT)	The north/south component of the coordinate of a point on the surface of the earth; expressed as an angular measurement from the plane of the equator to a line from the center of the earth to the point of interest.
latitude/ longitude/ height (LLH)	A method of describing a position by its latitude and longitude on a datum. See also <i>northing/easting/height</i> .
LED	Light-emitting diode.
local datum	A datum that is designed for accuracy and convenience in surveying in a particular locality. In the <i>MS750 Operation Manual</i> , any datum other than the WGS-84 datum is considered a local datum.
local zone	A projection of a local datum onto a plane, with positions expressed as northings and eastings from a specified origin on the plane; also, the region in which such a projection is considered meaningful. See also <i>projection coordinates</i> .
lock	The state in which a GPS receiver receives and recognizes a satellite's signals. If the signals are interrupted, the receiver experiences loss of lock, a common cause of interruption in a kinematic or RTK survey.

longitude (LON)	The east/west component of the coordinate of a point on the surface of the earth; expressed as an angular measurement from the plane that passes through the earth's axis of rotation and the 0° meridian and the plan that passes through the axis of rotation and the point of interest.
mean sea level (MSL)	A vertical reference based on sea level averaged over a specific period of time.
multipath interference	Interference created when a receiver simultaneously detects signals received directly from a transmitter and signals reflected off other objects, such as the ground. Multipath interference is the usual cause of ghosts in a television picture. See also <i>multipath error</i> .
multipath error	An error in the position fixes computed by a GPS receiver, caused by multipath interference with satellite signals.
NAD-83	North American Datum, 1983. A horizontal datum forming the basis for primary horizontal control networks in the United States. This datum is based on the GRS-80 Ellipsoid.
navigation	An application in which a receiver provides information about a vehicle's location and course, helping the operator to guide the vehicle to its destination. Navigation may be done on water or land, or in the air.
NAVSTAR	The name of the satellites used in the Global Positioning System (GPS). It is an acronym for N avigation S ystem with T ime and R anging.
NGS	The United States National Geodetic Survey, the geodetic surveying agency of the United States government.

NMEA-0183	A standard established by the National Marine Electronics Association (NMEA) that defines electrical signals, data transmission protocol, timing, and sentence formats for communicating navigation data among marine navigation instruments.
northing/ eastings/height (NEH)	A method of describing a position by its distance north and east of the origin in a local zone. The height is the same as on the datum associated with the zone.
observation	A set of measurements made at a mark (or, in dynamic procedures, while moving between marks). GPS receivers perform observations by tracking and analyzing satellite signals.
OSM2	Office Support Module 2, a power supply, battery charger, and interface device used with Trimble's portable receivers.
P-code	Precise code or protected code; a pseudorandom code transmitted by a NAVSTAR satellite. Each satellite has a unique code that it modulates onto the L1 and L2 signals. P-code is replaced by an encrypted Y-code when Anti-Spoofing is active; Y-code is intended to be available only to authorized (primarily military) users. See also <i>Coarse/Acquisition code</i> , <i>Anti-Spoofing</i> , and <i>Y-code</i> .
PDOP	Position dilution of precision, a measure of the magnitude of DOP errors in the x , y , and z coordinates. See also <i>DOP</i> .
PDOP mask	A receiver parameter specifying a maximum PDOP value for positioning. When the geometric orientation of the satellites yields a PDOP greater than the mask value, the receiver will stop computing position fixes and/or logging satellite measurements.
point ID	An eight-character code used to identify a mark in a kinematic survey; equivalent to a mark ID in a FastStatic survey.

precise positioning service (PPS)

The most precise level of dynamic position service provided by GPS, based on the use of dual-frequency P-code. This service is subject to encryption, and when encrypted it is available only to United States military agencies and other authorized users. See also *standard positioning service*.

precision positioning

A type of GPS application in which the receiver's position must be determined precisely, epoch by epoch. Precision positioning may be used to track the position of a vehicle (such as an aerial camera) or to control servomechanisms that maintain the position of a mobile object (such as a marine oil exploration platform).

PRN

Pseudorandom noise, a sequence of binary digits that appears to be randomly distributed but can be exactly reproduced. Identical PRN sequences have a low auto-correlation value except when they are exactly coincident. Each GPS satellite transmits a unique PRN in both C/A and P-code. GPS receivers use PRNs to identify and lock onto satellites and to compute their pseudoranges.

projection (coordinates)

A mapping of a set of coordinates from a curved surface to a plane; or a set of mathematical rules for performing such a translation. Projections are used to create flat maps that represent the surface of the earth or parts of it. A MS750 receiver uses the definition of a projection and datum to transform position fixes from the WGS-84 datum to the local coordinate system.

pseudorange

The apparent distance from a satellite to the phase center of a GPS receiver's antenna, computed as the product of apparent signal propagation time and the speed of light. Differences between pseudorange and real range are caused by offsets between the satellite and receiver clocks, by propagation delays, and by other errors.

Real-Time Kinematic (RTK)	A surveying or positioning procedure that yields very accurate position fixes in real time. It uses the radio link to transmit carrier phase observables and other information from the base station to the rovers, where all observables are differenced to produce a very precise rover position. It is sensitive to high PDOP and loss of satellite lock.
receiver	As used in this manual, receiver refers to a MS750 receiver. References to other types of receivers are qualified when confusion is possible, for example, communications receiver.
reference ellipsoid	In geodesy, any ellipsoid whose minor axis is defined as the Earth's axis, and whose major axis is defined as being in the equatorial plane. Many global coordinate systems are based on a reference ellipsoid as a model of the Earth's surface. See also <i>WGS-84</i> .
reference mark or point	A mark whose coordinates are known with sufficient accuracy for a given purpose. Also, the physical sign (stake, chalk mark, etc.) used to indicate the position of a mark. Many GPS procedures require one or more receivers to occupy reference marks. Also known in some procedures as a <i>reference point</i> or <i>reference station</i> .
reference position	The accepted coordinates of a mark over which a receiver's GPS antenna is set up. The reference position may be entered manually or may be derived from a receiver's computed position.
reference station	See <i>base station</i> .
RF	Radio frequency.
rover	A receiver that collects data which will be corrected either in real time or postprocessed. A single reference or base station can support unlimited rovers. The term <i>rover</i> usually refers to the receiver's antenna, rangepole or other support, cables, etc, as well as the receiver itself.

RTK/OTF	Real-Time Kinematic/On-The-Fly
satellite data	The data transmitted by a GPS satellite. Also used to denote the data that a receiver logs in a file; this includes data that is processed or originated in the receiver as well as data received from satellites.
satellite geometry	The relative positions of available GPS satellites at a given time, from the viewpoint of a GPS receiver. The satellite constellation that result in a high (or low) PDOP are often described as poor (or good) satellite geometry.
schedule plot	A one-shot printout that plots satellite visibility against time for all known satellites over any UTC day.
Selective Availability (SA)	A U.S. Department of Defense program to limit the accuracy of autonomous position fixes computed by unprivileged (civilian) receivers. Selective Availability works by introducing controlled errors to the GPS satellites' C/A codes. When Selective Availability is in effect, the horizontal coordinates of autonomous position fixes exhibit errors of up to 100 meters 2DRMS. See also <i>Anti-Spoofing</i> .
single-frequency	Using only the L1 carrier phase signal from GPS satellites. Used to describe receivers, antennas, procedures, and so on. See also <i>dual-frequency</i> .
Signal to Noise Ratio (SNR)	A measure of a satellite's signal strength, expressed in arbitrary units.
Space Segment	The part of the NAVSTAR GPS system that operates in space, the satellites. See also <i>Control Segment</i> , <i>User Segment</i> .
standard positioning service (SPS)	The level of positioning precision provided by GPS to civilian users, based on the use of single-frequency C/A code. The precision of standard positioning service is limited by Selective Availability. See also <i>precise positioning service</i> .

station	(1) A receiver being used to perform a GPS procedure, together with its antenna, tripod or range pole, and so on. Usually used in phrases like <i>base station</i> . (2) The site where a receiver is set up. (3) Any of 30 locations whose coordinates can be stored in a receiver's memory and used to specify the location of a receiver in the static and RTK surveying procedures. (4) A synonym for <i>mark</i> in certain procedures.
SV	Space vehicle; specifically, a GPS satellite.
sync time	A receiver parameter that determines the length of a cycle.
TDOP	Time dilution of precision, a measure of the magnitude of DOP errors in position fixes due to user clock offset from GPS time. See also <i>DOP</i> .
timebase	A receiver's source of internal time measurement. All MS750 receivers have an internal quartz oscillator timebase. A receiver with the External Frequency Input Option can also accept signals from a high-precision external timebase such as an atomic clock.
topographic surveying	An application that determines the relative coordinates of points in a region of interest for mapping and three-dimensional modeling applications. See also <i>control surveying</i> .
TOW	Time of week; time measured in seconds from midnight Sunday UTC.
tribrach	A centering and leveling device often used for mounting a GPS antenna or other surveying instrument on a tripod.
tracking	Receiving and recognizing signals from a satellite. For example, a receiver might be described as tracking six satellites. A receiver does not necessarily use the signals from all of the satellites it is tracking; for example, signals from a satellite below the elevation mask may be tracked but will not be used.

User Range Accuracy (URA)	A measure of the errors that may be introduced by satellite problems and Selective Availability if a particular SV is used. A URA of 32 meters indicates that Selective Availability is enabled. The URA value is set by the Control Segment and is broadcast by the satellites.
User Segment	A collective name for the GPS receivers that make use of GPS satellite signals. The world's entire population of GPS receivers constitute the User Segment. See also <i>Control Segment</i> , <i>Space Segment</i> .
Universal Time Coordinated (UTC)	A time standard maintained by the United States Naval observatory, based on local solar mean time at the Greenwich meridian. Equivalent to Greenwich Mean Time (GMT). See also <i>GPS time</i> .
VDOP	Vertical dilution of precision, a measure of the magnitude of DOP errors in the height component of a position fix. See also <i>DOP</i> .
VVEL	Vertical velocity.
WGS-84	World Geodetic System 1984, the current standard datum for global positioning and surveying. The WGS-84 datum is based on the WGS-84 ellipsoid. For Series 4000 receivers, any datum other than WGS-84 is known as a local datum.
Y-code	An encrypted form of the information contained in P-code, which satellites transmit in place of P-code at times when Anti-Spoofing is in effect.

Index

Symbols

APP FILES 6-61
CHANNELS 6-4
CHANNELS L1 6-4
L2 CHANNELS OPERATIONAL 6-6
MEAS TO GO 6-6
OF SVS IN RECORD 6-46, 6-50
SVS LOCKED 6-6
\$
 NMEA start of message delimiter 3-1
% BATTERY REMAINING 6-6
% MEMORY USED 6-30
*
 NMEA checksum delimiter 3-3
*.cfg
 application file extension C-1
,
 NMEA field delimiter 3-1

Numerics

02h (STX) 4-4
03h (ETX) 4-4
06h (ACK) 4-2
06h command packet
 GETSERIAL 5-3
07h report packet
 RSERIAL 6-3
08h command packet

 GETSTAT1 5-4
09h report packet
 RECSTAT1 6-5
1 PPS Cable 7-12
1 PPS CONTROL 5-21
1 PPS OUTPUT
 ASCII TIME TAG 2-46
 ENABLE 2-46
1 PPS output 7-12
15h (ENQ) 4-2
15h (NAK) 4-2, 4-5
1-second epoch 1-5
2-byte INTEGER 4-7
40h report packet
 GENOUT 6-8
4Ah command packet
 GETOPT 5-5
4Bh report packet
 RETOPT 6-9
4-byte header
 Data Collector Format 4-4
4-byte LONG 4-7
54h command packet
 GETSVDATA 5-6
55h report packet
 RETSVDATA 6-33
56h command packet
 GETRAW 5-8
57h 6-44
57h report packet
 RAWDATA 6-43

Index

- 64h command packet
 - APPFILE 5-10
 - 64h report packet
 - APPFILE 6-59
 - 65h command packet
 - GETAPPFILE 5-36
 - 66h command packet
 - GETAFDIR 5-38
 - 67h report packet
 - RETAFDIR 6-60
 - 6Dh command packet
 - ACTAPPFILE 5-40
 - 6Eh report packet
 - BREAKRET 6-64
 - 81h command packet
 - KEYSIM 5-41
 - 82h command packet
 - SCRDUMP 5-43
 - 8-bit word format
 - RS-232 Serial Interface Specification 4-2
 - 8-byte DOUBLE 4-7
- A**
- accuracy
 - centimeter-level 1-2
 - critical factors affecting RTK 1-20
 - meter-level 1-5
 - reference station coordinate 1-21
 - submeter-level 1-2
 - ACK (06h) 4-2, 4-3
 - ACTAPPFILE command packet (6Dh) 5-40
 - Activate Application File
 - Command Packet 6Dh (ACTAPPFILE) 5-40
 - Actual Track Made Good Over and Speed Over Ground
 - VTG message 3-18
 - AF0 6-37
 - AF1 6-37
 - AF2 6-37
 - agriculture equipment positioning 1-1, 7-1
 - ALM DECODE TIME 6-40
 - ALM HEALTH 6-40
 - ALMANAC FLAGS 6-34
 - ALMANAC Report 6-39
 - ALPHA 0 6-42
 - ALPHA 1 6-42
 - ALPHA 2 6-42
 - ALPHA 3 6-42
 - ALTITUDE RATE 6-57
 - Angle of satellite above horizon 6-19
 - antenna
 - cable
 - routing and connecting 7-7, 8-8, 9-9
 - connection scheme 7-9
 - mounting 7-6, 8-6, 9-8
 - electrical interference 7-6, 8-6
 - viewing
 - Antenna Type screen 7-43
 - ANTENNA HEIGHT 5-20
 - Antenna record
 - application file 4-14, 4-16
 - data structure 5-20
 - ANTENNA SERIAL # 6-4
 - ANTENNA TYPE 5-20, 6-4
 - Antenna Type 7-43
 - Anti-spoof flag 6-38
 - APP FILE NAME 6-62
 - APP FILE SIZE 6-62
 - APPFILE 7-18
 - APPFILE command packet (64h) 5-10
 - APPFILE report packet (64h) 6-59
 - application file C-1
 - records
 - general controls 4-14
 - serial port baud/format 4-14

-
- Application File Directory Listing Request
 - Command Packet 66h (GETAFDIR) 5-38
 - Application File Directory Record 6-62
 - application file interface 1-1
 - APPLICATION FILE NAME 5-14
 - Application File Record Command
 - Command Packet 64h (APPPFILE) 5-10
 - Report Packet 64h (APPPFILE) 6-59
 - Application File Request
 - Command Packet 65h (GETAPPPFILE) 5-36
 - APPLICATION FILE SESSIONS
 - Application File Name / Index 2-37
 - Creation Date / Time 2-37
 - File Size 2-37
 - APPLICATION FILE SPECIFICATION
 - VERSION 5-13
 - application files
 - current.cfg C-1
 - Data Collector Format 4-13
 - overview 4-13
 - default directory C-5
 - default.cfg C-1
 - defining
 - Command Packet 6Dh 4-17
 - downloading 4-1, 4-14
 - interface
 - Data Collector Format 4-13
 - mangement 4-5
 - maximun number C-1
 - OUTPUT MESSAGES record 4-13
 - overview C-1
 - record format 4-15
 - record types
 - overview 4-14
 - records
 - Antenna 4-14
 - Coordinate System 4-14
 - Data Collector Format 4-14
 - Device Control 4-14
 - device control 4-14
 - File Storage 4-14
 - file storage 4-14
 - General Controls 4-14
 - Input Message 4-14
 - Output Message 4-14
 - Reference Node 4-14
 - reference node 4-14
 - Serial Port Baud/Format 4-14
 - Static/Kinematic 4-14
 - static/kinematic 4-14
 - SV Enable/Disable 4-14
 - SV enable/disable 4-14
 - requesting list
 - Command Packet 67h 4-17
 - retrieving
 - Report Packet 64h 4-16
 - transmitting C-8
 - uploading 4-1, 4-14
 - viewing
 - default application file 7-18
 - ASCII DATA 6-70
 - ASUB 6-42
 - ASUB1 6-42
 - atmospheric errors 1-5
 - audience xxi
 - AWN 6-40
 - AZIMUTH 6-19, 6-46, 6-49, 6-50
 - Azimuth of satellite from true North 6-19
- B**
- base station configuration 7-52
 - baseline length errors 1-5
 - baseline vector 1-16

Index

- BAUD RATE 5-16
- baud rates
 - RS-232 Serial Interface Specification 4-2
- BETA 0 6-42
- BETA 1 6-42
- BETA 2 6-42
- BETA 3 6-42
- bibliography 1
- binary values
 - DOUBLE 4-7
 - INTEGER 4-7
 - LONG 4-7
 - reading
 - Data Collector Format 4-7
- BOOT ROM VERSION 6-4
- break sequence
 - definition 6-64
 - Report Packet 6Eh 6-64
- Break Sequence Return
 - Report Packet 6Eh (BREAKRET) 6-64
- BREAKRET report packet (6Eh) 6-64

- C**
- C/A (Coarse/Acquisition) 1-1
- cable
 - dual data interface 7-73
- CAN interface 1-2
- carrier phase initialization 1-5
- carrier phase measurements 1-4
- cautions xxv
- centimeter accuracy 1-2
- centimeter-level guidance 1-1, 7-1
- CHAR
 - Data Collector Format 4-7
- CHECKSUM 6-20
 - Data Collector Format 4-4
- CIC 6-37
- CIS 6-37
- Clarion JX-10 Radio 5-22
- CLEAR key 2-10
- CLOCK FLAGS 6-15
- CLOCK INFO (Type 10 Record) 6-15
- CLOCK OFFSET 6-15, 6-46, 6-50
- Clock status flags 6-15
- CMR 7-60
 - CMR (Compact Measurement Format) 1-9
 - CMR 5Hz 7-60
 - CMR data 1-17
 - CMR Input 6-32
 - CMR MESSAGE TYPE FLAGS 5-20
 - CMR Output 6-32
 - CMR Plus 7-60
 - CMR Types 7-60
 - Coarse/Acquisition (C/A) 1-1
 - COCOM ALT/SPEED 6-30
 - COCOM Alt/Speed Option 6-30
 - COCOM limits 1-3
 - COMM 6-65
- command packets
 - 06h, GETSERIAL 5-3
 - 4Ah, GETOPT 5-5
 - 54h, GETSVDATA 5-6
 - 56h, GETRAW 5-8
 - 64h, APPFILE 5-10
 - 65h, GETAPPFILE 5-36
 - 66h, GETAFDIR 5-38
 - 68h, DELAPPFILE 5-39
 - 6Dh, ACTAPPFILE 5-40
 - 81h, KEYSIM 5-41
 - 82h, SCRUMP 5-43
 - 8h, GETSTAT1 5-4
 - overview 5-1
- communication errors
 - RS-232 Serial Interface Specification 4-2
- communications format

- RS232 Serial Interface
 - Specification 4-2
 - Compact Measurement Record (CMR) 1-9
 - Concise Record Format 6-49
 - configuration
 - receiver 2-10, 3-1, 4-1, 5-1, 6-1
 - Configuration File dialog
 - Configuration Toolbox C-7
 - Configuration Toolbox
 - application files 4-13
 - Configuration File dialog C-7
 - configuring C-6
 - Coordinate System Editor C-5
 - directories C-5
 - geodetic database C-5
 - help file C-4
 - installation C-3
 - opening shipping cartons 7-2, 9-4
 - overview C-1
 - release notes C-4
 - software C-1
 - system requirements C-2
 - using C-6
 - Configure Base Type 7-58
 - configuring the MS750 receiver 7-36
 - using keypad 7-39
 - configuring the Series 7400 receiver as a rover 8-11
 - connecting external devices 7-9
 - connections
 - 1 PPS time strobe and time tag 7-75
 - GPS antennas and cables 7-74
 - Contrast 7-19
 - control functions
 - acknowledgments 4-5
 - command packets 4-5
 - Coordinate System Editor
 - Configuration Toolbox C-5
 - Coordinate System record
 - application file 4-14
 - copyrights ii
 - COVAR. EAST-NORTH 6-17
 - COVARIANCE NORTH 6-17
 - CRC 6-37
 - CREATION DAY 6-62
 - CREATION HOUR 6-62
 - CREATION MINUTES 6-62
 - CREATION MONTH 6-62
 - CREATION YEAR 6-62
 - CRS 6-37
 - CTOOLBOX.EXE C-1
 - CUC 6-37
 - CURRENT application file 4-13
 - Current clock offset 6-15
 - CURRENT PORT ID 6-29
 - CURSOR POSITION 6-70
 - CUS 6-37
- ## D
- DATA BYTES
 - Data Collector Format 4-4
 - Data Collector Format
 - 4-byte header 4-4
 - binary values
 - DOUBLE 4-7
 - INTEGER 4-7
 - LONG 4-7
 - command packets
 - 06h, GETSERIAL 5-3
 - 4Ah (GETOPT) 4-5
 - 4Ah, GETOPT 5-5
 - 54h, GETSVDATA 5-6
 - 56h, GETRAW 5-8
 - 64h, APPFILE 5-10
 - 65h, GETAPPPFILE 5-36
 - 66h, GETAFDIR 5-38
 - 68h, DELAPPPFILE 5-39

- 6Dh, ACTAPPPFILE 5-40
- 81h, KEYSIM 5-41
- 82h, SCRDUMP 5-43
- 8h, GETSTAT1 5-4
 - overview 5-1
- FLOAT 4-9
- FLOATING-POINT
 - DOUBLE 4-8
 - exponent field 4-8
 - fraction field 4-8
 - NaN (Not a Number) 4-8
 - overview 4-8
 - sign bit field 4-8
 - SINGLE 4-8
- INTEGER data types
 - CHAR 4-7
 - LONG 4-7
 - SHORT 4-7
- packet functions 4-5
- packet structure 4-4
- packet summary 4-11
- packets 4-1
- report packets
 - 07h, RSERIAL 6-3
 - 09h, RECSTAT1 6-5
 - 40h, GENOUT 6-8
 - 4Bh (RETOPT) 4-5
 - 4Bh, RETOPT 6-28
 - 55h, RETSVDATA 6-33
 - 57h, RAWDATA 6-43
 - 64h, APPFILE 6-59
 - 67h, RETAFDIR 6-60
 - 6Eh, Break Sequence
 - Return 6-64
 - 82h, SCRDUMP 6-70
- RS-232 Serial Interface
 - Specification 4-1
- Data Extension Cable 1-27, 7-3
 - connecting 7-11
 - connection scheme 7-9
- data link
 - MS750 receiver 1-9
 - Trimble radio units 1-9
- data outputs 3-1
- DATA SWITCH 5-7
- DATA TYPE INDICATOR 6-34, 6-36, 6-40, 6-41
- Data/Power Cable 7-2, 8-2, 9-4
 - connecting 7-10
 - connection scheme 7-9
- Data/PPS Cable 7-2, 8-2, 9-4
 - connection scheme 7-9
 - installation 7-11
- DAY OF CREATION 5-14
- DEFAULT application file 4-13
- default application file
 - default.cfg 4-1
- default.cfg application file C-1
- DELAPPPFILE command packet (68h) 5-39
- Delete Application File Data Command
 - Command Packet 68h (DELAPPPFILE) 5-39
- delimiter
 - NMEA
 - checksum 3-3
 - field separator 3-3
- delimiters
 - NMEA
 - start of message 3-1
- DELTA EAST 6-13
- DELTA N 6-37
- DELTA NORTH 6-13
- DELTA UP 6-13
- DELTA X 6-13
- DELTA Y 6-13
- DELTA Z 6-13
- DELTATLS 6-42
- DELTATLSF 6-42

DESTINATION ADDRESS 5-22
 Device Control record
 application file 4-14, 4-16
 data structure 5-21
 DEVICE TYPE 5-13, 5-21, 5-24
 Differential GPS Explained xxiii, 1
 direction
 NMEA field format 3-3
 Directory Lising Report
 Report Packet 67h (RETAFDIR) 6-60
 disclaimer of warranty iii
 DN 6-42
 document conventions xxv
 DOUBLE 4-7
 Data Collector Format 4-8
 overview 4-10
 double data type
 Data Collector Format 4-10
 downloading
 application files 4-1, 4-14

E

Earth-Centered, Earth-Fixed (ECEF) 6-11
 Earth-Centered, Earth-Fixed Delta 6-13
 ECCENT 6-40
 ECCENTRICITY 6-37
 ECEF DELTA (Type 6 Record) 6-13
 ECEF POSITION (Type 3 Record) 6-11
 ECEF X axis delta 6-13
 ECEF Y axis delta 6-13
 ECEF Z axis delta 6-13
 EEPROM (Electrically-Erasable Read-Only Memory) 4-2
 Electrically-Erasable Read-Only Memory (EEPROM) 4-2
 ELEVATION 6-19
 ELEVATION ANGLE 6-46, 6-50

ELEVATION MASK 5-15, 6-29
 elevation mask 1-22
 end transmission
 ETX (03h) 4-4
 ENQ (05h) 4-2
 enviromental factors influencing
 measurement quality 1-23
 EPH WEEK # 6-36
 EPHEMERIS FLAGS 6-34
 EPHEMERIS Report 6-36
 epochs 6-16
 equipment guidance 7-1
 errors
 communications
 RS-232 Serial Interface Specification 4-2
 ETX (03h) 4-4
 Expanded Record Format 6-45
 exponent field
 floating-point data 4-8
 external devices
 connecting 7-9

F

FACTORY CONFIGURATION
 FIRMWARE 2-29
 Options 2-29
 Serial Number 2-29
 factory default values
 default cfg application file 4-1
 FACTORY SETTINGS 5-24
 FACTORY SETTINGS FLAG 5-13
 Fast Update Synchronized RTK (5 Hz)
 positioining mode 1-12
 FASTEST MEAS RATE 6-29
 features
 1 PPS output 1-2
 automatic OTF (on-the-fly)

Index

- initialization 1-2
 - centimeter accuracy 1-2
 - real-time positioning 1-2
- FIFO
 - RS-232 Serial Interface Specification 4-3
- figure of merit numbers 1-2
- file extensions
 - *.cfg C-1
- File Storage record
 - application file 4-14, 4-15
 - data structure 5-14
- File Transfer Protocol (FTP) site xxiv
- First-in, First-out (FIFO)
 - RS-232 Serial Interface Specification 4-3
- FLAG 5-17
- FLAG STATUS 6-46
- FLAGS 5-9, 6-20, 6-37, 6-45, 6-49
- FLAGS1 6-19, 6-46, 6-50
- FLAGS2 6-19, 6-46, 6-50
- FLOAT
 - Data Collector Format 4-9
- float data type
 - Data Collector Format 4-9
- FLOATING-POINT
 - Data Types
 - DOUBLE 4-8
 - overview 4-8
 - SINGLE 4-8
- floating-point data types
 - Data Collector Format 4-8
- FLOW CONTROL 5-16
- format
 - RS232 Serial Interface Specification communications 4-2
- fraction field
 - floating-point data 4-8
- FREQUENCY 5-19
- FREQUENCY OFFSET 6-15, 6-57

- FREQUENCY SOURCE 5-15
- front panel
 - using 7-13
- FULL L1 C/A CODE PSEUDORANGE 6-47, 6-51
- FULL L1 C/A-CODE P-RANGE 6-47
- functions
 - control
 - Data Collector Format 4-5
 - information requests and replies
 - Data Collector Format 4-5

G

- GENERAL CONTROLS
 - ELEV MASK 2-45
 - MEAS RATE 2-45
 - MOTION 2-45
- General Controls record
 - application file 4-14, 4-15
 - data structure 5-15
- General Output Record Reports
 - Report Packet 40h (GENOUT) 6-8
- GENOUT report packet (40h) 6-8
- geodetic database
 - Configuration Toolbox C-5
- GETAFDIR command packet (66h) 5-38
- GETAPFILE command packet (65h) 5-36
- GETOPT command packet (4Ah) 5-5
- GETRAW command packet (56h) 5-8
- GETSERIAL command packet (06h) 5-3
- GETSTAT1 command packet (08h) 5-4
- GETSVDATA command packet (54h) 5-6
- GGA message
 - time, position, and fix related data 3-5, 3-6
- Global Positioning System (GPS) 1-22
- glossary 3
- GPS ICD-200 6-36, 6-40, 6-42

GPS MILLISEC OF WEEK 6-20
 GPS TIME (ms) 6-10
 GPS WEEK NUMBER 6-10, 6-20
 GPS, A Guide to the Next Utility xxiii, 1
 Groundplane 1-25
 GS OF SUBMESSAGE TYPE 5-19
 GST message
 Position Error Statistics 3-8
 GSV message
 Satellite Information 3-9
 guidance
 equipment 1-1, 7-1
 Guide to GPS Positioning 1

H

HDOP 6-14
 HEADING 6-14
 Heading Information
 PTNL,VHD message 3-17
 HEIGHT 6-11
 high update rate 1-1, 7-1
 Home screen 7-17
 Horizontal Dilution Of Precision 6-14
 Horizontal speed 6-14
 HOUR OF CREATION 5-14
 hydrographic surveying 1-1, 7-1

I

I DOT 6-37
 I PPS Output
 device connection 7-9
 I PPS strobe signal 1-2
 I SUB 0 6-37
 Identity Message Format 6-66
 information requests
 report packets 4-5
 INITIALIZATION NUMBER 6-10

initialization time 1-5
 Input Message record
 application file 4-14, 4-16
 inspecting shipment 7-2, 8-2, 9-4
 installation
 Configuration Toolbox C-3
 guidelines 7-4, 8-4, 9-6
 choosing a location 7-4, 9-6
 considering environmental
 conditions 7-4, 9-7
 INTEGER 4-7
 Data Collector Format 4-7
 data types 4-7
 CHAR 4-7
 LONG 4-7
 SHORT 4-7
 integer cycle ambiguity 1-4
 integer data types
 Data Collector Format 4-7
 double
 Data Collector Format 4-10
 float
 Data Collector Format 4-9
 floating-point
 Data Collector Format 4-8
 Intel format
 Data Collector Format 4-7
 IODC 6-36
 IODE 6-36, 6-48, 6-52
 Ionospheric Data 6-42
 IONTIME 6-42
 ISUBO 6-40

J

JX-10 ENABLE FLAG 5-22
 JX-1100 SETUP
 DEST ADR 2-59
 Enable 2-58

LOC ADR 2-58
NETWORK 2-58
PERIOD 2-58
Port 2-58
REPEATER 2-58
RX CHAN 2-59
TX CHAN 2-58

K

KEY ID 5-41
Key ID Codes 5-41
Key Scan Code Simulator
 Command Packet 81h (KEYSIM) 5-41
KEYSIM 6-44
KEYSIM command packet (81h) 5-41

L

L1 carrier measurement 1-5
L1 CONTINUOUS PHASE 6-47, 6-51
L1 DOPPLER 6-47, 6-51
L1 SLIP COUNTER 6-48, 6-52
L1 SNR 6-47, 6-51
L1/L2 OPERATION 6-29
L2 carrier measurements 1-5
L2 CONTINUOUS PHASE 6-47, 6-51
L2 DOPPLER 6-48
L2 P-CODE - L1 C/A CODE P-RANGE 6-47
L2 P-CODE1 - L1 C/A CODE2 P-RANGE 6-51
L2 SLIP COUNTER 6-48, 6-52
L2 SNR 6-47, 6-51
laptop computer
 connection 7-9
LAT, LONG, HEIGHT (Type 2 Record) 6-11

latency
 MS750 receiver 1-7
LATITUDE 6-11, 6-57
latitude
 NMEA field format 3-3
LENGTH 6-4
 Data Collector Format 4-4
limitation of liability iv
limited warranty
 firmware iv
 hardware v
 software iv
LOCAL ADDRESS 5-22
Local Coordinate Position Output
 PTNL,PJK message 3-14
LOCAL DATUM HEIGHT 6-12
LOCAL DATUM ID 6-12
LOCAL DATUM LATITUDE 6-12
LOCAL DATUM LONGITUDE 6-12
LOCAL DATUM POSITION (Type 4 Record) 6-12
LOCAL ZONE EAST 6-12
LOCAL ZONE ID 6-12
LOCAL ZONE NORTH 6-12
LOCAL ZONE POSITION (Type 5 Record) 6-12
LONG 4-7
 Data Collector Format 4-7
LONGITUDE 6-11
longitude
 NMEA field format 3-3
Low Latency mode 1-1, 1-17
Low Latency RTK
 positioning mode 1-13

M

M SUB 0 6-37
MAX PAGE INDEX 6-9
MAXIMUM PAGE INDEX 5-12, 6-61

- Measurement Counting 6-44
 - MEASUREMENT RATE 5-15, 5-25
 - MEASUREMENT STATUS 6-6
 - MEMORY INSTALLED 6-30
 - message ID
 - NMEA 3-3
 - meter-level accuracy 1-5
 - Micro-Centered Antenna 1-25, 7-3, 8-3, 9-5
 - mining equipment positioning 1-1, 7-1
 - MINUTES OF CREATION 5-14
 - mobile receiver (rover) 1-2
 - MODE 5-22
 - MONTH OF CREATION 5-14
 - Motorola format
 - Data Collector Format 4-7
 - mounting
 - antenna 7-6, 9-8
 - receiver 7-5
 - Moving Baseline RTK positioning mode
 - enhancing 1-17
 - Moving Baseline RTK positioning mode 1-16
 - MS750 receiver
 - back panel 7-7, 8-7
 - CAN interface 1-2
 - care 1-3
 - COCOM limits 1-3
 - components 7-2, 8-2, 9-4
 - configuring 7-36
 - connecting power and interface
 - devices 7-9
 - connections 7-7, 8-7
 - data link 1-9
 - features 1-2
 - firmware update A-1
 - front panel
 - using 7-13
 - installation 7-2
 - guidelines 7-4, 8-4, 9-6
 - mounting 7-5
 - NMEA-0183 output 3-1
 - operating range 1-24
 - options and accessories 1-25, 7-3, 9-5
 - overview 1-1
 - physical characteristics 7-66
 - product applications 1-1
 - range checking 4-5
 - reference station coordinate
 - accuracy 1-21
 - RTCM SC-104 input and output 1-2
 - serial ports 1-2
 - standard features 1-2
 - technical specifications 7-67
 - Trimble Format (CMR) input and output 1-2
 - update rate and latency 1-7
 - use 1-3
 - use and care of 1-3
 - MSUBO 6-40
 - multipath errors 1-5
- ## N
- NAK (15h) 4-2, 4-3, 4-5
 - NAME 5-17
 - NaN (Not a Number)
 - floating-point data 4-8
 - NAV PROCESS VERSION 6-4
 - NAVSTAR GPS Space Segment
 - Navigation User Interfaces 2
 - NMEA
 - Common Message Elements 3-3
 - common message elements 3-3
 - message delimiters 3-3
 - message ID 3-3
 - message summary 3-2
 - message values 3-3

- messages
 - GGA 3-5, 3-6
 - GST 3-8
 - GSV 3-9
 - PTNL,GGK 3-10
 - PTNL,GGK_SYNC 3-12
 - PTNL,PJK 3-14
 - PTNL,PJT 3-15
 - PTNL,VGK 3-16
 - PTNL,VHD 3-17
 - VTG 3-18
 - ZDA 3-19
 - NMEA OUTPUT
 - FREQ 2-48
 - PORT 2-48
 - TYPE 2-48
 - NMEA receiver
 - NMEA output 1-2
 - NMEA-0183 OUTPUTS 6-29
 - NODE INDEX 5-17
 - notes xxv
 - NUMBER OF EPOCHS 6-16, 6-17
 - NUMBER OF SVS 6-18, 6-19
 - NUMBER OF SVS USED 6-10
 - number of visible satellites 1-22
- O**
- o configure base tyle
 - 7-58
 - OFFSET 5-19
 - Offset of local oscillator 6-15
 - OMEGA 6-37, 6-40
 - OMEGA DOT 6-37
 - OMEGA SUB 0 6-37
 - OMEGADOT 6-40
 - OMEGSUBO 6-40
 - On-The-Fly (OTF) initialization 1-5
 - On-The-Move initialization 1-5
- operating range
 - MS750 receiver 1-24
 - options and accessories 1-25, 7-3, 8-3, 9-5
 - organization xxi
 - ORIENTATION 6-17
 - OTF (On-the-Fly) initialization 1-2
 - other information xxiv
 - Output Message record
 - application file 4-14, 4-16
 - data structure 5-19
 - OUTPUT MESSAGE TYPE 5-19
 - OUTPUT MESSAGES record
 - application file 4-13
 - output modes
 - Fast CMR 1-17
 - Standard 1-17
 - OUTPUT RECORD TYPE 6-10, 6-11, 6-12, 6-13, 6-14, 6-15, 6-16, 6-17, 6-18, 6-19, 6-20
 - overdetermined positions 6-16, 6-17
- P**
- packet functions
 - Data Collector Format 4-5
 - Packet Paging 6-44
 - packet structure
 - Data Collector Format 4-4
 - packet summary
 - Data Collector Format 4-11
 - PACKET TYPE 6-4
 - Data Collector Format 4-4
 - PAGE INDEX 5-12, 6-9, 6-61
 - PAGING INFO 6-45, 6-49
 - PARITY 5-16
 - parity
 - RS-232 Serial Interface Specification 4-2
 - patents iii
 - P-code 6-38

- P-CODE ON L1 FLAGS 6-35
- PDOP 6-14
- PDOP INFO (Type 9 Record) 6-14
- PDOP MASK 5-15, 6-29
- PERIOD 5-22
- peripherals
 - connecting 7-9
 - connecting laptop computer 7-9
 - connecting TRIMCOMM 900 radio 7-9
- phase ambiguity 1-4
- phase projection
 - for Low Latency RTK solutions 1-14
- pin-out diagrams
 - dual data interface cable 7-73
 - general description 7-68
 - overview 7-68
 - tables 7-68
- platform 1-25
- PORT 5-22, 6-65
- PORT INDEX 5-19
- PORTS AVAILABLE 6-29
- positioning modes
 - Low Latency RTK 1-13
 - summary 1-19
- POSITION
 - HGT 2-16
 - LAT 2-16
 - LON 2-16
 - SVS 2-16
- Position Error Statistics
 - GST message 3-8
- POSITION FIX 6-6
- POSITION FLAGS 1 6-10
- POSITION FLAGS 2 6-10, 6-23
- Position or Real-Time Survey Data Report
 - Report Packet 57h (RAWDATA) 6-43
- Position or Real-Time Survey Data Request
 - Command Packet 56h (GETRAW) 5-8
- POSITION RMS 6-16, 6-17
- POSITION SIGMA INFO (Type 12 Record) 6-17
- POSITION TIME (Type 1 Record) 6-10
- POSITION VCV INFO (Type 11 Record) 6-16
- Positional Dilution Of Precision 6-14
- positioning modes
 - Fast Update Synchronized RTK (5 Hz) 1-12
 - Synchronized RTK (1 Hz) 1-11
- power
 - requirements 7-9
- POWER_UP application file 4-13
- preface xxi
- prevailing atmospheric errors 1-5
- PRN 6-18, 6-19
- Proceedings of the Institute of Navigation 1
- PRODUCT 6-65
- Projection Type
 - PTNL,PJT message 3-15
- Pseudorandom number of satellite 6-18, 6-19
- PTNL,GGK message
 - Time, Position, Position Type, DOP 3-10
- PTNL,GGK_SYNC message
 - Time, Synchronized Position, Position Type, DOP 3-12
- PTNL,PJK message
 - Local Coordinate Position Output 3-14
- PTNL,PJT message
 - Projection Type 3-15
- PTNL,VGK message
 - Vector Information 3-16
- PTNL,VHD message
 - Heading Information 3-17
- PULSE PER SEC 6-30

R

Radio Technical Commission for Maritime
Services (RTCM) 1-9

RANGE 5-23

range checking

MS750 receiver 4-5

RAWDATA report packet (57h) 6-43

reader comment form xxiv

REAL-TIME 17 MESSAGE FLAGS 5-20

Real-Time Kinematic Positioning 1-4

Real-Time Kinematic/On-the-Fly (RTK/
OTF) 1-1

REAL-TIME SURVEY DATA 6-30

RECEIVE CHANNEL 5-22

RECEIVE TIME 6-46, 6-50

Receiver and Antenna Information Report
Report Packet 07h (RSERIAL) 6-3

Receiver and Antenna Information Request
Command Packet 06h
(GETSERIAL) 5-3

receiver configuration 2-1

receiver connections 7-7, 8-7

Receiver Options Parameters Report
Report Packet 4Bh (RETOPT) 6-28

Receiver Options Request
Command Packet 4Ah (GETOPT) 5-
5

receiver screens

1 PPS OUTPUT 2-46

APPLICATION FILE SESSIONS 2-
36

COORDINATE
TRANSFORMATION 2-57

FACTORY CONFIGURATION 2-
29

GENERAL CONTROLS 2-44

JX-1100 SETUP 2-57

NMEA OUTPUT 2-47

POSITION 2-16

RECEIVER SYSTEMS 2-30

SERIAL PORT SETUP 2-55

STORE APPLICATION FILE 2-38

STREAMED OUTPUT 2-49

SV ENABLE/DISABLE 2-43

SV STATUS 2-35

SV TRACKING 2-33

USE FACTORY CONTROLS 2-38

VECTOR 2-18, 2-21

VECTOR AMBIGUITY STATUS 2-
25

VECTOR BASE STATION
STATUS 2-27

RECEIVER SERIAL # 6-4

RECEIVER SERIAL NUMBER (Type 15
Record) 6-20

Receiver Status Report

Report Packet 09h (RECSTAT1) 6-5

Receiver Status Request

Command Packet 08h
(GETSTAT1) 5-4

RECEIVER SYSTEMS

MODE 2-31

OUTPUTS 2-31

RECEIVER TYPE 6-4

Recommendations of Special Committee
104, Differential NAVSTAR/GPS
Service 1

record format

application file 4-15

RECORD INTERPRETATION FLAGS 6-
53

RECORD LENGTH 6-10, 6-11, 6-12, 6-
13, 6-14, 6-15, 6-16, 6-17, 6-18, 6-19,
6-20

RECORD TYPE 6-45, 6-49, 6-52

RECSTAT1 report packet (09h) 6-5

REFERENCE (BASE) NODE RECORD 5-
17

REFERENCE ALTITUDE 5-17

REFERENCE LATITUDE 5-17

- REFERENCE LONGITUDE 5-17
- Reference Node record
 - application file 4-14, 4-15
 - data structure 5-17
- Reference Node Station ID 5-17
- reference phase prediction errors 1-15
- reference station 1-2
- reference station coordinate accuracy 1-21
- Reference Station ID 5-17
- related information xxiii
- Remote Controller software
 - CLEAR key 2-10
 - entering data 2-10
- Removable Groundplane 7-3, 8-3, 9-5
- removeable groundplane 1-25
- REPEATER 5-22
- REPLY # 6-45, 6-49, 6-56
- report packets
 - 07h, R SERIAL 6-3
 - 40h, GENOUT 6-8
 - 55h, RETSVDATA 6-33
 - 6Eh, Break Sequence Return 6-64
 - 82h, SCR DUMP 6-70
- RESERVED 6-47
- RETA FDIR report packet (67h) 6-60
- RETOPT report packet (4Bh) 6-28
- RETSV DATA report packet (55h) 6-33
- RETSV DATA UTC/ION Report 6-41
- revision notice iii
- robotic equipment control 1-1, 7-1
- rover (mobile receiver) 1-2
- RS-232 commands
 - RS-232 Serial Interface Specification 4-2
- RS-232 Serial Interface Specification
 - communications errors 4-2
 - communications format 4-2
 - Data Collector Format 4-1
 - packet structure 4-4
 - packets 4-3
- FIFO 4-3
 - overview 4-1
 - supported baud rates 4-2
 - testing communications link 4-2
- R SERIAL report packet (07h) 6-3
- RTCM FLAGS 5-20
- RTCM INPUT 6-29
- RTCM Input record
 - data structure 5-23
- RTCM OUTPUT 6-30
- RTK
 - critical factors influencing
 - accuracy 1-20
 - error messages 2-24
 - factors contributing to solution
 - latency 1-7
 - further reading 1-24
 - Low Latency mode 1-17
 - number of visible satellites 1-22
 - overview 1-4
 - phase projection for the Low Latency RTK solutions 1-14
 - positioning modes
 - Fast Update Synchronized RTK (5 Hz) 1-12
 - positioning 1-4
 - positioning modes 1-11
 - Low Latency RTK 1-13
 - summary 1-19
 - positioning modes
 - Moving Baseline RTK 1-16
 - Synchronized RTK (1 Hz) 1-11
- RTK
 - positioning modes
 - Moving Baseline RTK 1-16
- RTK BASE STATION
 - ANT. HT. 2-39

- HT 2-39
- LAT 2-39
- LON 2-39
- RTK Fast Static 6-32
- RTK OTF 6-32
- RTK POSITIONING MODE 5-15
- RTK STATION 5-17
- RTK(fixed)
 - solution 1-5
- RTK(float)
 - solution 1-5
- RTK/OTF (Real-Time Kinematic/On-the-Fly) 1-1
- RTK/OTF data 1-2
- RTS/CTS flow control 7-10, 7-11
- Rugged L1/L2 Machine Antenna 1-25, 7-3, 8-3, 9-5

S

- Satellite Information
 - GSV message 3-9
- Satellite Information Reports
 - Report Packet 55h (RETSVDATA) 6-33
- Satellite Information Request
 - Command Packet 54h (GETSVDATA) 5-6
- satellite orbit variations 1-15
- scope xxi
- SCRDUMP command packet (82h) 5-43
- SCRDUMP report packet (82h) 6-70
- Screen Dump
 - Report Packet 82h (SCRDUMP) 6-70
- Screen Dump Request
 - Command Packet 82h (SCRDUMP) 5-43
- screens
 - configuration

- base station 7-53
- base location 7-55
- Port B output 7-62
- contrast 7-19
- GPS 7-39
 - system masks 7-40
 - Port A 7-45
- home 7-17
- status
 - DGPS
 - beacon 7-24, 7-25
 - GPS 7-20
 - DOPs 7-24
 - location 7-20
 - satellite information 7-23
 - velocity 7-22
 - receiver 7-31
 - date and GPS week 7-32
 - firmware version and release date 7-34
 - receiver options 7-35
 - receiver serial number 7-33
 - time 7-31
 - viewing 7-16
- Selective Availability errors 1-15
- SEMI MAJOR AXIS 6-17
- SEMI-MAJOR/MINOR AXES 6-17
- SEMI-MINOR AXIS 6-17
- Semi-minor axis of error ellipse 6-17
- SERIAL NUMBER 6-20
- serial number form B-1, D-1
- Serial Port B-1
 - connecting Data/PPS cable 7-11
- SERIAL PORT BAUD/FORMAT RECORD 5-16
- Serial Port Baud/Format record

- application file 4-14, 4-15
 - data structure 5-16
- SERIAL PORT INDEX 5-16
- SERIAL PORT SETUP
 - BAUD 2-55
 - DATA 2-55
 - FLOW CONTROL 2-55
 - PORT 2-55
- Series 7400 receiver
 - configuring as a rover 8-11
 - menu structure 2-10
- SHORT
 - Data Collector Format 4-7
- SIG PROCESS VERSION 6-4
- SIGMA EAST 6-17
- SIGMA NORTH 6-17
- SIGMA UP 6-17
- sign bit field
 - floating-point data 4-8
- signal degradation 1-24
- Signal-to-noise ratio of L1 signal 6-19
- Signal-to-noise ratio of L2 signal 6-19
- sign-bit field
 - floating-point data 4-8
- SINGLE
 - Data Collector Format 4-8
- SLOT 5-22
- SNR L1 6-19
- SNR L2 6-19
- software
 - Remote Controller 2-2
- solution latency 1-7
 - importance 1-7
- specifications 7-66
 - MS750 receiver 7-67
- SPEED 6-14
- SQRT A 6-37
- SQRTA 6-40
- Standard output mode 1-17
- START APPLICATION FILE FLAG 5-13, 5-24
- start transmission
 - STX (02h) 4-4
- STATIC/KINEMATIC MODE 5-23
- Static/Kinematic record
 - application file 4-14, 4-16
 - data structure 5-23
- STATION ID 5-17, 5-23
- STATUS
 - Data Collector Format 4-4
 - receiver status code 4-4
- status byte
 - Data Collector Format 4-6
- STATUS OF RECEIVER 6-6
- stop bit
 - RS-232 Serial Interface Specification 4-2
- streamed data output format
 - Data Collector Format 4-1
- STREAMED OUTPUT
 - FREQ 2-50
 - OFFSET 2-50
 - PORT 2-50
 - TYPE 2-50
- streamed outputs 1-2
- STX (02h) 4-4
- submeter accuracy 1-2
- SUMMARY OF RTK OPTIONS 6-30
- SV BRIEF INFO (Type 13 Record) 6-18
- SV DETAILED INFO (Type 14 Record) 6-19
- SV ENABLE/DISABLE
 - STATE 2-43
 - SV 2-43
- SV Enable/Disable record
 - application file 4-14, 4-16
 - data structure 5-18
- SV ENABLE/DISABLE STATES 5-18
- SV FLAGS 2 6-9
- SV FLAGS1 6-18

Index

- SV FLAGS2 6-18
 - SV PRN # 5-7, 6-34, 6-36, 6-40, 6-41, 6-46, 6-50
 - Command Packet 54h (GETSVDATA) 5-6
 - SV STATUS
 - ACTIVE 2-35
 - DISABLED 2-35
 - UNHEALTHY 2-35
 - SV TRACKING
 - CH 2-34
 - CODE 2-34
 - EL/AZ 2-34
 - IOD 2-34
 - SNR/L2 2-34
 - SV 2-34
 - URA 2-34
 - SVS DISABLED FLAGS 6-34
 - SVS UNHEALTHY FLAGS 6-34
 - switched power source
 - power requirements 7-9
 - SYNC TIME 6-29
 - synchronized baseline solution 1-16
 - SYSTEM FILE INDEX 5-37, 5-39, 5-40, 6-62
 - system requirements
 - Configuration Toolbox C-2
- T**
- TANGENT PLANE DELTA (Type 7 Record) 6-13
 - TDOP 6-14
 - technical assistance xxiv
 - TGD 6-36
 - time
 - NMEA field format 3-4
 - Time Dilution Of Precision 6-14
 - TIME DIVISION MULTIPLEXING 5-22
 - Time, Position, and Fix Related Data
 - GGA message 3-5, 3-6
 - Time, Position, Position Type, DOP PTNL,GGK message 3-10
 - Time, Synchronized Position, Position Type, DOP PTNL,GGK_SYNC message 3-12
 - tips xxv
 - TOA 6-40
 - TOC 6-36
 - TOE 6-36
 - TOW 6-36
 - tracked satellites 1-2
 - TRACKING L1 FLAGS 6-34
 - TRACKING L2 FLAGS 6-35
 - trademarks iii
 - TRANSMISSION NUMBER 6-9
 - TRANSMIT CHANNEL 5-22
 - transmitting
 - application files C-8
 - Trimble System Controller *See* TSC1 data collector
 - TRIMCOMM 900 1-9
 - connection 7-9
 - TRIMCOMM 900 radio 7-11
 - TRIMTALK 450 1-9
 - TRIMTALK 900 Operation Manual 2
 - True north heading 6-14
 - TSUB0T 6-42
 - TX BLOCK IDENTIFIER 5-12, 6-61
 - Type N-to-N, 15-meter Antenna Cable 1-26, 7-3, 9-5
 - Type N-to-N, 5-meter Antenna Cable 1-26
 - Type N-to-N, 5-meter Antenna Cable 7-3, 8-3, 9-5
 - Type N-to-N, Rugged 30-meter Antenna Cable 1-27, 7-3, 9-5
 - Type N-to-N, Rugged 7.5-meter Antenna Cable 1-26, 7-3, 9-5
 - TYPE RAW DATA 5-9

U

U.S. Department of Commerce 1-3
 UNIT VARIANCE 6-16, 6-17
 Universal Time Coordinated (UTC)
 see UTC
 update notes xxiii
 update rate
 maximum (20 Hz) 1-7
 MS750 receiver 1-7
 updating firmware A-1
 uploading
 application files 4-1, 4-14
 URA 6-38
 User Range Accuracy 6-38
 Using Radio Communication Systems with
 GPS Surveying Receivers 2
 using the front panel 7-13
 UTC
 NMEA time values 3-4
 UTC Data 6-42
 UTC Day, Month, and Year, and Local Time
 Zone Offset
 ZDA message 3-19
 UTC OFFSET 6-20

V

variance-covariance matrix 6-16
 VCV xx 6-16
 VCV xy 6-16
 VCV xz 6-16
 VCV yy 6-16
 VCV yz 6-16
 VCV zz 6-16
 VDOP 6-14
 VECTOR
 DOP 2-23
 E 2-18, 2-22
 Fix Mode 2-22

N 2-18, 2-22, 2-23
 PROP 2-22
 R 2-22
 RMS 2-22
 U 2-18, 2-22

VECTOR AMBIGUITY STATUS

L1,L2 2-26
 RATIO 2-26
 REF SV 2-26
 RMS 2-26
 SV 2-26

VECTOR BASE STATION STATUS

AGE 2-28
 HGT 2-28
 LAT 2-28
 LON 2-28
 NAME 2-28
 SVS 2-28

Vector Information

PTNL,VGK message 3-16

VELOCITY DATA (Type 8 Record) 6-14**VELOCITY FLAGS 6-9, 6-14****Velocity status 6-14****VERSION 6-65****Vertical Dilution Of Precision 6-14****VERTICAL VELOCITY 6-14****Vertical velocity 6-14****VGT message**

Actual Track Made Good Over and
 Speed Over Ground 3-18

viewing

Antenna Type screen 7-43
 application file
 default application file 7-18
 Configure Base Type screen 7-58

W

warnings xxv

Index

WGS-84 ECEF X-axis coordinate 6-11
WGS-84 ECEF Y-axis coordinate 6-11
WGS-84 ECEF Z-axis coordinate 6-11
WNSUBLSF 6-42
WNSUBT 6-42
World Wide Web (WWW) site xxiv

X

X 6-11

Y

Y 6-11
Y-code 6-38
Y-CODE FLAGS 6-35
YEAR OF CREATION 5-14

Z

Z 6-11
ZDA message
 UTC day, month, and year, and local
 time zone offset 3-19

