

# GeoSWITCH Amazone



**Version 7.41 rev. 2**

## About this manual

This user manual is specially designed to detail the device's functions and features. Please read this manual before using the device to ensure safe and proper use.

Descriptions are based on the device's default settings.

Images and screenshots may differ in appearance from the actual product.

Content may differ from the final product, or from software and is subject to change without prior notice.

Available features and additional services may vary by device, software, or subscriptions.

## What's in the box

- ✓ GeoSWITCH unit
- ✓ Adapter cable

## System requirements

- ✓ Only Amazone sprayers are supported
- ✓ Amazone fw on Jobcom should be version 6 or higher
- ✓ Amazone fw on terminal should be 3.23 or higher
- ✓ If you use a TmX-2050 Precision IQ application, a Joystick is necessary
- ✓ If you use a TmX-2050 display a port expander (EXP-100) is necessary.
- ✓ The sprayer is NOT working on ISO-bus, only Amabus is supported
- ✓ The GeoSWITCH can't work in combination with the Amazone AmaClick

## Safety instructions

Please make sure that you always follow the instructions on the note "Caution". The information provided is intended to minimize the risk of personal injury and / or property damage. Please be aware that you're responsible for your and others' safety. Please respect the safety instructions listed in this manual.

**Note** - An absence of specific (audible) alerts does not mean there's no security risk.

The supplier is not liable for any personal or material damage caused while using the system.

## Copyright

Copyright © 2017 Agrometius. This guide is protected under international copyright laws. No part of this guide may be reproduced, distributed, translated, or transmitted in any form or by any means, electronic or mechanical, including photocopying, recording, or storing in any information storage and retrieval system, without the prior written permission of Agrometius.

**Table of contents**

- 1. Cabling GeoSWITCH to a Trimble CfX-750 or FmX display..... 4**
- 2. Cabling GeoSWITCH to a Trimble TmX-2050 display ..... 5**
- 3. GeoSWITCH for Precision IQ app (TmX-2050)..... 6**
  - 3.1 Program GeoSWITCH for Precision IQ app ..... 7
  - 3.2 Summary configuration GeoSWITCH on Precision IQ..... 9
- 4. GeoSWITCH for FmX and FmX+ (TmX-2050)..... 10**
  - 4.1 Starting configuration cycle .....10
  - 4.2 Configuration cycle number of sections .....10
  - 4.3 Configuration cycle general section width.....10
  - 4.4 Configuration individual section widths .....10
  - 4.5 Configuration cycle application mode .....11
  - 4.6 Finalizing the configuration cycle.....11
- 5. GeoSWITCH for CfX-750..... 12**
  - 5.1 Starting configuration cycle .....12
  - 5.2 Configuration cycle number of sections .....12
  - 5.3 Configuration cycle general section width.....12
  - 5.4 Configuration individual section widths .....13
  - 5.5 Configuration cycle application mode .....14
  - 5.6 Finalizing the configuration cycle.....14
- 6. Configuring the Amatron..... 15**
  - 6.1 Joystick .....15
- 7. Trouble shooting..... 16**
  - 7.1 FmX, CfX, TmX-2050 FmX plus app .....16
  - 7.2 Diagnostics GeoSWITCH on TmX-2050 Precision IQ .....16
  - 7.3 Amatron+ diagnostics.....17
  - 7.4 Auxiliary Master Switch .....18
    - 7.4.1 FmX, CfX, TmX-2050 FmX plus app .....18
    - 7.4.2 TmX-2050 Precision IQ .....18

## 1. Cabling GeoSWITCH to a Trimble CfX-750 or FmX display

From the GeoSWITCH seen, connect the 12 pin Deutsch connector to the Trimble CfX port A. If you use a FmX display you can use port A or port B. Connect the serial connector on the other cable from the GeoSWITCH to the Amazone Amatron terminal. Use the most left connector on the Amatron (ASD). The 4 pin Deutsch can be connected to the adapter cable. Install the adapter cable between the Amatron cabin cable. If there is no joystick the Adapter cable can be fitted straight in the middle of the Amatron.

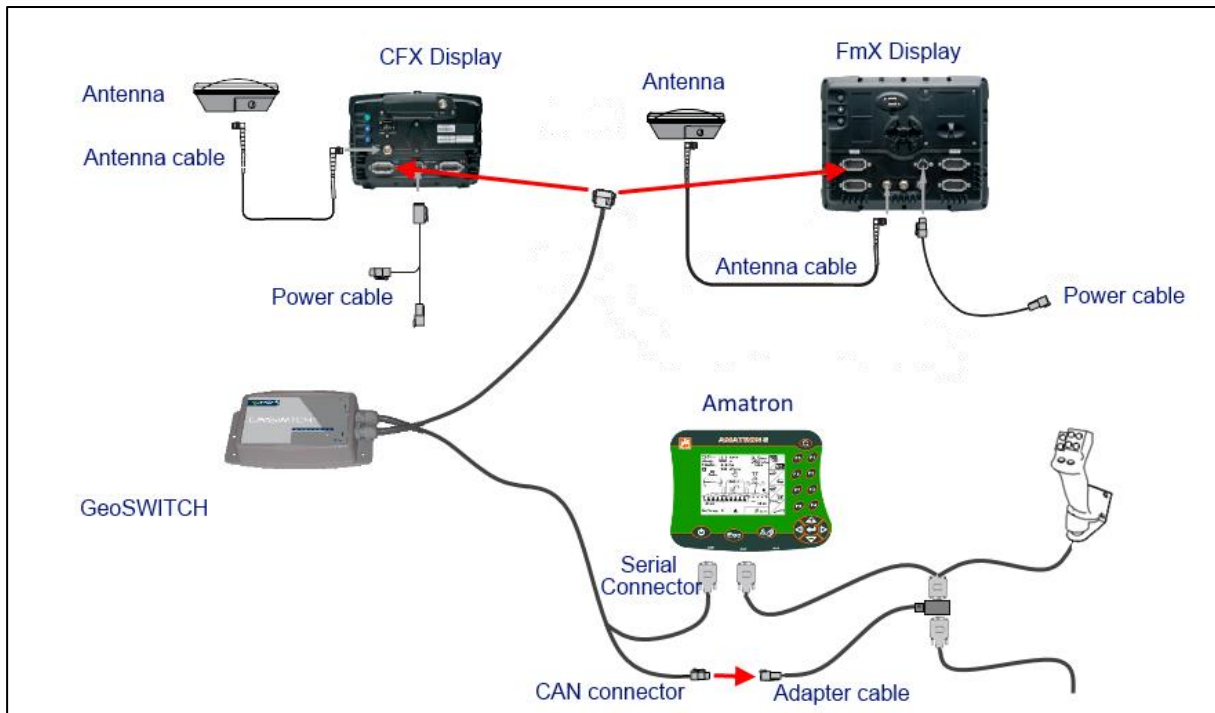

The display must be unlocked for Variable Rate Application (VRA). In some firmware versions it's called Serial Rate Control.

**Note** – By sure the units are set to kg/ha and not lbs/acre.

## 2. Cabling GeoSWITCH to a Trimble TmX-2050 display

For installation a GeoSWITCH to your TmX-2050 display a port expander is necessary. The GeoSWITCH 12 pins Deutsch connector can directly plugged into the port expander. When you use the FmX + application, it's required the port expander is setup the right way. Please check the Trimble manual for advice.

Connect the serial connector on the other cable from the GeoSWITCH to the Amazone Amatron terminal. Use the most left connector on the Amatron (ASD). The 4 pin Deutsch can be connected to the adapter cable. Install the adapter cable between the Amatron cabin cable. If there is no joystick the Adapter cable can be fitted straight in the middle of the Amatron.

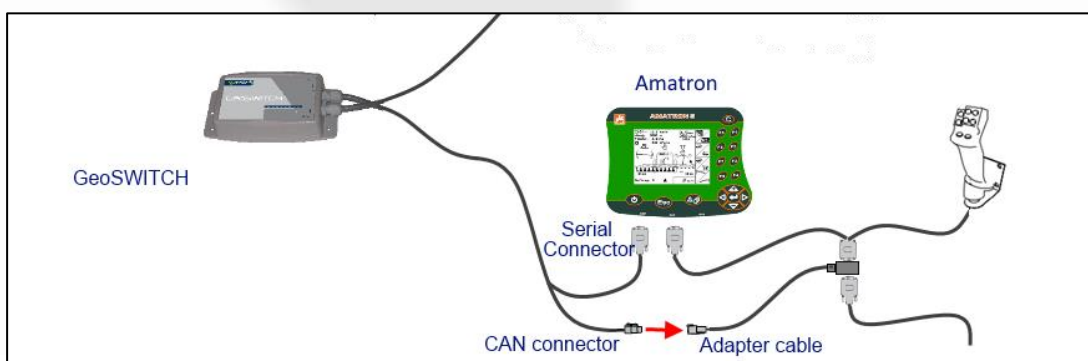
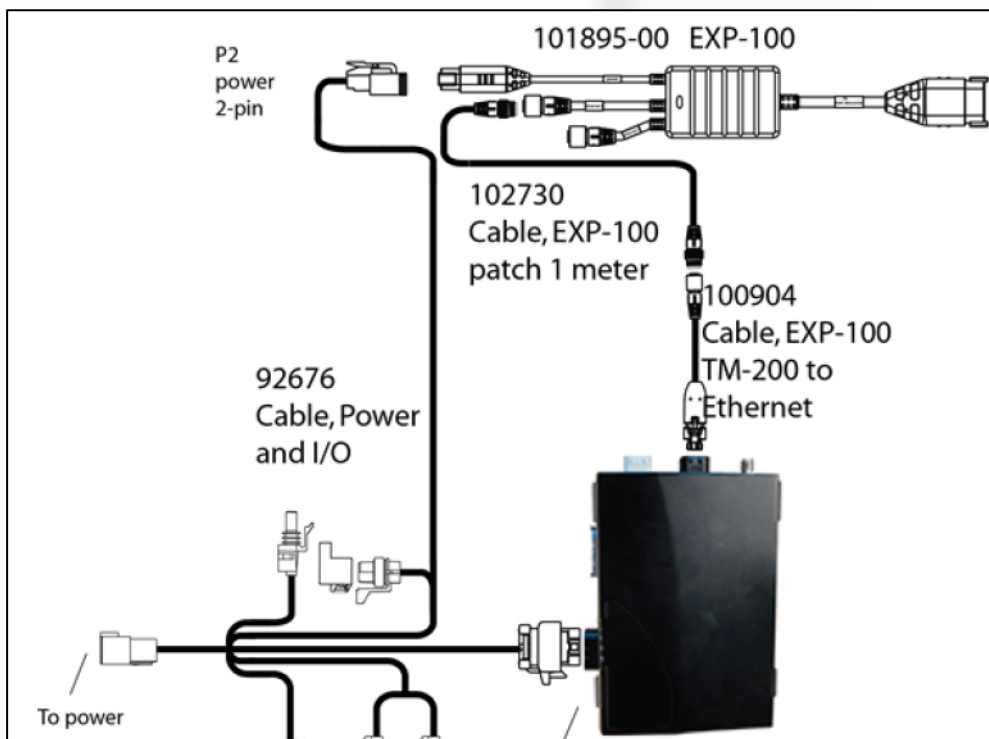

The display must be unlocked for Variable Rate Application (VRA). In some firmware versions it's called Serial Rate Control. There are different codes for FmX+ and Precision IQ.

**Note** – Be sure the units are set to kg/ha and not lbs/acre.

### 3. GeoSWITCH for Precision IQ app (TmX-2050)

At the home screen tap  for the implement setup.

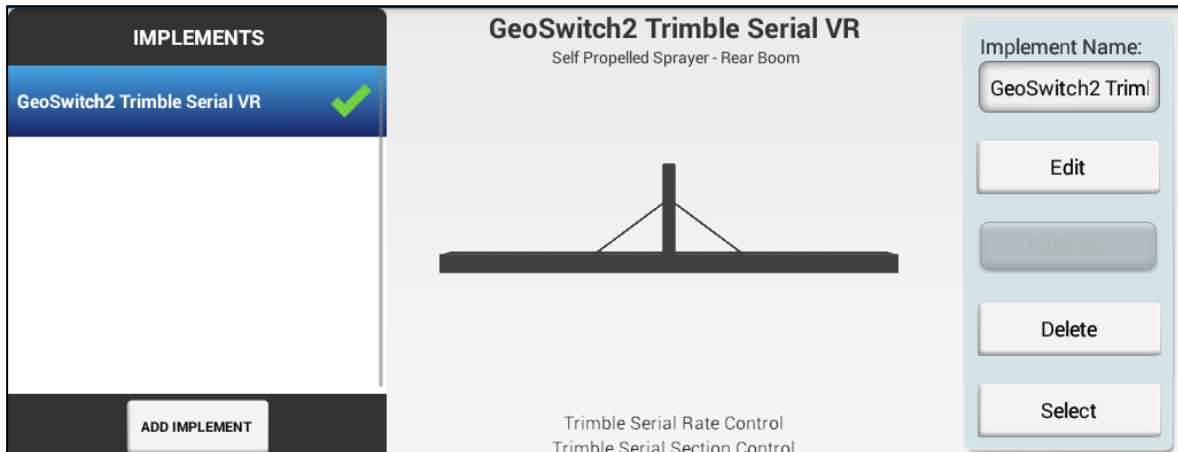

Tap add implement.

Depending your TmX-2050 firmware version you will go through several set-up screens. Choose one of the following operations:

- Sprayer

Choose at application control type: Trimble serial VR



Choose at serial port device: EXP-100. This is recognizable by serial number. For example 5604H00082

Save these settings. The TmX will close the screen and starts loading settings from the connected Trimble serial VR controller. (in this case the GeoSWITCH). After that the TmX re-opens the implement configuration with the new settings.

Continue the implement setup wizard. When finished store the settings and push the return button on the bottom of the screen. .

Select the 'new' implement. The TmX will load the settings and display a message when the device is ready to use.

Exit the implement settings with the return button  at the bottom

At the home screen tap . The material setup panel displays. Create or select a material. When finished press the return button  at the bottom of the screen.

Open a field. If not displayed the VR widget you can add this at the widgets .

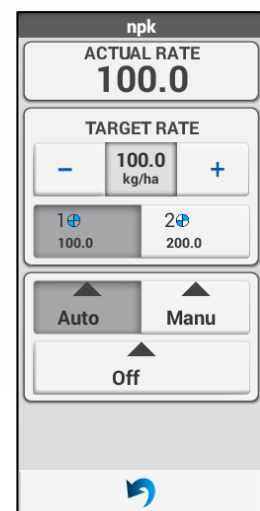

### 3.1 Program GeoSWITCH for Precision IQ app

Open a field. The GeoSWITCH can be configured by changing the target rates. Press the application navigation button  at the bottom of the screen.



Select the PIQ home screen. Open the material configuration. Open the material library. Select the material and edit the material.

Set max rate at 1000000 and units to Metric. (l/ha, kg/ha etc. )

Set target rate 1 at 999999 (start configuration)

Set target rate 2 at 9999xx xx = number of sections. Values should be between 01 and 13. Thus 999901 to 999913. Save the changes.

Press Application navigation button 

Select PIQ run screen. Fold out the VRA widget.

Select Target rate 1. Actual rate should show 999999. The GeoSWITCH is available for configuration.

Select Target rate 2. Actual rate should show 9999xx The GeoSWITCH will set the number of sections.

Press Application navigation button 

Select the PIQ home screen with open material library and select material.

Edit material.

Set target rate 1 at 99yyyy yyyy = the general section width in cm's. Values should be between 0001 and 8999. Thus 990001 to 998999

If there are sections with different width...

Set target rate 2 at 9xxzzz xx = number of variant section (between 01 and 13)

Yyy = the width of this section in cm's. (between 001 and 999)

Press Application navigation button 

Select the PIQ run screen. Fold out the VRA widget.

Select Target rate 1 of 99yyyy. The GeoSWITCH sets all sections at width yyyy

If necessary select Target rate 2 of 9xxyyy the GeoSWITCH will set section xx at yyy width.

**Note** – Always set the general width before individual widths.  
Repeat all above steps until all sections are configured correctly.

---

Press Application navigation button 

Select the PIQ home screen with open material library and select material.  
Edit material.

Set target rate 1 at 99999z          z = application mode

1. = liquid l/ha

Press Application navigation button 

Select the PIQ run screen. Fold out the VRA widget.

Select Target rate 1 of 99999z. The GeoSWITCH sets the application mode.

---

Press Application navigation button 

Select the PIQ home screen with open material library and select material.  
Edit material.

Set target rate 2 at 888888          (stop configuration)

Press Application navigation button 

Select the PIQ run screen. Fold out the VRA widget.

Select Target rate 1 of 888888. The GeoSWITCH will end configuration and reboot with the new settings.



### 3.2 Summary configuration GeoSWITCH on Precision IQ

Target Rate	Description
999999	GeoSWITCH enters TMX configuration mode
9999xx	The GeoSWITCH will set xx number of sections. xx may have any values between 01 and 13 thus 999901 to 999913
99yyyy	The GeoSWITCH will set yyyy as the general section width in cm's. values should be between 0001 and 8999 thus 990001 to 998999
9xxyyy	The GeoSWITCH will set yyy as the section width in cm's for section xx. xx may have any values between 01 and 12 thus 901yyy to 912yyy yyy may have any values between 001 and 999 thus 9xx001 to 9xx999
99999z	The GeoSWITCH will set the Application mode z 1 is for liquid application l/ha.
888888	The GeoSWITCH will end the configuration and reboot with the new settings

## 4. GeoSWITCH for FmX and FmX+ (TmX-2050)

While the GeoSWITCH receives no basic settings from the implement it self you can enter these. The configuration routine is a cycle. You must cycle through it a few times. Changing one setting is not possible. If you want to change a setting you have to go through the whole procedure again.

### 4.1 Starting configuration cycle

Tap on configuration  to get to the configuration menu. There you select Serial Rate Control and tap on Setup.

In this screen set the Default Rate to 9999. Continue by tapping 2x on OK. Open a field. You confirm any possible user messages/warnings and in the Serial Rate Control tab you verify if an Actual Rate of 9999 is displayed.

You proceed by closing the field and then returning to the configuration menu.

### 4.2 Configuration cycle number of sections

Select Serial Rate Control and tap on Diagnostics.

Behind Name implement should be displayed “#Sections?”. Tap on OK to return to the configuration menu. With Serial Rate Control still selected, tap on Setup.

Set the Default Rate to the number of sections, for example 8 (minimum 1, maximum 13).

Continue by tapping twice on OK to return to the home screen. Open a field. Confirm any possible user messages/warnings and in the Serial Rate Control tab you verify if the Actual Rate is displaying the correct number of sections.

Proceed by closing the field and then returning to the configuration menu.

### 4.3 Configuration cycle general section width

Select Serial Rate Control and tap on Diagnostics.

Behind Name implement should be displayed “Sect.Width”. Tap on OK to return to the configuration menu. With Serial Rate Control still selected, tap on Setup.

Set the Default Rate to the most common section width in centimeters:

- 3 meter section width is 300 cm
- With only 1 section this would be the whole working width
- At this moment all sections are given the same width. The differing sections widths are configured later on..

Continue by tapping twice on OK to return to the home screen. Open a field. Confirm any possible user messages/warnings and verify if in the Serial Rate Control tab the Actual Rate is displaying the correct section width. Proceed by closing the field and then returning to the configuration menu.

### 4.4 Configuration individual section widths

Select Serial Rate Control and tap on Diagnostics.

Behind “Name implement should be displayed “SectionNR?”. Proceed to enter the section number of which you want to change the width. With Serial Rate Control still

selected, tap on “Setup”. Set the Default Rate to the section number of which you want to change the width.

Continue by tapping twice on OK to return to the home screen.

Open a field. Confirm any possible user messages/warnings and verify if in the Serial Rate Control tab the Actual Rate is displaying the correct section number. Proceed by closing the field and then returning to the configuration menu.

Select Serial Rate Control and tap on Diagnostics. Behind Name implement should be displayed “Width nrX” or “Width #XX Proceed to enter the section width. Tap twice on OK to return to the configuration menu. With Serial Rate Control still selected, tap on Setup. Set the Default Rate to the desired section width in centimeters:

Continue by tapping twice on OK to return to the home screen.

Open a field. Confirm any possible user messages/warnings and verify if in the Serial Rate Control tab the Actual Rate is displaying the correct section width.

Proceed by closing the field and then returning to the configuration menu.

Continue this cycle until all differing section widths are set correctly.

When all sections are configured, enter section number “14” (maximum + 1). Tap on OK to return to the configuration menu.

#### 4.5 Configuration cycle application mode

Select Serial Rate Control and tap on Diagnostics.

Behind “Name implement:” should be displayed “Appl.Mode?”. Proceed to enter the application mode. Tap on OK to return to the configuration menu. With Serial Rate Control still selected, tap on Setup. To set the application mode you enter a Default Rate of:

1. = for sprayers - L / ha

Continue by tapping twice on “OK” to return to the home screen.

Open a field and confirm any possible user messages/warnings. In the Serial Rate Control tab you verify if the Target Rate is displaying the mode number.

**Note** – the Actual Rate will be displaying zero.

Proceed by closing the field and then returning to the configuration menu.

#### 4.6 Finalizing the configuration cycle

Select Serial Rate Control and tap on Diagnostics. Behind Name implement should be displayed “AmazoneSw”\*\*. The configuration is complete and you can proceed to enter the real Default Rate. Tap on “OK” to return to the configuration menu.

With “Serial Rate Control” still selected you tap on “Setup”. In the screen “Edit Variable Rate controller settings” you choose the tab Rate and set the Default Rate to the desired value. Continue by tapping twice on OK to return to the home screen.

(\*\*) when the Amatron display is present on the CAN-bus than the implement name should display “AmazoneSw”. “No Amazone” is displayed if the GeoSWITCH is not getting serial communication from the Amatron.

## 5. GeoSWITCH for CfX-750

While the GeoSWITCH receives no basic settings from the implement it self you can enter these. The configuration routine is a cycle. You must 4 times go through it. Changing one setting is not possible. If you want to change a setting you have to go through the whole procedure again.

**Note** – Make sure you have a valid GPS signal and a valid field is opened.

### 5.1 Starting configuration cycle

Tap on “**Quick Access**”  to get in the *Quick Access menu*.

There you select “**Target Rate**”. In the menu screen “**Target Rate**” you enter “**9999**”.

Tap on  and consequently on  to return to the work screen.

You confirm any possible user messages/warnings and verify if in the implement status bar the Target Rate of 9999 is displayed behind the “**T**” and “**A**”.

### 5.2 Configuration cycle number of sections

In the Settings/Implement/ Application Control/Advanced/Status menu “**#Sections?**” must be displayed on the 2<sup>e</sup> line behind “**Name**” . You can proceed to enter the number of sections.

Tap on  and consequently on  to return to the work screen.

Tap on “**Quick Access**”  to get in the *Quick Access menu*.



There you select “**Target Rate**”.

In the menu screen “**Target Rate**” you enter the number of sections, for example “**8**” (minimum 1, maximum 13). Be sure the units are **kg NH3/ha** and **not kg N/ha**. Tap on

 and consequently on  to return to the work screen.

You confirm any possible user messages/warnings and verify if in the implement status bar the number of sections is displayed behind the “**T**” and “**A**”.

### 5.3 Configuration cycle general section width

In the Settings/Implement/Application Control/Advanced/Status menu “**Sect.Width**” must be displayed on the 2<sup>e</sup> line behind “**Name**” . You can proceed to enter the most common Section Width. Tap on  and consequently on  to return to the work screen.

Tap on “**Quick Access**”  to get in the *Quick Access menu*.

There you select “**Target Rate**”.



In the menu screen “**Target Rate**” you enter the section width in centimeters:

- 3 meter section width is 300 cm
- Width only 1 section this would be the whole working width
- At this moment all sections are given the same width. The differing sections widths are configured later on..

Tap on  and consequently on  to return to the work screen.



You confirm any possible user messages/warnings and verify if in the implement status bar the section width is displayed behind the “T” and “A”.

#### 5.4 Configuration individual section widths



In the Settings/Implement/ Application Control/Advanced/Status menu “**SectionNR?**”. most be displayed on the 2<sup>e</sup> line behind “**Name**” . Proceed to enter the section number of which you want to change the width. . Tap on  and consequently on  to return to the work screen.

Tap on “**Quick Access**”  to get in the *Quick Access menu*.

There you select “**Target Rate**”.

In the menu screen “**Target Rate**” you enter to the section number of which you want to change the width, for example “**8**” (minimum 1, maximum 13). Tap on  and consequently on  to return to the work screen.

You confirm any possible user messages/warnings and verify if in the implement status bar the section number is displayed behind the “T” and “A”.

In the Settings/Implement/Application Control/Advanced/Status menu “**Width nrX**” or “**Width #XX**” must be displayed on the 2<sup>e</sup> line behind “**Name**” . Proceed to enter the section width. Tap on  and consequently on  to return to the work screen.

Tap on “**Quick Access**”  to get in the *Quick Access menu*.

There you select “**Target Rate**”.

In the menu screen “**Target Rate**” you enter the section width in centimeters:



Tap on  and consequently on  to return to the work screen.

You confirm any possible user messages/warnings and verify if in the implement status bar the section width is displayed behind the “T” and “A”.

Continue this cycle until all differing section widths are set correctly.

When all sections are configured, enter section number “**14**” (*maximum + 1*). Tap on “**OK**” to return to the configuration menu. Proceed with configuration of the application mode.

## 5.5 Configuration cycle application mode

In the Settings/Implement/Application Control/Advanced/Status menu “**Appl.Mode?**” must be displayed on the 2<sup>e</sup> line behind “**Name**” . You can proceed to enter the application mode. Tap on  and consequently on  to return to the work screen.

Tap on “**Quick Access**”  to get in the *Quick Access menu*.

There you select “**Target Rate**”.

In the menu screen “**Target Rate**” you set the application mode by entering a “**Target Rate**” of:

1. =      for sprayers - L / ha

Tap on  and consequently on  to return to the work screen.

You confirm any possible user messages/warnings and verify if in the implement status bar the applicatie mode is displayed behind the “**T**” (NB: the **Actual Rate** will be displaying zero).

## 5.6 Finalizing the configuration cycle

In the Settings/Implement/Application Control/Advanced/Status menu “**AmazoneSw**” \*\* must be displayed on the 2<sup>e</sup> line behind “**Name**” . Then configuration is complete and you can proceed to enter the real “**Target Rate**”.

Tap on  and consequently on  to return to the work screen.

Tap on “**Quick Access**”  to get in the *Quick Access menu*.

There you select “**Target Rate**”.

In the menu screen “**Target Rate**” you set the “**Target Rate**” to the desired value.

Tap on  and consequently on  to return to the work screen.

(\*\*) when the Amatron display is present on the CAN-bus than the implement name should display “AmazoneSw”. “No Amazone” is displayed if the GeoSWITCH is not getting serial communication from the Amatron

## 6. Configuring the Amatron.

The Amatron display must operate as an Amabus terminal. The ASD serial input must be set to a baudrate of 57600. If you have problems setting your Amatron refer to the Amatron user's manual or your Amazone Service center.

### 6.1 Joystick

There are three type of Amazone joysticks:

**Note** – Only the Can-bus Joysticks will work in combination with the GeoSWITCH.

**Note** – If you use the TmX-2050 with Precision IQ app you need always a Joystick.

Type 1, No Can-bus Joystick. Recognizable by the missing led in the middle.  
This one will NOT work in combination with GeoSWITCH.



Type 2, Can-bus Joystick.

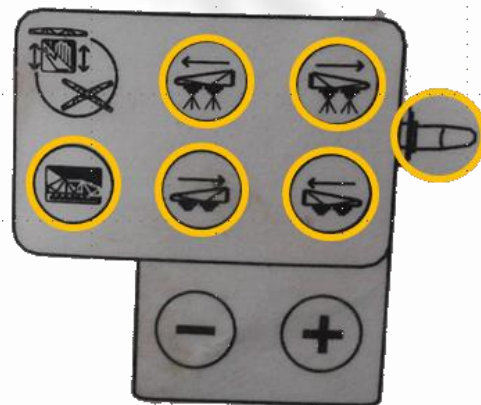

Type 3, Can-bus Joystick AmaPilot

**Note** – The Joystick must be in standard configuration.



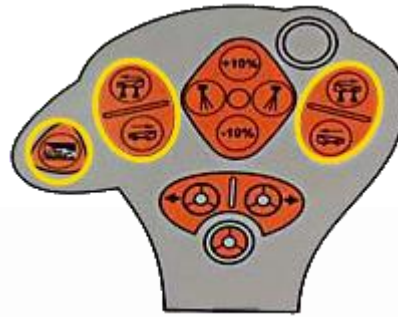

The GeoSWITCH can work with the Amazon joysticks to operate the master switch and switches to enable/disable sections.

**Note** – If you use the joystick in combination with the TmX-2050 with FmX+ app, FmX or CfX-750, the Remote Master Switch option (log-Button) must be disabled in the Trimble Serial Rate Settings.

## 7. Trouble shooting

### 7.1 FmX, CfX, TmX-2050 FmX plus app

If “No Amazone” is displayed the GeoSWITCH is not getting serial commands from the Amatron. If you want to disable this you enter by targetrate 9999.9 “Amazone-RS” is then displayed.

### 7.2 Diagnostics GeoSWITCH on TmX-2050 Precision IQ

In the system performance diagnostic screen you must see the port expander (EXP-100)

Title	Firmware Version	Serial Number	Connected
TMX-2050	4.5.1.58	5406500181	Yes
EXP-100	2.50.007.4	5604H00082	Yes
NAVCONTROLLER III	12.50.006.4	5611550005	Yes
serial_vr	06.87.000.0	GeoSwitch2_06_87_000_0	Yes
TM-200	5.30.002.4	5613550420	Yes

In the serial variable rate diagnostic screen, the status of the GeoSWITCH is visible.





Precision-IQ		Status
Performance		Status Connected
Logging		Name GeoSwitch2
Autopilot		FW Version 06.87.000.0
Performance		Device Protocol 01.02.001.4
GNSS Receiver		Display Protocol 01.05.003.0
Performance		Rate Control Allowed
Connectivity		Section Control Allowed
OfficeSync		Mode Spreading
ISOBUS		Fence Sections None
		Boom Width 18.0
		Number Of Sections 5
		Number Of Switches 5

### 7.3 Amatron+ diagnostics

#### 5.6 Terminal-Setup

Im Menü Setup:

Um die Einstellungen des Displays zu verändern, folgende Tasten gleichzeitig betätigen:

-  Blättern
-  Shift

- Rufen Sie über das Funktionsfeld  die Eingabe "Display Einstellungen" auf.

-  Anzeigen der am Bus befindlichen Geräte.

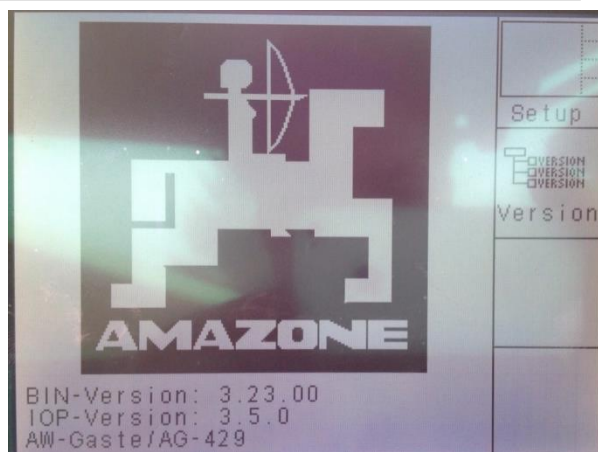
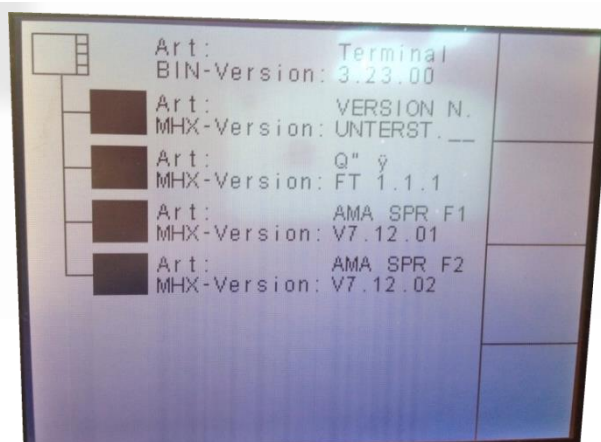

Fig. 73

Known working firmware is 3.23

When you press the "VERSION" button the sprayer controllers firmware versions become visible.



## 7.4 Auxiliary Master Switch

### 7.4.1 FmX, CfX, TmX-2050 FmX plus app

On the GeoSWITCH no main switch is available, we can use the log button as Auxiliary Master Switch. The GeoSWITCH tells the Trimble display of the Auxiliary Master Switch (log Button) is allowed or not. If the use is not allowed then the Log-Button cannot be turn on in VRA configuration menus on the FmX, CfX and TmX-2050 FmX+ display.

To allow the use of the Auxiliary Master Switch (log Button):

Enter Rate: 7777.7 (and open field on FmX) then reset rate to normal desired value.

To forbid the use of the Auxiliary Master Switch (log Button):

Enter Rate: 6666.6 (and open field on FmX) then reset rate to normal desired value.

**Note** – If you use an Joystick, the Remote Master Switch option (log-Button) must be disabled in the Trimble Serial Rate Settings.

### 7.4.2 TmX-2050 Precision IQ

On the GeoSWITCH is no main switch available. On PIQ is it NOT possible to configure an Auxiliary Master Switch. So a Joystick is needed always to operate as main switch. So the external master must be always disabled. If it won't work try to set 6666.6

## Agrometius

NL +31 88 818 0 818  
BE +32 11 599 566  
DE +49 2923 971 59 59

[info@agrometius.com](mailto:info@agrometius.com)  
[www.agrometius.com](http://www.agrometius.com)

